

Nice

BiDi-Shutter

Interior bidirectional interface for tubular motor

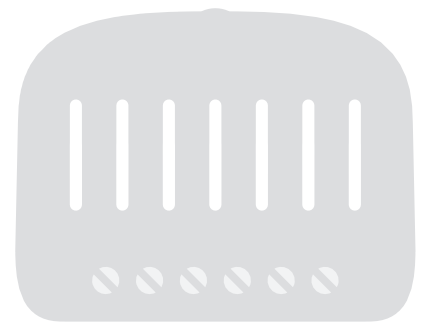

EN - Instructions and warnings for installation and use

Nice

1 WARNINGS AND GENERAL PRECAUTIONS

- **CAUTION! – This manual contains important instructions and warnings for personal safety.** Carefully read all parts of this manual. If in doubt, suspend installation immediately and contact the Nice Technical Assistance.
- **CAUTION! – Important instructions: keep this manual in a safe place to enable future product maintenance and disposal procedures.**
- **CAUTION! – All installation and connection operations must be performed exclusively by suitably qualified and skilled personnel with the unit disconnected from the mains power supply.**
- **CAUTION! – Any use other than that specified herein or in environmental conditions other than those stated in this manual is to be considered improper and is strictly forbidden!**
- This product may only be used indoors or protected from weather conditions by control unit's housing.
- The product's packaging materials must be disposed of in full compliance with local regulations.
- Do not open the device protection housing as it contains non-serviceable electrical circuits.
- Never apply modifications to any part of the device. Operations other than those specified may only cause malfunctions. The manufacturer declines all liability for damage caused by makeshift modifications to the product.
- Never place the device near to sources of heat and never expose to naked flames. These actions may damage the product and cause malfunctions.
- This product is not intended for use by people (including children) with reduced physical, sensory or mental capabilities or who lack experience and knowledge, unless they have been given supervision or instruction concerning the use of the product by a person responsible for their safety.
- Make sure that children do not play with the product.
- Check the warnings in the instruction manual for the motor that the product is connected to.
- Handle the product with care, being sure not to crush, knock or drop it in order to avoid damage.

2 PRODUCT DESCRIPTION

The BiDi-Shutter control unit enables the control of a single-phase asynchronous motor, mains powered, with connection types: Down, Common, Up, used for the automation of awnings, rolling shutters, Venetian blinds and similar.

The BiDi-Shutter control unit incorporates a radio transceiver that operates at the frequency of 433.92 MHz with rolling code technology to guarantee optimal safety levels.

Each control unit can memorise up to 30 mono or bidirectional transmitters in the series ERA, ERGO, FLOR, NICEWAY and VERY, which enable the remote control of the unit.

In the 30 transmitters, climatic radio sensors can be memorised, for the automatic control of the control unit according to weather conditions.

The control unit is equipped with two inputs for controlling the unit by means of external pushbuttons. Memorisation and programming is possible via the programming pushbutton (figure 1) on the BiDi-Shutter. The user is guided through the various phases by means of LED signals.

The control unit is equipped with overload, and overheating protection, which will disable the relays to prevent damage to the circuit.

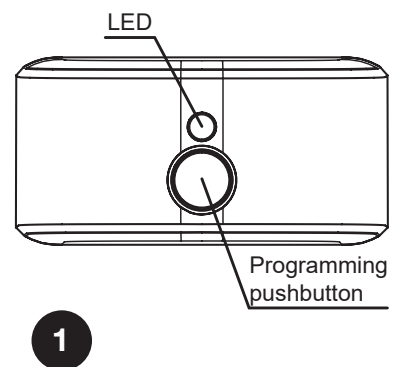

3 INSTALLATION



- **The product is subject to hazardous electric voltages**
- **The installation of the BiDi-Shutter and automations must be performed exclusively by technically qualified personnel, in observance of current legislation and standards, and according to these instructions. All connections must be made with the system disconnected from the power supply.**
- **The BiDi-Shutter control unit has been especially designed for insertion in a junction box or wall box; its housing does not feature any protection against water and only basic protection against contact with solid parts. Never place the BiDi-Shutter in inadequately protected environments.**
- **Never open or perforate the BiDi-Shutter housing, this is subject to hazardous electric voltages!**

3.1 - Preliminary checks

- The power supply line must be protected by suitable magneto-thermal (compliant with IEC/EN 60898-1 standard, rated up to 16A) and residual-current circuit breakers.
- A disconnection device must be inserted in the power supply line from the electrical mains (the distance between the contacts must be at least 3mm with an overvoltage category of III) or equivalent system, for example an outlet and relative plug. If the disconnection device for the power supply is not mounted near the automation, it must have a locking system to prevent unintentional, unauthorized connection.

3.2 - Electrical connections

⚠ ⚠ Carefully follow all the connection instructions. If you have any doubts do not make experiments but consult the relevant technical specifications which are also available on the web site: www.niceforyou.com. An incorrect connection may be dangerous and cause damage to the system.

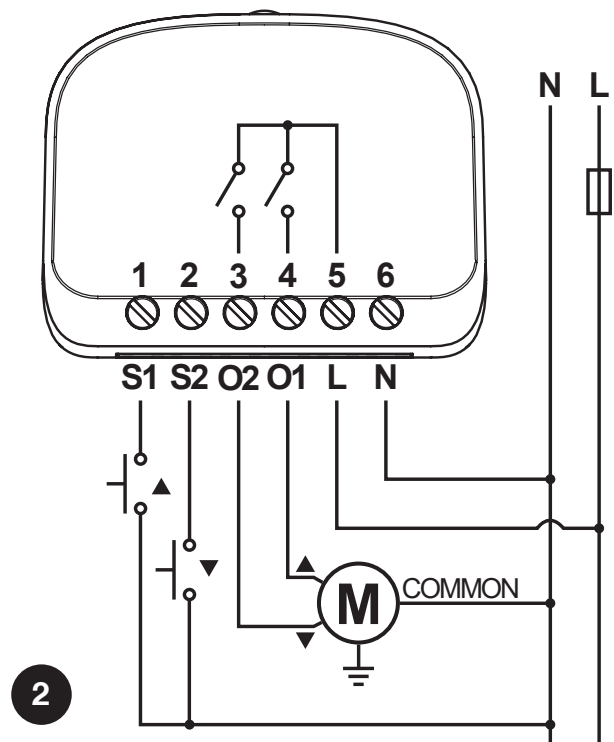

3.3 - Motor connection

The single phase asynchronous motor connection to the mains must be via terminals O1-N-O2 (Up, Common, Down). Up corresponds to the key ▲ of the transmitters and S1 pushbutton, Down to key ▼ and S2 pushbutton. After connecting, if the direction of motor rotation is incorrect, exchange the connections of terminals O1 and O2.

⚠ ⚠ Never connect more than one motor per control unit!

3.4 - Power supply

The electric power supply of the control unit must be connected by means of terminals L and N (Live, Neutral). The BiDi-Shutter control unit can operate with supply voltage of 100 to 240 Volts and frequency of 50 or 60 Hz.

3.5 - Pushbuttons

If required, external, momentary pushbuttons can be connected to terminals S1 and S2, which can control the unit directly. The pushbuttons are connected between neutral (N) and terminals S1 and S2 as shown in figure 2. The pushbutton connected to S1 is responsible for Up movement, and the pushbutton connected to S2 is responsible for Down movement.

⚠ ⚠ The pushbuttons carry mains voltage and must therefore be adequately protected and insulated.

4 MEMORISING TRANSMITTERS

- This chapter describes the memorisation procedures in Mode I, used to control a single automation with the 3 keys of the transmitters and Mode II, used to control an automation with a single key, thus leaving the other keys free for control of other automations.
- The key ■ corresponds to the central key of the transmitters ERGO, PLANO and NICEWAY.
- All memorisation sequences are timed, which means they must be completed within the set time limits.
- With transmitters that envisage several “groups”, the relative group to associate with the control unit must be selected before proceeding.
- Settings via radio are possible on all receivers located within the operating radius of the transmitter, and therefore only the device required for the operation should remain powered.

4.1 - Mode I





In Mode I the command associated with the transmitter keys is fixed (table A1). In Mode I only one memorisation phase is performed for each transmitter and only one memory location is occupied. During memorisation in Mode I it is not important which key is pressed on the transmitter.

Table A1 - Memorisation using Mode I

Key	Command
Key ▲ or 1st channel	Up
Key ■ or 2nd channel	Stop
Key ▼ or 3rd channel	Down





4.2 - Memorising transmitters in Mode I

When there is no transmitter memorised, the first can be memorised during startup according to the following procedure.





Table A2 - Memorising first transmitter during startup in Mode I		Example
01.	Connect the control unit to the power mains, confirmed by 2 red flashes.	
02.	Within 10 seconds: <ul style="list-style-type: none"> • Monodirectional transmitters: press and hold any key of the transmitter to be memorized for at least 3 seconds. • Bidirectional transmitters: press any key of the transmitter to be memorized 	MONO:  BIDI: 
03.	If the memorisation procedure is successful, the LED emits 3 red flashes.	

If no transmitters should be memorized during startup, the programming procedure concludes automatically after 10 seconds and the LED emits one long red flash.

The transmitters can be memorised using the programming pushbutton according to the following procedure.

Table A3 - Memorising first and other transmitters in Mode I		Example
01.	Press and hold the programming pushbutton (fig. 1).	
02.	Release the programming pushbutton (fig. 1) when the LED illuminates with red color (1st position).	
03.	Within 10 seconds: <ul style="list-style-type: none"> • Monodirectional transmitters: press and hold any key of the transmitter to be memorized for at least 3 seconds. • Bidirectional transmitters: press any key of the transmitter to be memorized 	MONO:  BIDI: 
04.	If the memorisation procedure is successful, the LED emits 3 red flashes.	
05.	Repeat steps 3 and 4 to acquire all the remotes.	
06.	After 10 seconds that the device doesn't receive any signal, the programming procedure concludes automatically.	

If transmitters have already been memorised, other transmitters can be memorised as described in the following procedure.

Table A4 - Memorising other transmitters with a previously memorised transmitter in Mode I		Example
01.	Press any key three times of a previous , memorised transmitter.	Old  x3
02.	Press the same key three times of a new transmitter.	New  x3
03.	Press the same key three times of a previous , memorised transmitter.	Old  x3
04.	Press the same key of the new transmitter.	New 
05.	If the memorisation procedure is successful, the LED emits 3 red flashes.	
06.	The programming procedure concludes automatically.	

Note. If the memory is full (30 transmitters memorised) 6 red flashes are emitted and the transmitter cannot be memorised.

4.3 - Mode II

In Mode II each key of the transmitter can be associated with one of 10 possible commands (table A5); for example, one automation can be controlled with just one key memorised for the Step-by-step command, while the other keys are left free for control of other automations. In Mode II one memorisation phase is performed for each key and each occupies one location in the memory. During Mode II memorisation, the specific key pressed is memorised. If another key is to be assigned a command on the same transmitter, a new memorisation phase must be performed for that specific key.

Warning! - For the partial positions to work correctly, you must perform the calibration procedure (see chapter 5.1).

Table A5 - Memorisation using Mode II	
N°	Command
1	Step-by-step (Up-Stop-Down-Stop...)
2	Go to position level 5%
3	Go to position level 25%
4	Go to position level 50%
5	Go to position level 75%
6	Up
7	Down
8	Stop
9	“Hold-to-run” Down*
10	“Hold-to-run” Up*

* “Hold-to-run” command is not be available in some transmitters.

4.4 - Memorising transmitters in Mode II

Table A6 - Memorising first and other transmitters in Mode II		Example
01.	Press and hold the programming pushbutton (fig. 1).	
02.	Release the programming pushbutton (fig. 1) when the LED illuminates with orange color (2nd position).	
03.	Press the programming pushbutton (fig. 1) the number of times corresponding to the required command (1 = Step-by-Step, 2 = go to position level 5%, 3 = go to position level 25%, 4 = go to position level 50%, 5 = go to position level 75%, 6 = Up, 7 = Down, 8 = Stop, 9 = Hold-to-run Down, 10 = Hold-to-run Up).	1-10
04.	Check that the LED emits the number of long orange flashes corresponding to the required command.	1-10
05.	Within 10 seconds: <ul style="list-style-type: none"> Monodirectional transmitters: press and hold the required key of the transmitter to be memorized for at least 3 seconds. Bidirectional transmitters: press the required key of the transmitter to be memorized 	MONO: BIDI:
06.	If the memorisation procedure is successful, the LED emits 3 orange flashes.	
07.	Repeat steps 5 and 6 to acquire all the remotes with the same command.	
08.	Repeat steps 3 to 6 to acquire all the remotes with another command.	
09.	After 10 seconds that the device doesn't receive any signal, the programming procedure concludes automatically.	

Note. If the memory is full (30 transmitters memorised) 6 orange flashes are emitted and the transmitter cannot be memorised.

4.5 - Memorising a new transmitter using the “enabling code” of an already memorised transmitter

The bidirectional transmitter has a secret code, the so-called “enabling code”. By transferring this code from a memorized transmitter to a new transmitter, the latter is recognized (and memorized) automatically by the control unit. Please refer to the manual of the transmitters for further details.

Warning! - The enabling code can only be transferred between two transmitters that have the same radio coding.

Table A7 - Transmitting the “enabling code”		Example
01.	Bring a previous , memorised transmitter and the new transmitter close to one another.	
02.	On the new transmitter press command key. The LED of the previous transmitter will switch on and start flashing.	New Old
03.	On the previous transmitter press command key.	Old
04.	Once the code has been transferred, for an instant both the transmitters will vibrate and the green LED will light up signalling end of the procedure. When the new transmitter will be used, for the first 20 times it will transmit this “enabling code” to the receiver together with the command. The receiver will automatically memorize the identification code of the transmitter that transmitted it	



5.1 - Calibration

During calibration process the device learns the position of the Up and Down limit positions. The calibration can be performed automatically or manually. During the automatic calibration the motor will perform Up, Down and Up again manoeuvres to recognize the limit positions. During the manual calibration limit positions must be saved manually while the motor performs Up/Down manoeuvres.







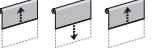

⚠ If the automatic calibration was not able to properly recognize the limit positions, perform the manual calibration instead. The control unit will calibrate itself after the user performs two full manoeuvres (Up to Down and Down to Up), but performing the calibration according to one of the procedures below is recommended before operation.

Before the calibration, set the shutter to the middle position.

To perform automatic calibration, proceed as described below.

Table A8 - Automatic calibration		Example
01.	Press and hold the programming pushbutton (fig. 1).	
02.	Release the programming pushbutton (fig. 1) when the LED illuminates with blue color (3rd position).	
03.	Press key ■ (or second channel) of the transmitter.	
04.	The motor will complete Up, Down and Up again maneuvers automatically.	
05.	The programming procedure concludes automatically upon finishing 2 complete maneuvers.	

To perform calibration manually, proceed as described below. Perform manual calibration only when automatic doesn't work.

Table A9 - Manual calibration		Example
01.	Press and hold the programming pushbutton (fig. 1).	
02.	Release the programming pushbutton (fig. 1) when the LED illuminates with blue color (3rd position).	
03.	Press key ▲ (or first channel) of the transmitter to start calibration.	
04.	Device will start Up maneuver.	
05.	Press key ■ (or second channel) of the transmitter to set Up limit position.	
06.	Device will start Down maneuver.	
07.	Press key ■ (or second channel) of the transmitter to set Down limit position.	
08.	Device will start Up maneuver.	
09.	Press key ■ (or second channel) of the transmitter to set Up limit position.	
10.	The programming procedure concludes automatically	





5.2 - Partial positions

The BiDi-Shutter control unit enables setting a quickly accessible partial positions. Partial positions work only with transmitters memorized in Mode I.





Table A11 - Available partial positions		
N°	Press at the same time to activate	Default position
1	▲ and ▼ 1st and 3rd channel S1 and S2	50% of the working time
2	▲ and ■ 1st and 2nd channel	15% of the working time

- ⚠**
- If the Venetian blinds mode is enabled (see chapter 5.5), by default (2nd partial position), the blinds stop at 15% and slats are rotated to 10%.
 - If the Venetian blinds mode is disabled, by default (2nd partial position), the shutter stops at 15%.
 - In order for the partial positions to work, the calibration must be performed.
 - Pressing S1 and S2 at the same time might not be possible for some types of pushbuttons/switches.

To set new position for 1st partial position, proceed as described below.



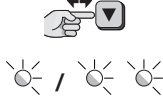

Table A12 - Setting 1st partial position		Example
01.	Press and hold the programming pushbutton (fig. 1).	
02.	Release the programming pushbutton (fig. 1) when the LED illuminates with white color (5th position).	
03.	Press ▲ and ▼ or 1st and 3rd channel at the same, the LED will confirm with one white flash.	
04.	Bring the shutter/blind/awning at your desired partial position (or press ▲ and ▼ or 1st and 3rd channel at the same time to disable the 1st partial position altogether).	
05.	Save and conclude the programming by pushing the programming pushbutton (fig. 1).	

To set new position for 2nd partial position, proceed as described below.

Table A13 - Setting 2nd partial position		Example
01.	Press and hold the programming pushbutton (fig. 1).	
02.	Release the programming pushbutton (fig. 1) when the LED illuminates with white color (5th position).	
03.	Press ▲ and ■ or 1st and 2nd channel at the same, the LED will confirm with two white flashes.	
04.	Bring the shutter/blind/awning at your desired partial position (or press ▲ and ■ or 1st and 2nd channel at the same time to disable the 2nd partial position altogether).	
05.	Save and conclude the programming by pushing the programming pushbutton (fig. 1).	

5.3 - Virtual Limit Switch

If needed, it is also possible to set a virtual limit switch, limiting the shutter/blind/awning movement to the specified position (range).

Table A14 - Setting a virtual limit switch		Example
01.	Bring the shutter/blind/awning at your desired position (virtual limit switch).	
02.	Press and hold the programming pushbutton.	
03.	Release the programming pushbutton when the LED illuminates with blue color (3rd position).	
04.	Press key ▼ (or third channel) of the transmitter: <ul style="list-style-type: none"> If the LED will confirm with one blue flash, the procedure is active, If the LED will two blue flashes, the procedure is canceled because the roller shutter wasn't calibrated before. 	
05.	Press the key of the transmitter to select mechanical limit switch: <ul style="list-style-type: none"> ▲ or first channel - the top limit switch, ▼ or third channel - the bottom limit switch. 	
06.	The motor will make a move between the virtual and mechanical limit switch.	
07.	The programming procedure concludes automatically.	

5.4 - Wired pushbutton programming

The pushbuttons connected to the S1 (Up) and S2 (Down) inputs can be programmed in different ways:





- **Go to the limit position** – after pressing the pushbutton the motor goes to the programmed limit switch,
- **Hold to run** – the pushbutton must be pressed and held for the motor to move, then released to stop the motor at the desired position.

In case of the wired pushbuttons programmed as “Go to the limit position”, it is possible to choose how the motor can be stopped:

- Pressing both pushbuttons together,
- Pressing the pushbutton for the same direction that the shutter goes,
- Pressing the pushbutton for the opposite direction that the shutter goes.

By default, the motor is stopped when pushbutton for the opposite direction is pressed.

To select the stopping action, proceed as described below.



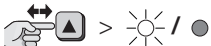

Table A15 - Setting wired pushbutton		Example
01.	Press and hold the programming pushbutton (fig. 1).	
02.	Release the programming pushbutton (fig. 1) when the LED illuminates with violet color (6th position).	
03.	Press the pushbutton the number of times corresponding to the required command (1 = press both push-buttons together to stop the motor*, 2 = press the pushbutton for the same direction to stop the motor, 3 = press the pushbutton for the opposite direction to stop the motor, 4 = pushbuttons work as Hold to run).	1-4 
04.	Check that the LED emits the number of violet flashes corresponding to the required command.	1-4 
05.	The programming procedure concludes automatically.	

* If the 1st partial position is already programmed, the S1 and S2 keys together action cannot be used for stopping. Pressing S1 and S2 at the same time might not be possible for some types of pushbuttons/switches.

5.5 - Venetian blinds

The BiDi-Shutter control unit enables the control of slats for Venetian blinds. When the Venetian blinds control is enabled, pressing ▲/S1 or ▼/S2 will move the slats by 20% and the normal Up and Down maneuvers must be performed by pressing and holding the corresponding keys. For the function to work properly, time of full slats movement must be adjusted. By default, the Venetian blinds function is disabled and full movement time is set to 1.5s.



To enable or disable the Venetian blinds control and set the slats movement time, proceed as described below.

Table A16 - Setting Venetian blinds behavior		Example
01.	Press and hold the programming pushbutton (fig. 1).	
02.	Release the programming pushbutton (fig. 1) when the LED illuminates with cyan color (7th position).	
03.	Press key ▲ (or first channel) of the transmitter toggle the setting, the LED informs about current setting: <ul style="list-style-type: none"> Fixed cyan – Venetian blinds control enabled Turned off – Venetian blinds control disabled 	
04.	Press the pushbutton the number of times corresponding to the required time (1 = 250ms, 2 = 500ms, 3 = 750ms, 4 = 1s, 5 = 1.25s, 6 = 1.5s, 7 = 1.75s, 8 = 2s, 9 = 2.25s, 10 = 2.5s, 11 = 2.75s, 12 = 3s).	1-12 
05.	Check that the LED emits the number of cyan flashes corresponding to the required time.	1-12 
06.	After 10 seconds that the device doesn't receive any signal, the programming procedure concludes automatically.	

5.6 - Climatic sensors

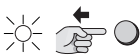

The control unit supports Nice radio mono and bidirectional climatic sensors. Memorisation of a climatic sensor must be carried out like that of a normal transmitter (follow procedure in table A3). Thresholds for commands must be programmed on the climatic sensor. Commands connected to Wind are given priority, followed by the sun and rain. Reactions to sun/rain can be turned on/off using the button Sun ON/OFF (by default the reactions are turned on). Please refer to the manual of the climatic sensor for further details.

Table A17 - Response to climatic commands	
Command	Response
Sun ON	Go to Down position
Sun OFF	Go to Up position
Rain ON	Go to Down position
Rain OFF	Go to Up position
Wind ON	Go to Up position (can be changed according to table A17) or Go to Down position or Motor blocked if Venetian blinds control enabled
Wind OFF	Unblock the motor control

Table A18 - Setting response to Wind ON command		Example
01.	Press and hold the programming pushbutton (fig. 1).	
02.	Release the programming pushbutton (fig. 1) when the LED illuminates with green color (4th position).	
04.	Press key of the transmitter to select response to Wind ON command: <ul style="list-style-type: none"> ▼ (or third channel) – go to Down position ▲ (or first channel) – go to Up position (default) 	
05.	Currently set response to Wind ON command will be confirmed with LED flashes: <ul style="list-style-type: none"> LED emits 2 green flashes - go to Down position LED emits 4 green flashes - go to Up position 	2/4 
06.	After 10 seconds, if the device doesn't receive any signal, the programming procedure concludes automatically.	

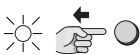

5.7 - Deleting transmitters

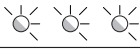
If memorised transmitters and settings need to be deleted, proceed as described below.

Table A19 - Deleting transmitter from memory		Example
01.	Press and hold the programming pushbutton (fig. 1).	
02.	Release the programming pushbutton (fig. 1) when the LED illuminates with yellow color (8th position).	
03.	Press any key on the acquired transmitter to remove it from memory.	
04.	LED emits 3 yellow flashes to confirm the correct removal.	
05.	After 10 seconds that the device doesn't receive any signal, the programming procedure concludes automatically.	

5.8 - Factory reset

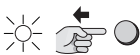
If the control unit needs to be reset to the factory settings (all transmitters and setting will be deleted), proceed as described below.

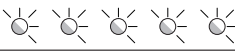
Table A20 - Restoring to factory defaults		Example
01.	Press and hold the programming pushbutton (fig. 1).	
02.	Release the programming pushbutton (fig. 1) when the LED illuminates with yellow color (8th position).	
03.	Press the programming pushbutton (fig. 1).	
04.	LED emits 5 yellow flashes to confirm the correct reset.	
05.	The programming procedure concludes automatically. Afterwards the control unit will initiate the start-up procedure according to table A2.	

6 LED SIGNALS

6.1 - Programming menu

When pressing and holding the programming pushbutton on the control unit, the LED will signal consecutive positions of the programming menu.

Table A21 - menu positions when holding the programming pushbutton		
N°	Color	Description
1	Red	Memorization in Mode I
2	Orange	Memorization in Mode II
3	Blue	Calibration
4	Green	Response to Wind ON command (see Table A18)
5	White	Partial position settings
6	Violet	Stopping with pushbuttons settings
7	Cyan	Venetian blinds mode settings
8	Yellow	Reset

6.2 - Other signals

Table A22 - other LED signals	
Color	Description
2 red flashes	Control unit initialized properly
3 red flashes	Transmitter memorized in Mode I
3 orange flashes	Transmitter memorized in Mode II
6 red flashes	Memory for transmitters full (Mode I)
6 orange flashes	Memory for transmitters full (Mode II)
3 yellow flashes	Transmitter deleted from memory
5 yellow flashes	Control unit restored to factory settings

7 TECHNICAL SPECIFICATIONS

The product BiDi-Shutter is produced by Nice S.p.A. (TV). Warnings: - All technical specifications stated in this section refer to an ambient temperature of 20 °C (± 5 °C) - Nice S.p.A. reserves the right to apply modifications to the product at any time when deemed necessary, while maintaining the same functionalities and intended use.

BiDi-Shutter	
Type	in-wall/flush box mounted control unit for tubular motors
Power supply	100–240 V AC, 50/60 Hz
Motor rated current	2 A
Motor rated power	480 VA for Vn = 240 V; 460 VA for Vn = 230 V; 240 VA for Vn = 120 V; 200 VA for Vn = 100 V
Recommended wires cross-section	0.5–4 mm ² for 1 wire; 0.5–1.5 mm ² for 2 wires
Required circuit breaker	Compliant with IEC/EN 60898-1; Curve code: B; Rated current: up to 16 A; Breaking capacity: 6 kA; Rated insulation voltage: 500 V; Rated impulse withstand voltage: 4 kV;
Casing protection rating	IP 20
Operating temperature	0–35 °C
Dimensions (mm)	45 x 36 x h 23
Weight	20 g

Radio transceiver	
Frequency band	433.05–434.04 MHz
Code	OPERA/FLOR (rolling code), PLN2+ (rolling code)
No. of memorisable transmitters	30, including climatic sensors
Transceiver range	Estimated at 150 m in open space and 20 m inside buildings (*)
Max. transmit power	10 dBm

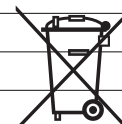

(*) The transceiver range is strongly influenced by other devices operating at the same frequency with continuous transmission, such as alarms and radio headphones which interfere with the control unit transceiver.

8 PRODUCT DISPOSAL

This product is an integral part of the automation and therefore must be disposed together with the latter.

As in installation, also at the end of product lifetime, the disassembly and scrapping operations must be performed by qualified personnel. This product is made of various types of material, some of which can be recycled while others must be scrapped. Seek information on the recycling and disposal systems envisaged by the local regulations in your area for this product category.

Caution! – some parts of the product may contain pollutant or hazardous substances which, if disposed of into the environment, may cause serious damage to the environment or physical health.

As indicated by the symbol alongside, disposal of this product in domestic waste is strictly prohibited. Separate the waste into categories for disposal, according to the methods envisaged by current legislation in your area, or return the product to the retailer when purchasing a new version.

Caution! – local legislation may envisage serious fines in the event of abusive disposal of this product.

9 DECLARATION OF CONFORMITY

Hereby, Nice S.p.A., declares that the radio equipment type BiDi-Shutter is in compliance with Directive 2014/53/EU.

The full text of the EU declaration of conformity is available at the following internet address: <http://www.niceforyou.com/en/support>



Nice SpA
Oderzo TV Italia
info@niceforyou.com

www.niceforyou.com