

Industrial

CE

D-PRO AUTOMATIC

- NDCC1000
- NDCC1100
- NDCC1200

EN

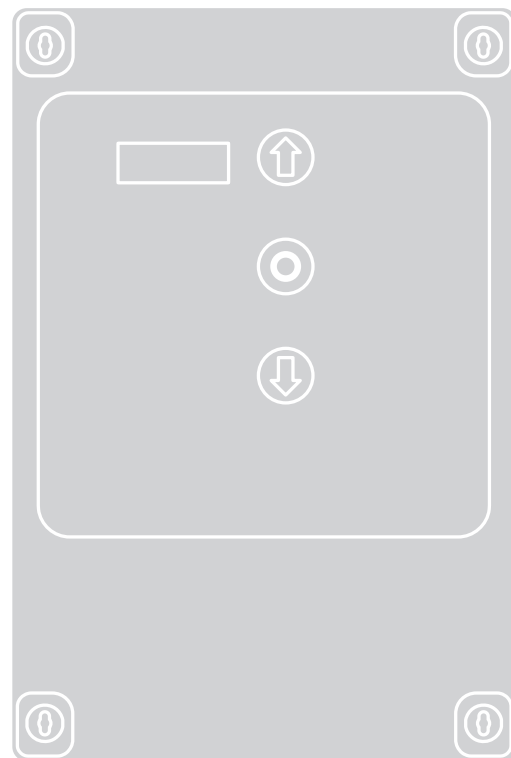

Control unit

EN - Installation instructions and warnings

Nice

Translation of the original instructions in English

Translation of the original installation instructions in full.

GENERAL SAFETY INSTRUCTIONS	4	4. TESTING AND PUTTING INTO SERVICE	18
Work safely!.....	4	4.1 Testing.....	18
Special warnings in relation to European Directives.....	5	4.2 Putting into service	18
1. PRODUCT DESCRIPTION AND INTENDED USE	6	4.3 Setting a PIN (control unit lockout code)	18
2. PRODUCT INSTALLATION	6	4.3.1. <i>Setting the PIN (control unit lockout code)</i>	18
2.1 Installation criteria and special warnings in relation to essential requirements	6	4.3.2. <i>Unlocking the control unit (momentary)</i>	19
2.2 Pre-installation checks	6	4.3.3. <i>Deactivating the PIN (control unit lockout code)</i>	19
2.3 Product use limitations	6	5. LIST OF PARAMETERS AND ERRORS.....	20
2.4 Typical installation	7	5.1 Service parameter table - "P" series	20
2.5 Control unit installation.....	8	5.1.1. <i>Automatic door cycles – P4</i>	25
2.6 Description of electronic circuit board	10	5.1.2. <i>Overrun correction via brake activation P20-P22</i>	25
2.7 Description of push button panel board	11	5.1.3. <i>Maximum permissible deviation from set limit switches P14</i>	25
3. ELECTRICAL CONNECTIONS.....	12	5.1.4. <i>Automatic ground adaptation P30-P33</i>	25
3.1 Three-phase power cable connection for NDCC1000 control units.....	12	5.1.5. <i>Power transmission for wireless safety edges</i> <i>P88-P89 and P100-P112</i>	25
3.2 Single-phase power cable connection for NDCC1100 and NDCC1200 control units.....	12	5.1.6. <i>Air curtain – P45 and P110-P112</i>	25
3.3 Electrical connections for the safety edge	12	5.1.7. <i>Brake management for inverters without identification label</i> <i>P50-P54 e P57-P58</i>	25
3.3.1. <i>Connecting an optical safety edge</i>	12	5.1.8. <i>Alternative display – P5</i>	25
3.3.2. <i>Connecting a resistive or pneumatic safety edge</i>	12	5.2 Inverter setting parameter table – "U" series	26
3.4 Electrical connections for photocells	13	5.3 Service parameter table - "C" series	27
3.5 Electrical connections for external buttons (INPUT)	13	5.4 D-Pro Automatic errors list.....	28
3.6 Electrical connections for signal lights (OUTPUT)	13	5.5 Nice inverter errors list	29
3.7 Control unit electrical connections	13	6. DISPOSING OF THE PRODUCT	30
3.8 Connection of a radio receiver	14	7. PRODUCT SPECIFICATIONS	30
3.9 Initial switch-on and checking connections	14	8. DECLARATION OF PRODUCT CONFORMITY.....	31
3.10 Resetting door cycles - "Service" error.....	14		
3.11 Deleting the control unit memory	14		
3.12 Position learning	15		
3.12.1. <i>Position fine adjustment</i>	16		
3.12.2. <i>Setting opening and closing positions with</i> <i>MECHANICAL LIMIT SWITCH</i>	16		
3.13 Changing direction of motor rotation.....	17		
3.14 Enabling partial opening.....	17		

The design and construction of the devices contained in the D-PRO Automatic door control units, as well as the information given in these use instructions, comply with the applicable safety regulations. Incorrect installation can result in serious injury to persons carrying out the work or using the system. For this reason, it is important to comply fully with these instructions during installation.

Do not continue with the installation if you have any doubts whatsoever and, if necessary, request Nice customer service support.

Throughout this manual, the term "product" refers to the D-PRO Automatic control unit mod. NDCC1000 mod. NDCC1100, mod. NDCC1200. Unless specified otherwise, the instructions apply to all models.

WORK SAFELY!

WARNING! – Important safety instructions. Failure to comply with safety regulations or any installation, use or maintenance other than those indicated in this booklet:

- Invalidates the warranty
- Can cause damage, injury or fatal accidents
- Relieves the Manufacturer from any liability.

WARNING! – Unauthorised work, tampering or modifications not in accordance with this manual may result in damage, injury or fatal accidents and will invalidate the warranty.

WARNING! – Store this manual carefully for future reference.

WARNING! – Before performing any operation or procedure, carefully read the general safety instructions given in this manual and sect. "[2.3 Product use limitations](#)" on p. [6](#).

These instructions must be followed:

- Before starting the installation, check the technical specifications of the product (see chap. "[7. PRODUCT SPECIFICATIONS](#)" on p. [30](#)), in particular whether this product is suitable for automating your guided part. If it is not suitable, DO NOT proceed with the installation
- The product may not be used until it has been put into service (see chap. "[4. TESTING AND PUTTING INTO SERVICE](#)" on p. [30](#)).
- **During installation and maintenance operations, use the personal protective equipment (PPE) required by the safety regu-**

lations in force in the country where the product is installed (e.g. protective gloves).
WARNING! – According to the most recent European legislation, the installation of an automation must comply with the harmonised standards set out in the current Machinery Regulation, which enable the conformity of the automation to be declared.

In view of this, all connection to the mains, testing and putting into service, and maintenance work must be carried out solely by a competent, qualified technician!

- Before proceeding with product installation, check that all the material to be used is in excellent condition and suitable for use
- The product is not intended for use by persons (including children) with reduced physical, sensory or mental capabilities, or lack of experience or knowledge
- Children must not play with the product
- Do not allow children to play with the product control devices. Keep remote controls away from children

WARNING! – To avoid any risk arising from accidentally rearming the thermal cut-off device, this product must not be powered by an external manoeuvre device, such as a timer, or be connected to a circuit that is regularly energized or de-energized.

- Provide a disconnection device (not supplied) in the system's power supply network with a contact opening distance that allows complete disconnection under the conditions dictated by overvoltage category III
- During the installation, handle the product carefully, avoiding crushing, knocks, falls or contact with liquids of any kind. Do not put the product near sources of heat or expose it to open flames. All these actions can damage it and cause malfunctions or dangerous situations. If this happens, stop the installation immediately and contact the Support Service
- The manufacturer accepts no liability for damage to property or persons resulting from failure to follow the assembly instructions. Warranty for material defects is excluded in these cases
- The sound pressure level of the A-weighted emission is less than 70 dB(A)
- Cleaning and maintenance intended to be carried out by the user must not be carried out by unsupervised children

- Always disconnect the product from the power supply before working on the system (maintenance, cleaning)
- Check the system frequently, in particular check cables, springs and supports for any imbalance and signs of wear or damage. Do not use if repair or adjustment is required, as incorrect installation or balancing of the automation can lead to injury
- The product packaging must be disposed of in compliance with local regulations. The packaging material is recyclable cardboard (PAP 20 marking). Do not leave packaging unattended, within reach of children or animals.

SPECIAL WARNINGS IN RELATION TO EUROPEAN DIRECTIVES APPLICABLE TO THE PRODUCT

• **Low Voltage Directive:**

- Special warnings on the suitability for use of this product in relation to the “Low Voltage” Directive. This product meets the requirements of the “Low Voltage” Directive when used as intended and in the configurations provided in this instruction manual and in combination with the items in the Nice S.p.a. product catalogue.
- The requirements may not be guaranteed if the product is used in unintended configurations or with other unintended products; it is forbidden to use the product in these situations until the person carrying out the installation has verified compliance with the requirements of the directive.

• **Electromagnetic Compatibility Directive:**

- Special warnings on the suitability for use of this product in relation to the “Electromagnetic Compatibility” Directive.
- This product has been tested for electromagnetic compatibility in the most critical usage situations, in the configurations foreseen in this instruction manual and in combination with the items in the Nice S.p.a. product catalogue.
- Electromagnetic compatibility may not be guaranteed if the product is used in unintended configurations or with other unintended products; it is forbidden to use the product in these situations until the person carrying out the installation has verified compliance with the requirements of the directive.

1. PRODUCT DESCRIPTION AND INTENDED USE

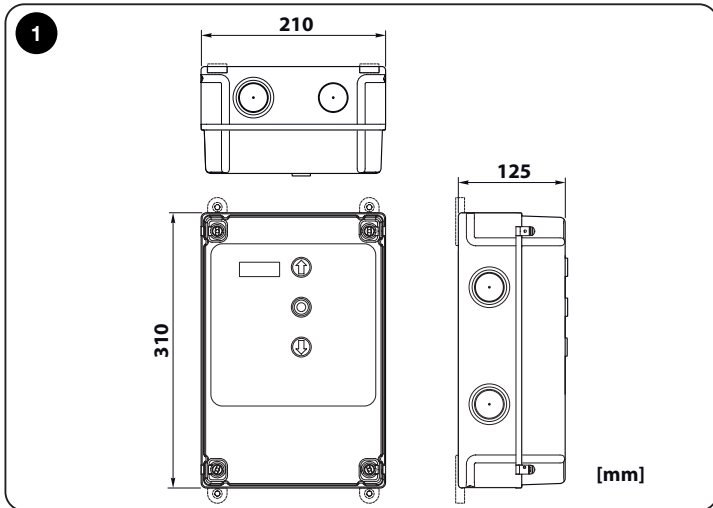

- **NDCC1000** is a control unit designed to operate **rolling shutters** and **sectional doors** with **three-phase 3x400 Vac motors** equipped with Nice **encoders** or **mechanical limit switches**.
- **NDCC1100** is a control unit designed to operate **high speed doors** with **HDFI single-phase motor with inverter** equipped with Nice **encoders**.
- **NDCC1200** is a control unit designed to operate **sectional doors** with **single-phase 1x230 Vac motors** equipped with Nice **encoders** or **mechanical limit switches**.

TABLE 1 - Types of connection motor

Model	Type of door	Connection	Max. power
NDCC1000	Rolling shutters and sectional doors	Three-phase motors with and without brake	2.2kW
NDCC1100	High speed doors	Motors with inverter and brake	2.2kW
NDCC1200	Sectional doors	Single-phase motors with start and run capacitors	2.2kW

All control unit models can be connected to any common safety device.

To open and close a door, simply use the:

- specific button installed on the cover;
- external button;
- radio receiver.

WARNING! – Any use other than that described in this chapter and under environmental conditions other than those specified in this manual is to be considered improper and prohibited!

2. PRODUCT INSTALLATION

2.1 Installation criteria and special warnings in relation to essential requirements

Carry out the installation while carefully following all the instructions described in chap. "[2. PRODUCT INSTALLATION](#)" on p. [6](#) and in chap. "[4. TESTING AND PUTTING INTO SERVICE](#)" on p. [18](#).

Ensure that an adequate maintenance plan is put in place (see "[4.2 Putting into service](#)" on p. [18](#)).

2.2 Pre-installation checks

Before installation, check the integrity of the control unit components, the suitability of the chosen model and the suitability of the installation site:

- Check that all the material to be used is in excellent condition and suitable for the intended use.
- Check that all conditions of use are within the product's use limitations (see "[2.3 Product use limitations](#)") and within the limits of the values given in chap. "[7. PRODUCT SPECIFICATIONS](#)" on p. [30](#).
- Check that the chosen installation site is compatible with the overall dimensions of the product (fig. [1](#)).
- Ensure that the surface chosen for installing the product is solid and can guarantee stable installation.
- Check that the fastening area is not subject to flooding; if necessary, install the product adequately raised off the ground.
- Check that the space around the product allows easy and safe access.
- Check that all electrical cables to be used are of the type listed in "[TABLE 3 - Electrical cable specifications](#)".

2.3 Product use limitations

The product may only be used as stated in "[TABLE 2 - Use limitations](#)".

WARNING! – The control units described in this instruction manual may NOT be used in areas at risk of explosion.

TABLE 2 - Use limitations

Model	Central power supply	Type of motor (*)
NDCC1000	Three-phase 3x400 Vac 50/60Hz	Three-phase 3x400 Vac 50/60Hz with Nice encoder or mechanical limit switches
NDCC1100	Single-phase 1x230 Vac 50/60Hz	Single-phase with inverter 3x230 Vac 50/60Hz with Nice encoder
NDCC1200	Single-phase 1x230 Vac 50/60Hz	Single-phase 1x230 Vac 50/60Hz and start and run capacitors, with Nice encoder or mechanical limit switches

(*) Subject to the corresponding use limitations

2.4 Typical installation

Fig.2 shows an example of an automation system designed with Nice components:

- 1 Gearmotor
- 2 Transmitter
- 3 Safety edge
- 4 Junction box
- 5 Control unit
- 6 Spiral cable
- 7 Flashing light
- 8 Photocell
- 9 Digital keyboard - Transponder reader - Key selector switch - Push button panel

These components are positioned according to a typical and usual layout. Referring to fig. 2, determine the approximate position in which each component in the system will be installed.

IMPORTANT! – Before installation, prepare the necessary electrical cables for your system, referring to fig. 2 and "[TABLE 3 - Electrical cable specifications](#)".

WARNING! – The electrical cables used must be suitable for the particular installation site.

WARNING! – When laying pipes for the routing and entry of electrical cables into the control unit box, condensation may form inside the control unit due to possible water ingress in the inspection pits. This condensation could damage the electronic circuits.

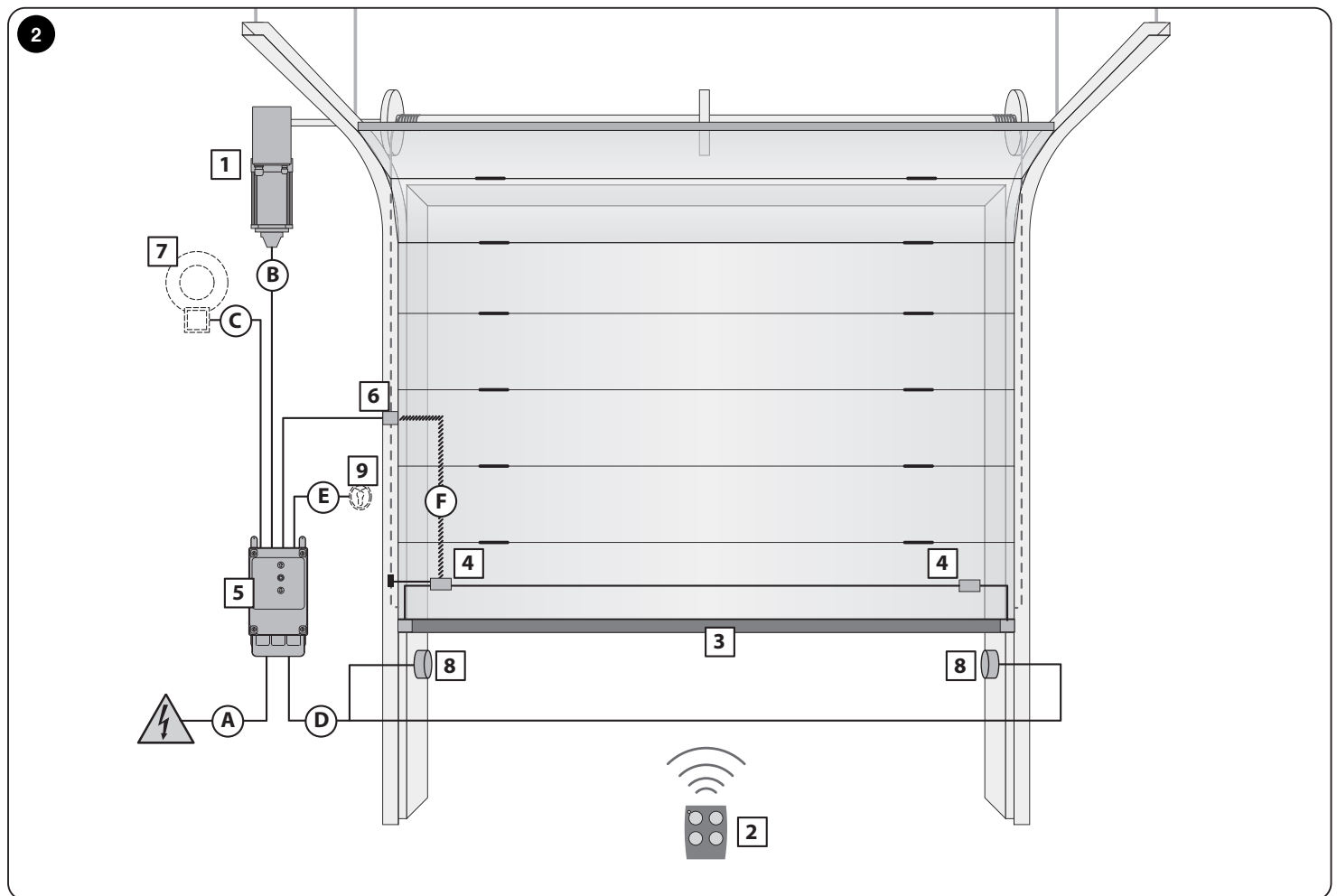

TABLE 3 - Electrical cable specifications

Connection	Type of electrical cable to be used	Maximum electrical cable length
A: MAINS cable with CEE connector	Motor < 1.5 kW = Cable 5 x 0.75 mm ² Motor > 1.5 Kw = Cable 5 x 1.5 mm ²	1 m (*)
B: MOTOR cable	Nice gearmotor cables available as optional accessories	5 - 7 - 11 m
C: FLASHING LIGHT cable	2 x 0.75 mm ²	10 m
D: PHOTOCELLS cable	4 x 0.5 mm ²	15 m
E: KEY SELECTOR SWITCH cable	3 x 2 x 0.25 mm ²	10 m
F: Spiral CABLE FOR SAFETY EDGE	Nice spiral cable available as an optional accessory	4 m

(*) When the mains cable is longer than 5 m, use a larger diameter.

2.5 Control unit installation

Proceed as follows to fasten the control unit:

01. Open the control unit cover by unscrewing its fastening screws - fig. [3A](#) or fig. [3B](#);

02. Prepare holes for the entry of electrical cables for the control and/or signalling accessories.

To maintain the IP protection rating, use a suitable tool (e.g. a hole cutter) and use the cable inlets already prepared at the bottom of the box. If necessary, the side cable inlets can be used but only if suitable pipe fittings are used.

03. Fasten the control unit using one of the 3 possible methods:

fig. [4A](#) **directly to the wall** applying the screws from inside the box;

fig. [4B](#) **using the standard supports** provided;

fig. [4C](#) **using the optional NDA100 kit**. The NDA100 kit consists of 4 spacers and a protective cover for cable inlet into the control unit box. The NDA100 kit allows the cables to be routed behind the control unit (e.g. when the cable duct is external). The NDA100 kit allows the box to be fastened at a maximum distance of 2 cm from the wall.

04. Make all the electrical connections (see chap. "[3. ELECTRICAL CONNECTIONS](#)" on p. [12](#)).

To install other devices in the automation, refer to their respective instruction manuals.

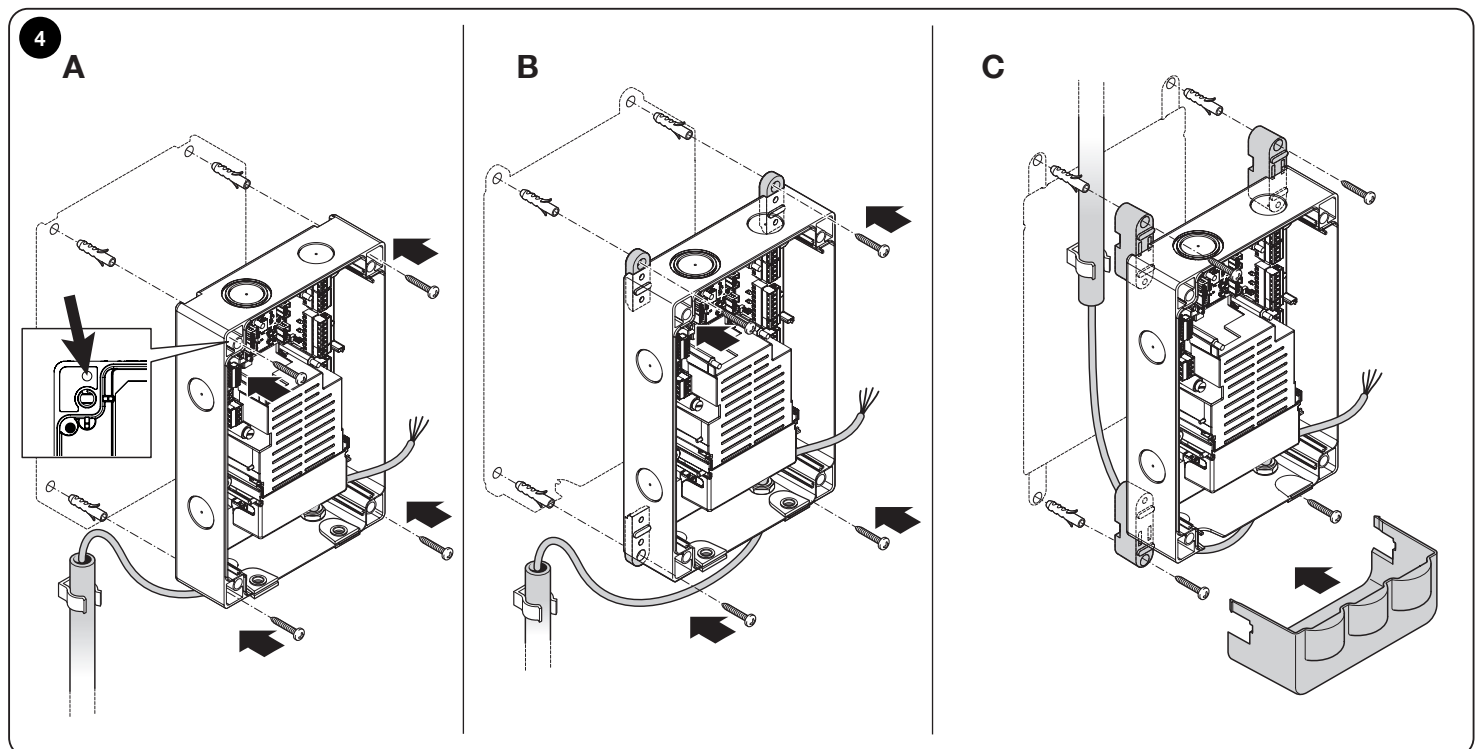
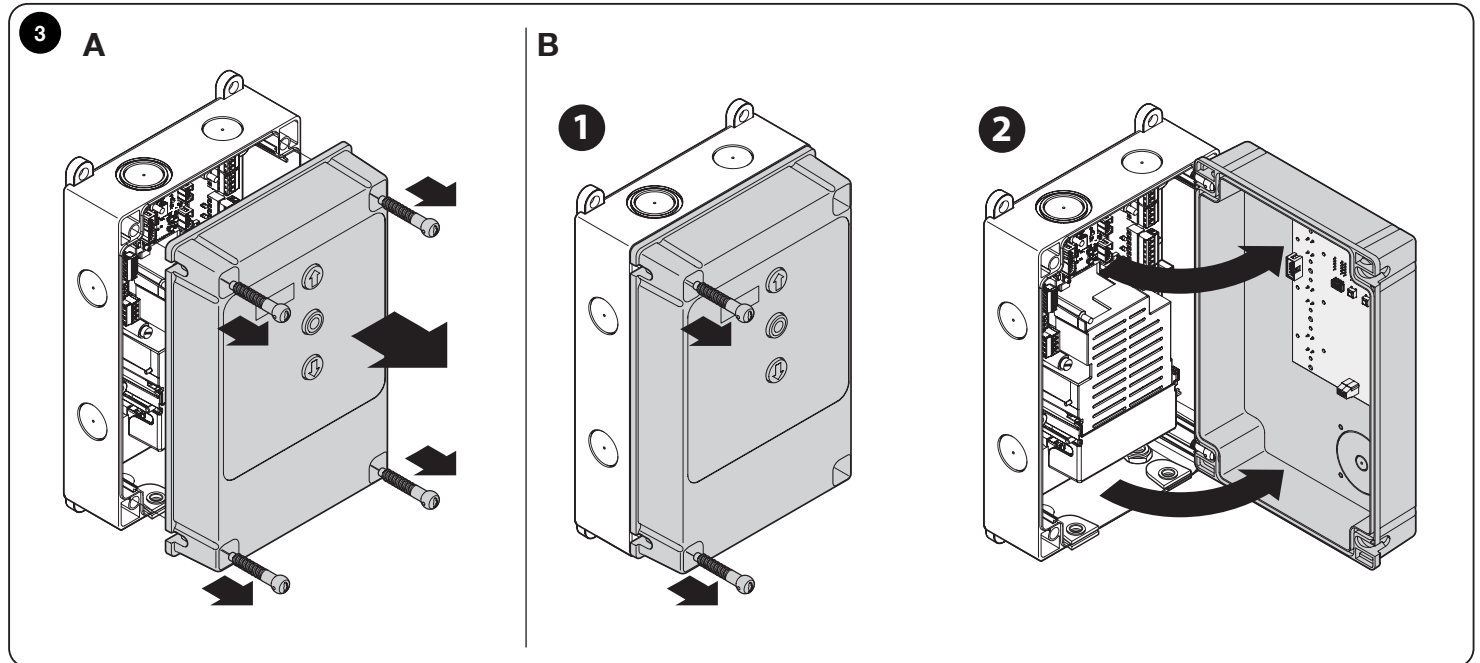

7 Three-phase motor connection (NDCC1000 control unit)

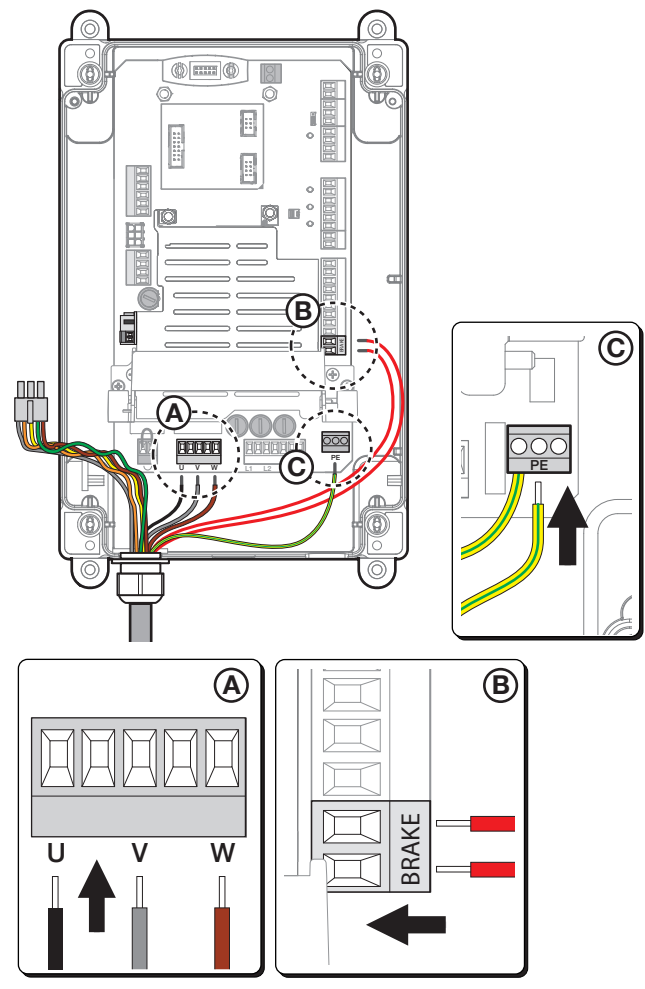

6 Connection for single-phase motor with inverter (NDCC1100 control unit)

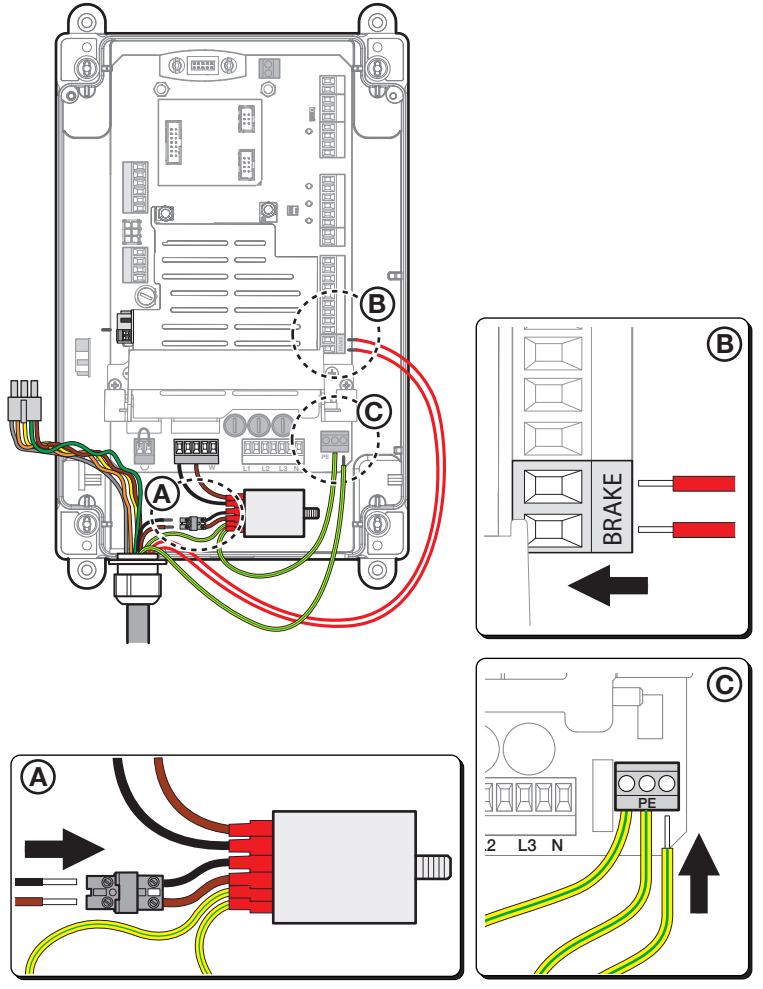

5 Connection for single-phase motor with boost board (NDCC1200 control unit)

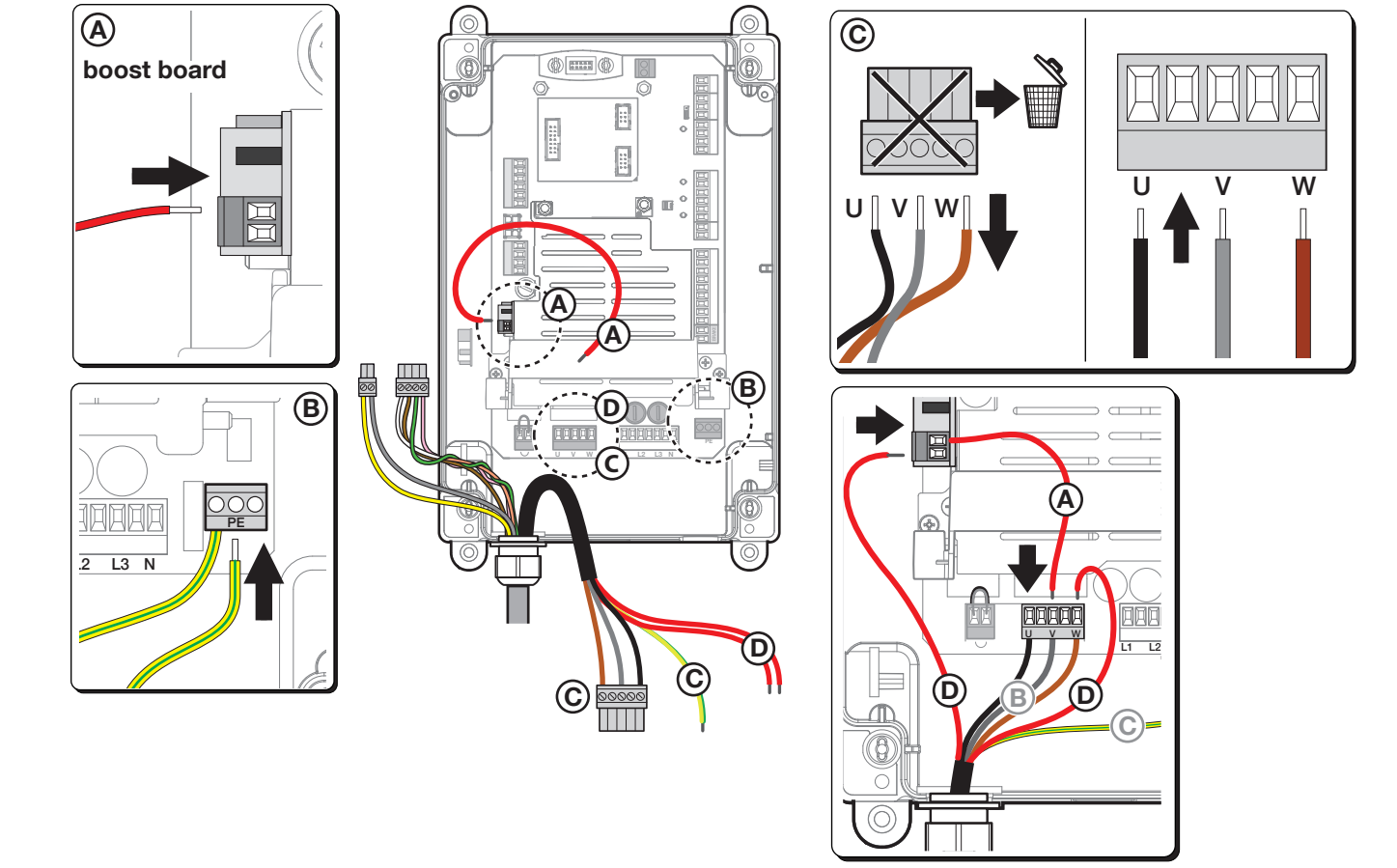

2.6 Description of electronic circuit board

8

SAFETY EDGE

Resistive/Pneumatic safety edge 8K2

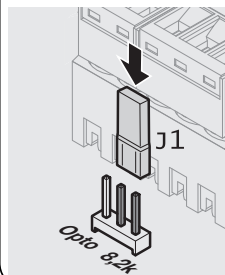

Optical safety edge (OSE)

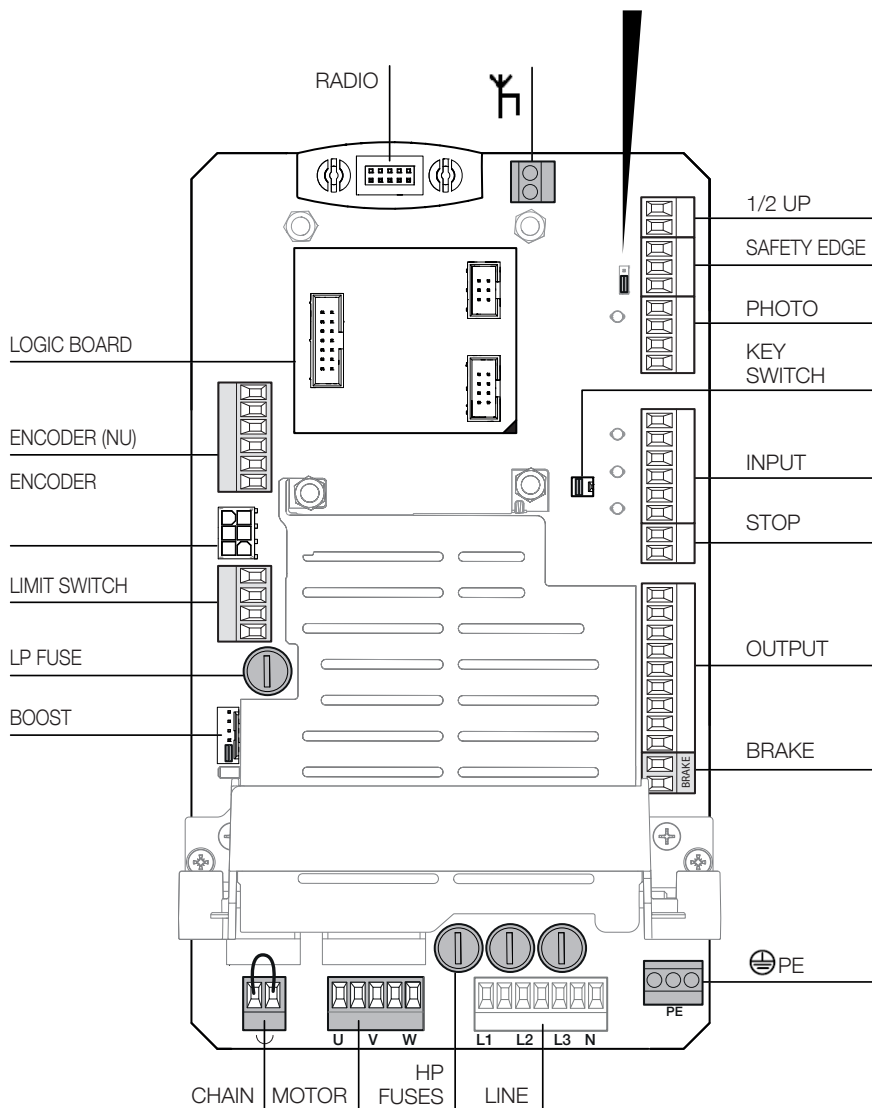
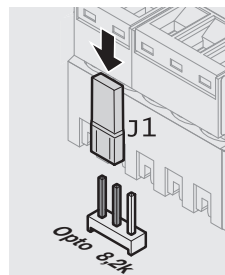

TABLE 4 - Electronic circuit board

Tag	Description
CHAIN	Removable connector for activating the chain release . If not in use, leave bridged
MOTOR	Removable connector for connecting the motor . For single-phase motors: <ul style="list-style-type: none"> • U - common • V - open • W - close
HP FUSES	T type fuses F1, F2, F3; see chap. 7. PRODUCT SPECIFICATIONS on p. 30
LINE	Removable connector for connecting the control unit to the mains (three-phase and single-phase)
PE	Terminals for earth connection
BRAKE	Removable connector for connecting a 200V DC electromechanical brake
OUTPUT	Removable connector for relay outputs: <ul style="list-style-type: none"> • Relay 1 → pins 7-8-9 (P112) • Relay 2 → pins 4-5-6 (P111) • Relay 3 → pins 1-2-3 (P110)
STOP	Removable connector for connecting an external emergency button . If not in use, leave bridged
INPUT	Removable connector for programmable inputs : <ul style="list-style-type: none"> • UP input (P100) • IMP input (P102) • DOWN input (P101)
KEY SWITCH	Connector for connecting a key selector switch . If not in use, leave bridged
PHOTO	Removable connector for connecting photocells
SAFETY EDGE	Removable connector for connecting the safety edge <ul style="list-style-type: none"> • For optical safety edges move the jumper between the central pin and the OPTO marking • For resistive or pneumatic safety edges move the jumper between the central pin and the 8k2 marking
1/2 UP	Connector for connecting the partial-opening cam (can only be used with mechanical limit switches)
⚡	Terminal for connecting an external aerial
RADIO	Moulded connector for connecting a compatible Nice radio receiver
LOGIC BOARD	Logic board for controlling the D-Pro Automatic
ENCODER (NU)	Removable connector for connecting an electronic encoder (not used)
ENCODER	Mini-Fit connector for connecting an electronic encoder
LIMIT SWITCH	Removable connector for connecting a mechanical encoder . If an electronic limit switch is used, this connector can be used as an input programmable via parameter P103 (between "COM" and "Pre-Lim").
LP FUSE	F type fuses F4; see chap. 7. PRODUCT SPECIFICATIONS on p. 30
BOOST	Connector for inserting the "boost capacitor" board for single-phase motors. When using three-phase motors or with inverters, bridge the connector on the first two pins as shown in the diagram

2.7 Description of push button panel board

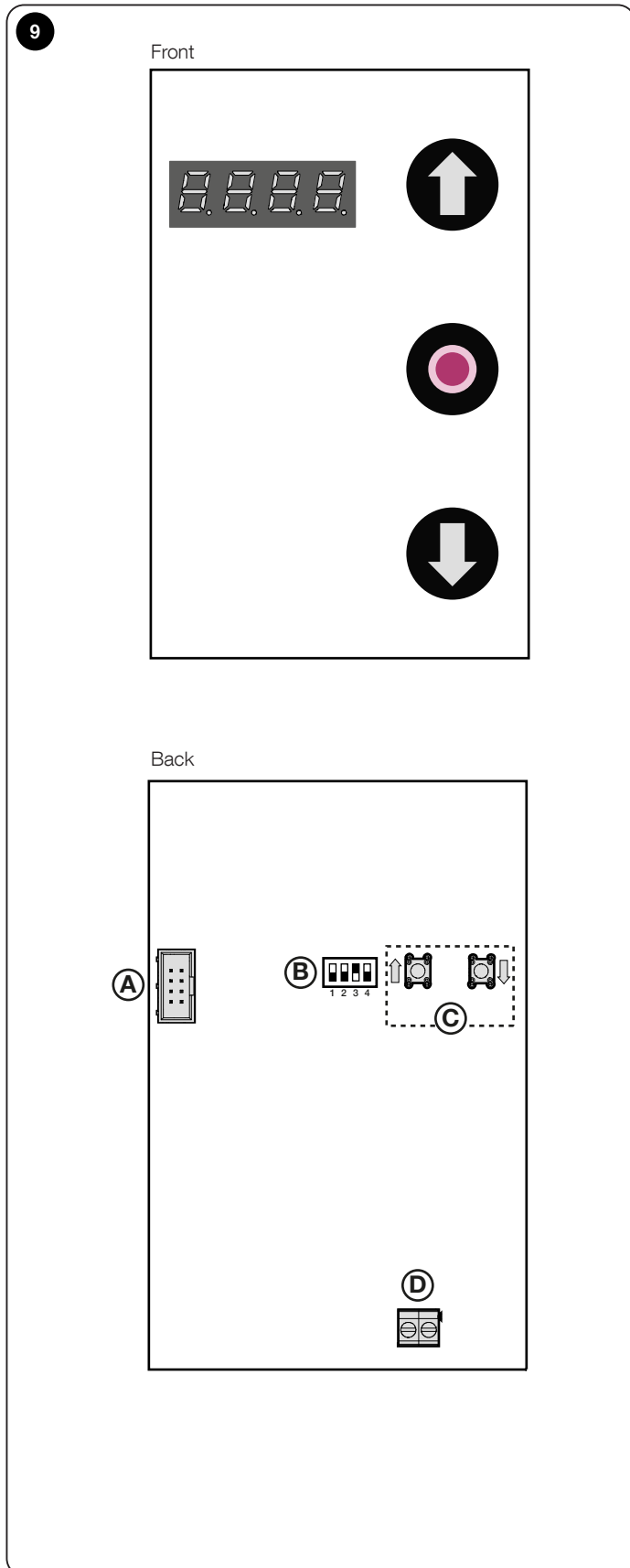

TABLE 5A - Push button panel board

Tag	Description
(A)	Flat-cable connector for communication between push button panel and control unit
(B)	DIP switches for changing control unit parameters and programming (see table below for various configurations)
(C)	Rear buttons for selecting control unit programming
(D)	Connector for external emergency button. Bridge if not in use

TABLE 5B - Display Board - Use of Dip Switches

DIP switch	Description	
1 ON		<p>Access type "P" parameters (see p. 20).</p> <ul style="list-style-type: none"> Use the rear buttons (C) to scroll through the parameters; To change the parameters, raise DIP switch 4 to the desired parameter and use the rear buttons (C) to change the value.
2 ON		<p>Access type "C" parameters (see table on p. 27).</p> <ul style="list-style-type: none"> Use the rear buttons (C) to scroll through the parameters; To change the parameters, raise DIP switch 4 to the desired parameter and use the rear buttons (C) to change the value.
1 and 2 ON		<p>Access type "U" parameters (see table on p. 26).</p> <ul style="list-style-type: none"> Use the rear buttons (C) to scroll through the parameters; To change the parameters, raise DIP switch 4 to the desired parameter and use the rear buttons (C) to change the value. <p>These parameters will only be visible if deletions other than EE_0 have been made.</p>
3 ON		<p>Position fine adjustment (2 encoder increments at a time)</p> <p>See "3.12.1. Position fine adjustment" on p. 16</p>
1,2 and 3 ON		<p>Clear internal memory with control unit reset, essential for inverter initialisation.</p> <p>See par. "3.11 Deleting the control unit memory" on page 14</p>
4 ON		<p>Set opening, closing and partial-opening positions.</p> <p>See par. "3.12 Position learning" on page 15</p>
3 and 4 ON		<p>Change the direction of rotation of the motor.</p> <p>Parameter P75 can also be used.</p> <p>See "3.13 Changing direction of motor rotation" on p. 17</p>

EN

3. ELECTRICAL CONNECTIONS

WARNING!

- All electrical connections must be made while the power is off.
- Connections must only be made by qualified personnel.
- On the power supply line, provide a disconnection device that ensures complete disconnection of the automation from the mains. The disconnection device must have contacts with an opening distance that allows complete disconnection under the conditions of overvoltage category III, in accordance with the installation regulations. If necessary, this device must ensure the power supply is cut quickly and safely; it must therefore be installed within sight of the automation. If it is installed in a non-visible position, it must have a system that blocks any accidental or unauthorised reconnection of the power supply, in order to avoid any danger. The disconnection device is not supplied with the control unit.

IMPORTANT!

We DO NOT RECOMMEND connecting any type of device or accessory not expressly indicated in this instruction manual.

The manufacturer accepts no liability for any damage caused by improper and non-compliant use of the system devices.

For further information, please contact the Nice support service.

3.1 Three-phase power cable connection for NDCC1000 control units

See fig. 7 for information on making the electrical connection.

A 16A CEE plug is connected to terminals L1, L2, L3, N and PE.

Connection to the control unit can also be made using a three-phase main switch (not provided).

In this case, the CEE plug can be removed during assembly.

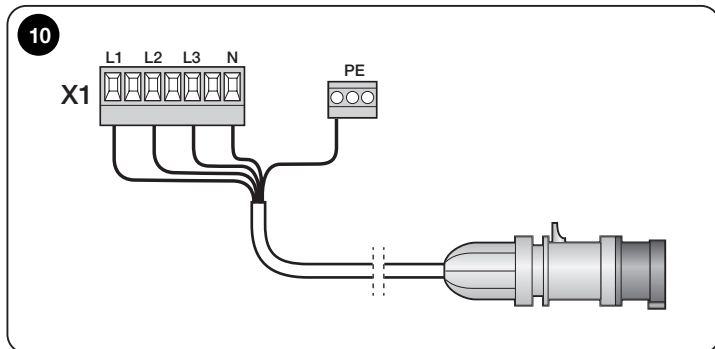

3.2 Single-phase power cable connection for NDCC1100 and NDCC1200 control units

See fig. 6 (motors with inverter) or fig. 5 (single-phase motors with boost board) for information on making the electrical connection.

A Schüko plug is connected to terminals L1, L2 (with an additional connection between L2 and N) and to the PE terminal.

Connection to the control unit can also be made using a single-phase main switch (not provided).

In this case, the Schüko plug can be removed during assembly.

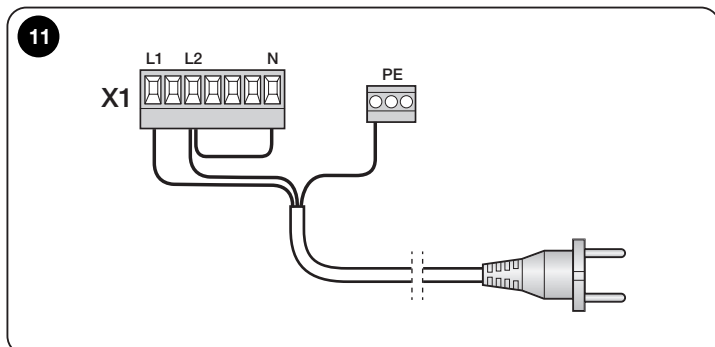

3.3 Electrical connections for the safety edge

By default, activating the safety edge **will cause the door to open fully**. To change this option, see chap. "5. LIST OF PARAMETERS AND ERRORS" on p. 20 - parameter P105.

The task of the SAFETY EDGE input is to stop the manoeuvre in progress immediately and then open the door fully (this option is active by default - for other options see chap. "5. LIST OF PARAMETERS AND ERRORS" on p. 20 - parameter P105).

Devices such as optical safety edges (OSE) or a 8.2 kΩ constant resistance output can be connected to this input.

During the learning phase, the control unit recognises the type of device connected and triggers a "STOP" when there is any variation from the learned state.

3.3.1. Connecting an optical safety edge

If using an **optical safety edge**, which is to be connected as in fig. 12C, change the position of the jumper between the central pin and the "OPTO" marking (fig. 12A).

3.3.2. Connecting a resistive or pneumatic safety edge

If using a **resistive or pneumatic safety edge**, it must be connected as shown in fig. 12B:

- place an 8k2 Ohm resistor in series with the edge;
- change the position of the jumper between the central pin and the 8k2 marking (fig. 12A).

Appropriate steps can be taken to connect more than one device, even of different types, to the STOP SAFETY EDGE input:

- NO devices: connect the 8.2 kΩ resistor **in parallel** to the device;
- NC devices: connect the 8.2 kΩ resistor **in series** to the device;
- several NC devices can be connected "in series" with one another with no quantity limits;
- if several devices are used, all of them must be "cascaded" with a single 8.2 kΩ termination resistor;
- a combination of NO and NC devices can be created, arranging the two contacts "in parallel". In this case, an 8.2 kΩ resistor must be placed "in series" with the NC contact. This also makes it possible to combine three devices: NA, NC and 8.2 kΩ.

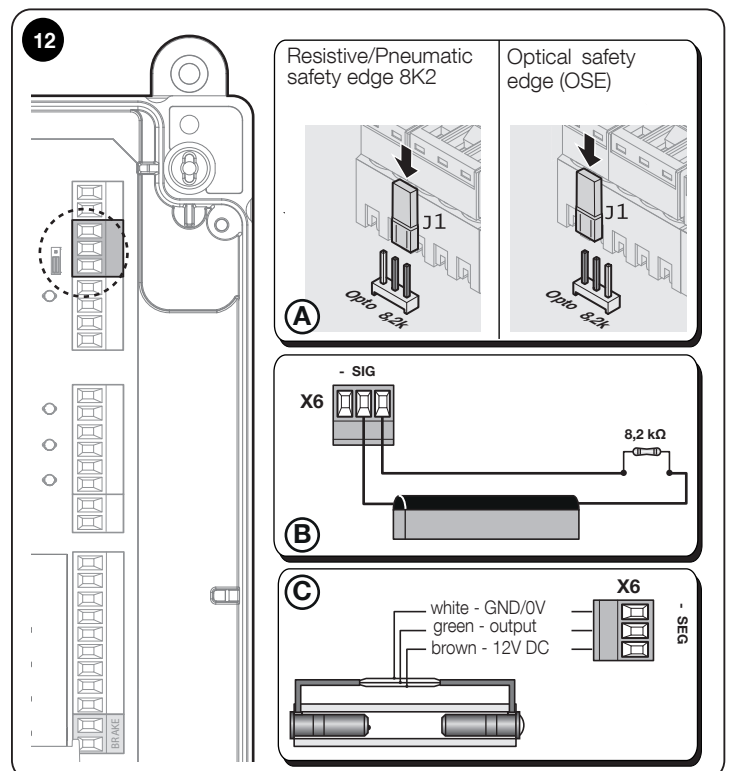

3.4 Electrical connections for photocells

(fig. 13) A photocell can be connected directly to the product's X5 terminal block. The photocell ensures safe transit because, if its infrared beam is interrupted while the door is closing, the door stops and returns to its upper end position (parameter P104 can be used to set different door behaviours if the photocell's infrared beam is interrupted).

WARNING – If using a one-way photocell with 3 connections, the switching contact and the positive power-supply pole on the photocell are connected together to terminal J30/1 with positive potential.

If the photocell is connected, remove the bridge on J31 of terminal block X5!

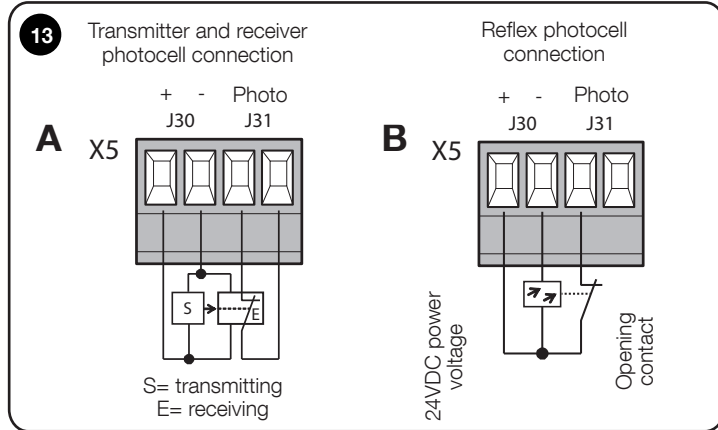

3.5 Electrical connections for external buttons (INPUT)

(fig. 14) For external control, a three-button panel can be connected to D-PRO Automatic at terminal block X4.

The two OPEN and CLOSE buttons must be connected as closing contacts.

The signal received by these inputs can be used to perform several operations depending on the value selected in parameters P100-P102 (see chap. "5. LIST OF PARAMETERS AND ERRORS" on p. 20).

By default they will have the following function:

- UP = OPEN;
- IMP = STEP-BY-STEP;
- DOWN = CLOSE

Since the STOP button is connected to the safety circuit, it must be connected as an opening contact.

If a STOP button is connected to terminal block X4, remove the bridge on terminal J15 and connect the STOP button (opening contact)!

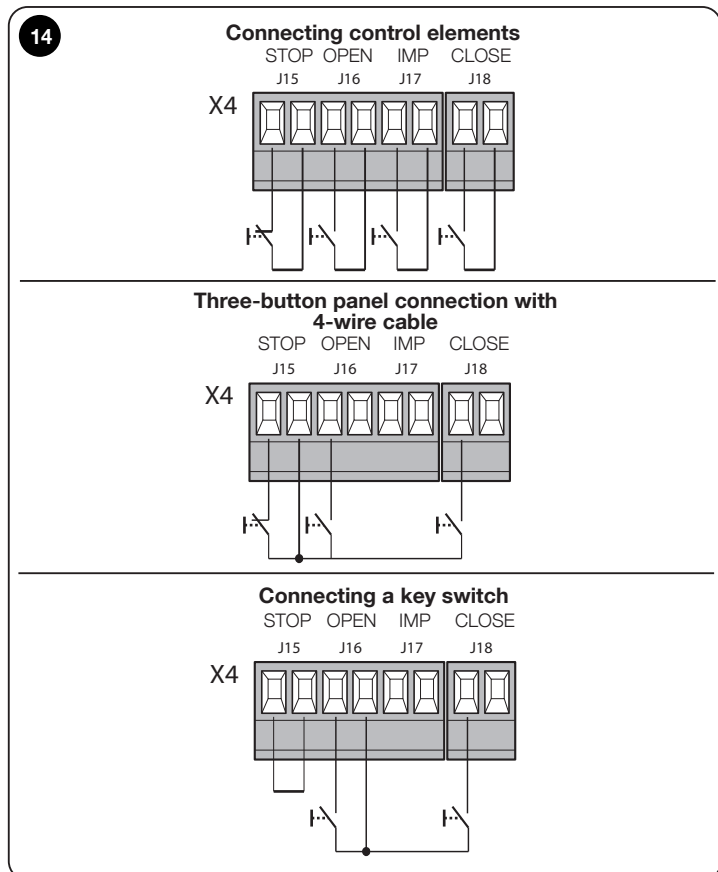

3.6 Electrical connections for signal lights (OUTPUT)

(fig. 15) This control unit is equipped with 3 outputs programmable via parameters P110-P112 (see chap. "5. LIST OF PARAMETERS AND ERRORS" on p. 20).

WARNING! Being dry contacts, any type of load can be connected while staying below the limit set by the relay manufacturer: 10A 250 VAC; 10A 30VDC.

By default, the three outputs switch while giving a signal on the basis of door status:

- OUT 3 (pin 1-2-3) = DOOR CLOSED;
- OUT 2 (pin 4-5-6) = DOOR OPEN;
- OUT 1 (pin 7-8-9) = FLASHING.

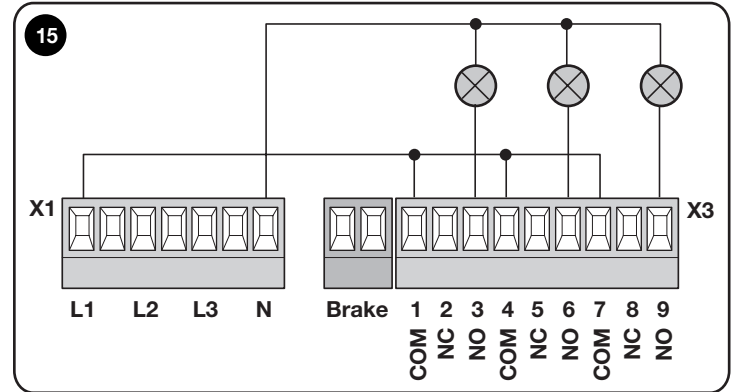

3.7 Control unit electrical connections

WARNING! – All electrical connections must be made while the power is off.

After fastening the control unit box and preparing the holes for routing the electrical cables (see "3.3 Electrical connections for the safety edge" on p. 8), make the electrical connections as follows:

Phase	Description
1	<ul style="list-style-type: none"> • model NDCC1000: see "3.1 Three-phase power cable connection for NDCC1000 control units" on p. 12 • models NDCC1100 and NDCC1200: see "3.2 Single-phase power cable connection for NDCC1100 and NDCC1200 control units" on p. 12
2	Connect the electrical cable coming from the motor: <ul style="list-style-type: none"> • motor with electronic encoder (fig. 16) • motor with mechanical limit switch (fig. 17)
3	Finally, connect the electrical cables of the various accessories (see fig. 9).

Note - To facilitate cable connections, the terminals can be pulled out of their housings.

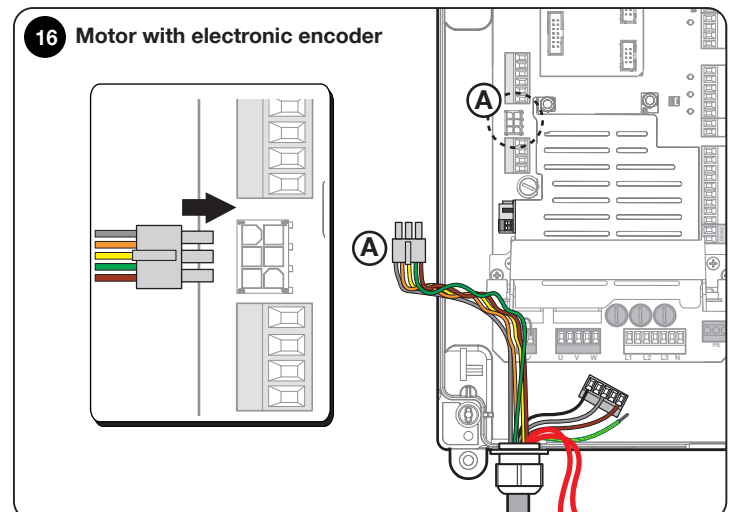

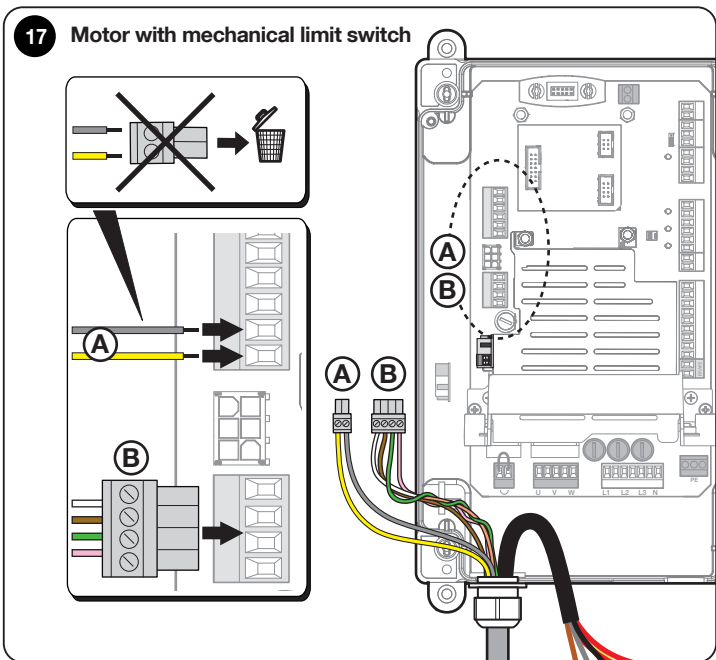

3.8 Connection of a radio receiver

The control unit has an SM connector for connecting a SMXI, SMXIS, OXI, OXIT or OXIBD radio receiver (with Nice one-way radio transmitter) or similar (the radio receiver is an optional accessory, not provided).

To insert the radio receiver, disconnect the control unit from the power supply and insert the receiver as shown in fig.18.

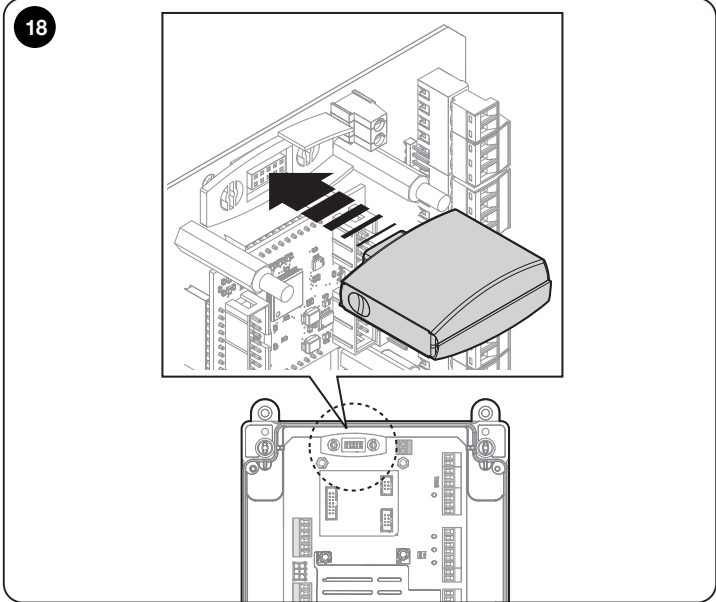

Parameter P106 (see chap. "5. LIST OF PARAMETERS AND ERRORS" on p. 20) lists the actions performed by the control unit depending on the activated outputs or the commands sent by the radio receiver.

Note - For any other information, please refer to the receiver's instruction manual.

To use the radio receiver, set parameter P106 to one of the available values (see chap. "5. LIST OF PARAMETERS AND ERRORS" on p. 20). By default, door movement via radio receiver is deactivated.

3.9 Initial switch-on and checking connections

After supplying power to the control unit, carry out the following checks:

- the green LED U10 (on the logic board) must flash regularly at a frequency of 1 flash per second.
- the photocell LEDs (if present) must flash (RX); the type of flashing is not significant because it depends on other factors.
- the red LED near the safety edge connector is off.

If one or more checks fails, disconnect the control unit from the power supply and check the various electrical connections made previously.

3.10 Resetting door cycles - "Service" error

If the control unit display reads "Service", the number of cycles performed (P1 value) has reached the value set in parameter P2, so maintenance must be performed on the automation. The error, even if present, does not affect the operation of the automation, which can be used normally. Proceed as follows to clear the error:

TABLE 7 - Enabling partial opening		
Number	Operation to be performed	Graphical description
1	"Service" displayed	
2	Set DIP switch 1 to ON	
3	Use the rear buttons to scroll through the parameters to parameter "P1"	
4	Set DIP switch 4 to ON	
5	The display shows the total number of cycles completed by the door. The value is the same as that set in parameter P2 (e.g.: 2000)	
6	Press and hold the two rear buttons for about 2 seconds until the display reads "0"	
7	Set all DIP switches to OFF	

3.11 Deleting the control unit memory

All data stored in the control unit can be deleted and the unit restored to factory settings.

- **Single-phase motors** (only those using the "boost capacitor" board) and **three-phase motors** (380/400V) = "EE_0" type deletion.
 - **Inverter motors** 1.1kW or 2.2kW **without an identification label** on the side of the inverter: EE_1 type deletion.
 - **Inverter motors** 1.1kW or 2.2kW **with an identification label** on the side of the inverter: deletion type stated on label.
- In all three cases, validate the operation by proceeding as follows:

TABLE 8 - Resetting control unit to factory settings		
Phase	Operation to be performed	Graphical description
1	Set DIP switches 1, 2 and 3 to ON	
2	Select the type of deletion to be performed using the rear buttons	
3	Press and hold the two rear buttons simultaneously for about 2 seconds	
4	Release them when the display shows 4 dashes at the bottom	
5	The control unit will reboot showing the firmware version on the display	
7	Set all DIP switches to OFF	

WARNING! – If wishing to change the type of motor from one with an inverter to one without an inverter, perform the EE_0 type deletion before connecting the motor. If the motor is connected before performing the deletion and the control unit is switched on, the motor will run for about 2 seconds (in an unspecified direction), after which the control unit will go into error.

3.12 Position learning

Enter the position setting as indicated on p.15 and p.16. The control unit then autonomously runs 4 complete cycles to improve motor/control unit performance and to comply with the limits (setup) as closely as possible.

WARNING! – Before starting to move the door, make sure it is at least 50 cm above the ground. If not, use the emergency manoeuvre system (see motor instruction manual). This precaution prevents the support cables (sectional doors) slipping out of their seat or the shutter being overwound (rolling shutters) in the event of reverse rotation.

WARNING! – If the direction of rotation does not match the set direction (Open button = opening direction) or error “F06” appears on the display, change the direction of rotation (see “3.13 Changing direction of motor rotation” on p. 17)

WARNING! – DO NOT interrupt the position learning procedure. If this happens, the entire learning procedure must be repeated.

The position learning phase can be repeated at any time, even after installation.

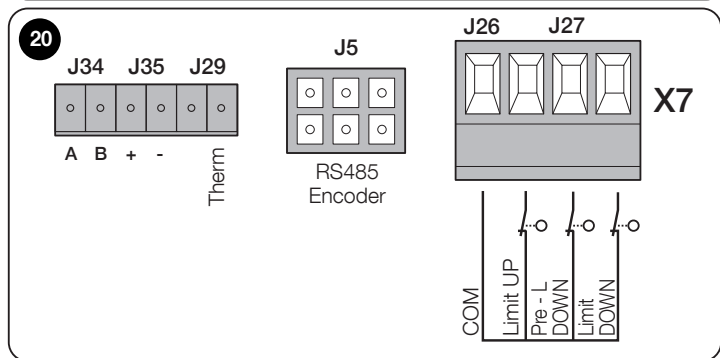
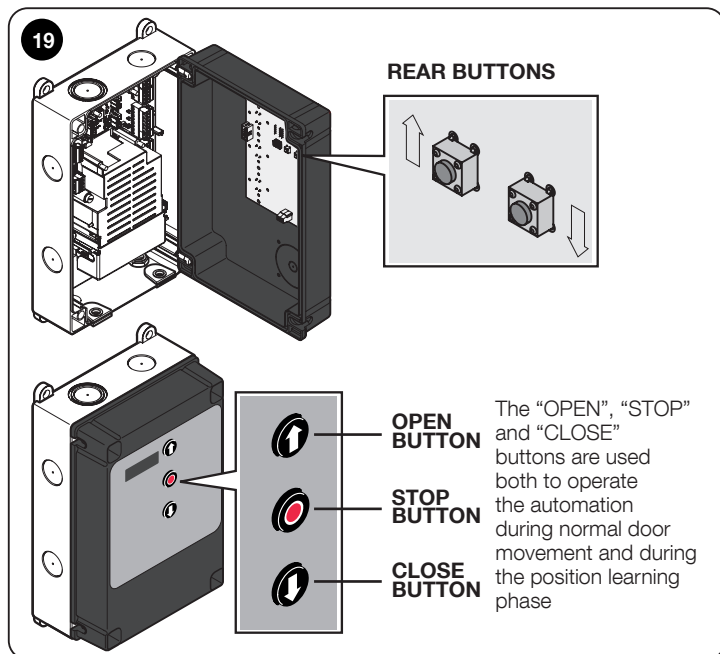

Setting opening and closing positions with ELECTRONIC LIMIT SWITCH (ENCODER)

Three positions can be programmed, as described below:

Position	Meaning
Opening	Maximum opening position. The door stops on reaching this position.
Closure	Maximum closing position. The door stops on reaching this position.
Partial opening	Partially open position. Position at which the door stops after a partial-opening command is given.

WARNING! – Before starting to move the door, make sure it is at least 50 cm above the ground.

Proceed as follows to set the positions with electronic limit switch:

Phase	Operation to be performed	Graphical description
1	Set all DIP switches to OFF	
2	Set DIP switch 4 to ON	
3	The display shows the adjacent image with the top dashes flashing	
4	Use the front button to move the door to the desired maximum opening position	
5	After selecting the maximum opening position, press one of the rear buttons to confirm	
6	The display shows the adjacent image with the bottom dashes flashing	
7	Use the front button to move the door to the desired maximum closing position	
8	After selecting the maximum closing position, press one of the rear buttons to confirm	
9	The display shows the adjacent image with the central dashes flashing	
10	If you do not wish to set a partially open position, skip to phase 14 of this procedure	
11	Use the front button to move the door to the desired partially open position	
12	After selecting the partially open position, press one of the rear buttons to confirm	
13	The display shows only the side bars	
14	Lower DIP switch 4	
15	The display shows "Setup-4"	
16	Give an open or close command using the appropriate buttons on the front of the control unit. Wait for the control unit to finish setup	
7	At the end of the setup, the door will be fully open and the display will show the adjacent "image"	

EN

3.12.1. Position fine adjustment

After learning the positions, if the set limit stop is not in the desired position, the opening and closing limits can be adjusted:

- on DIP switch 3 (TABLE 11A)
- in parameters P10-P11 (TABLE 11B) without having to set the positions again.

Proceed as follows:



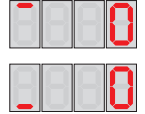
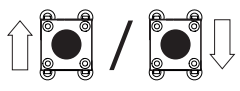



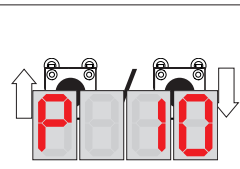

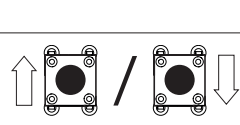

TABLE 11A		
Phase	Operation to be performed using DIP switch 3	Graphical description
1	Set all DIP switches to OFF	
2	Open or close the door fully depending on which limit you wish to adjust	
3	Set DIP switch 3 to ON	
4	The display shows "0" and a dash: • top if the door is open • bottom if the door is closed	
5	Use the rear buttons to increase (raise) or decrease (lower) the limit position	
6	Set all DIP switches to OFF	
7	Give a full open-close or close-open command (depending on where position was changed). Check the door is higher/lower than before	
8	If the new position is still not as desired, repeat the procedure from the beginning	

TABLE 11B		
Phase	Operation to be performed using parameters P10 and P11	Graphical description
1	Set all DIP switches to OFF	
2	Set DIP switch 1 to ON	
3	Scroll to parameter P10 or P11 using the rear buttons	
4	Set DIP switch 4 to ON	
5	The displays shows a 4-digit number indicating: P10 = maximum opening position P11 = maximum closing position	
6	Use the rear buttons to increase (raise) or decrease (lower) the limit position	
7	Once the change has been made, set all DIP switches to OFF	

8	Give a full open-close or close-open command (depending on where position was changed). Check the door is higher/lower than before	
9	If the new position is still not as desired, repeat the procedure from the beginning	





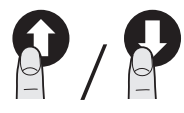

3.12.2. Setting opening and closing positions with MECHANICAL LIMIT SWITCH

Two positions can be programmed, as described below:

TABLE 12 - Setting positions with mechanical limit switch	
Position	Meaning
Opening	Maximum opening position. The door stops on reaching this position.
Closure	Maximum closing position. The door stops on reaching this position

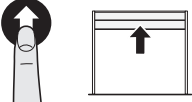
WARNING! – Before starting to move the door, make sure it is at least 50 cm above the ground.

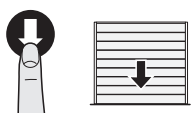
Proceed as follows to set the positions with mechanical limit switch:

TABLE 13		
Phase	Operation to be performed	Graphical description
1	Set all DIP switches to OFF	
2	Use the front button  to move the door to the desired maximum opening position	
3	a) Set contact cam 1 GREEN  to trigger the limit switch b) Tighten fastening screw "A" c) For fine adjustment use screw "B"	see fig. 21
4	Use the front button  to move the door to the desired maximum closing position	
5	a) Set contact cam 3 WHITE  to trigger the limit switch b) Tighten fastening screw "A" c) For fine adjustment use screw "B".	see fig. 21

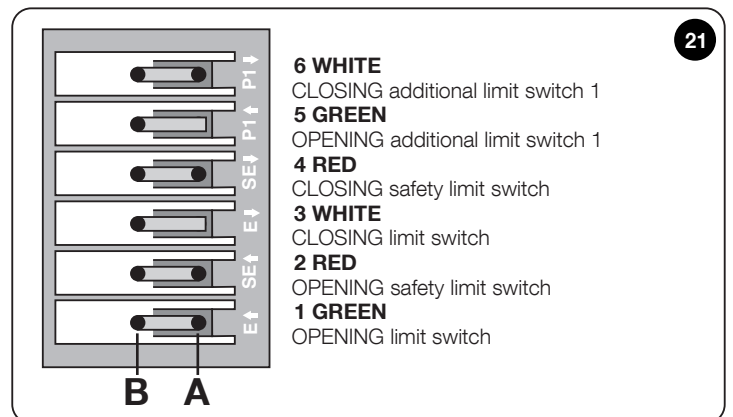

Safety limit switches 2  and 4  (RED, fig. 21) are set at the factory to closely follow the operating limit switch.

After the function test, check the fastening screws are positioned correctly.

The additional limit switches 5 **P1↑** and 6 **P1↓** (GREEN and WHITE, fig. 21) are potential-free switching contacts.

The CLOSING additional limit switch 1 **E↑** (5 **P1↑** and 6 **P1↓**) is used as a preliminary limit switch; therefore, it must be set to trigger when the door reaches a distance of 5 cm from the ground.







The triggering of this limit switch prevents the execution of the "short reverse" manoeuvre.



If the safety edge is triggered, it only performs the STOP. This limit switch must always be connected to the control unit's PRE-CLOSE input.

3.13 Changing direction of motor rotation

If the door moves in the opposite direction to the one desired during the position learning phase, adjust:

- DIP switch 3 (TABLE 14A)
 - parameter P75 (TABLE 14B)
- without having to set the positions again.

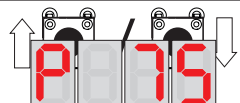
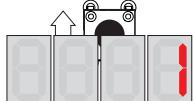
Phase	Operation to be performed using DIP switch 3	Graphical description
1	Set DIP switches 3 and 4 to ON	
2	The display shows two "Ls" upside-down and back to back	
3	Press and hold the rear button located behind the board	
4	Release the button when the display shows the two "Ls" inverted	
5	Set all DIP switches to OFF	
6	Set DIP switch 4 to ON to learn the positions again	





Number	Operation to be performed using parameter P75	Graphical description
1	Set DIP switch 1 to ON	
2	Scroll to parameter P75 using the rear buttons	
3	Use the rear button to change the value from "0" to "1"	
4	Set all DIP switches to OFF to exit the parameters menu	
5	Set DIP switch 4 to ON to learn the positions again	

3.14 Enabling partial opening

The control unit allows a partially open position to be set during the limit switch setting.

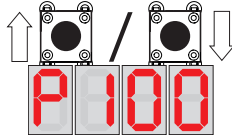
If this position has not yet been set, the half-open option can be used without having to learn the positions again (the door will open exactly halfway between the upper and lower limit stops).

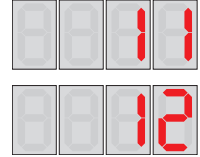
By default, the partially open (or half-open) position is deactivated and can be enabled as follows:

Number	Operation to be performed	Graphical description
1	Set DIP switch 1 to ON	
2	Use the rear buttons to scroll to the parameter relating to the input where you wish to connect the NO contact for enabling partial opening (e.g. UP input - P100)	
3	Set DIP switch 4 to ON	
4	Use the rear buttons to set the parameter value for the chosen input to: • 11 = it will only be possible to perform partial opening and not full opening. • 12 = the next opening command after the one given for partial opening will open the door fully.	
5	Set all DIP switches to OFF	

Enabling the partially open option is valid for both electronic and mechanical limit switches, provided that for the latter, the partial opening cam is connected to input "1/2 UP".

At the end of the procedure, switch the contact connected to the input to activate partial opening.

When an open command is given, the door will stop at the limit set in parameter P12.

4. TESTING AND PUTTING INTO SERVICE

During automation design, the **testing and putting into service phases** are the most important to ensure maximum safety.

The test can also be used to periodically check the devices in the automation. These steps must be carried out by qualified and experienced personnel who will be responsible for running the necessary tests to verify the solutions adopted against the existing risks and to verify compliance with the provisions of laws, standards and regulations, particularly with all the requirements of standard EN 12453, which sets out the test methods for testing gate and door automations.

The **additional devices** must undergo specific testing, both with regard to their functionality and their correct interaction with the control unit. As such, please refer to the instruction manuals of the individual devices for these tests.

4.1 Testing

The sequence of operations to be carried out to run the test, described below, refers to a typical installation (fig.2):

01. Check compliance with that stated in chapter "[GENERAL SAFETY INSTRUCTIONS](#)" on p.4.
02. Release the motor. Check the door can be manually opened and closed with a force of less than 225 Newtons.
03. Lock the motor.
04. Using the control devices (transmitter, control button, key selector switch, etc.), test the opening, closing and stopping of the door, ensuring that the movement of the leaves corresponds to what is expected. Run several tests to assess the movement of the door and identify any assembly or adjustment faults, as well as any particular friction points.
05. Check the correct functioning of all safety devices in the system (photocells, safety edges, etc.) one by one.
06. If dangerous situations caused by the movement of the leaves have been safeguarded by limiting the impact force, the force must be measured in accordance with EN 12453.

4.2 Putting into service

Putting into service can only take place once all test steps ("[4.1 Testing](#)" on p.18) have been carried out successfully on the control unit and the other devices. Partial or "provisional" putting into service is prohibited.

01. **Produce the automation's technical file and keep it for at least 10 years;** the file must include at least: automation assembly drawing, electrical connection diagram, risk analysis and solutions adopted, manufacturer's declaration of conformity of all devices used (for the control unit, use the enclosed EC Declaration of Conformity), copy of the automation instruction manual and maintenance plan.
02. **Affix a plate to the door** stating at least the following data: type of automation, name and address of the manufacturer (responsible for "putting into service"), serial number, year of construction and "CE" mark.
03. Permanently affix a **label or plate stating the manual release and manoeuvre operations near the door.**
04. Permanently affix a **label or plate with this image** to the door (minimum height 60 mm).

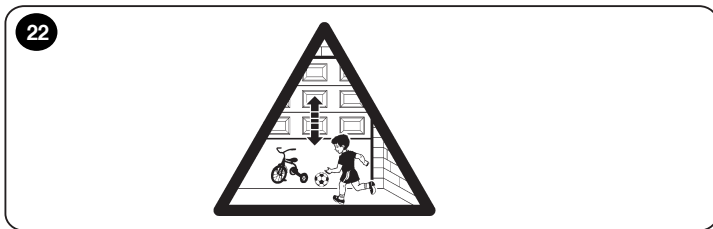

05. Produce the automation's **declaration of conformity** and give it to the owner.
06. Produce the "**Automation use instructions and warnings**" manual and give it to the owner.
07. Produce the **automation maintenance plan** (which must include all maintenance requirements for the individual devices) and give it to the owner.

4.3 Setting a PIN (control unit lockout code)

After checking that the control unit is operating correctly, you may decide to set a control unit lockout PIN that prevents the user from changing parameters, setting positions and deleting the memory.

WARNING – If you forget the access PIN, you can no longer operate the board. Please note down the code after saving it.

4.3.1. Setting the PIN (control unit lockout code)

Proceed as follows to set the control unit lockout PIN.

After rebooting, no more parameters can be changed.

TABLE 16 - Setting the PIN

Phase	Operation to be performed	Graphical description
1	Set DIP switch 2 to ON	
2	Scroll to parameter C2 using the rear buttons	
3	Set DIP switch 4 to ON	
4	Set the PIN (lock/unlock code) using the buttons on the back of the display board (e.g. 3-0-9-2) Note down the PIN entered so as not to forget it later on	
5	Set all DIP switches to ON	
6	Press and hold the two rear buttons simultaneously for about 2 seconds until the set number flashes: the PIN is now saved	
7	Reboot the control unit to activate the code lock	
8	Set all DIP switches to OFF	

4.3.2. Unlocking the control unit (momentary)

Proceed as follows to unlock the control momentarily*:

TABLE 17 - Unlocking the control unit		
Phase	Operation to be performed	Graphical description
1	Set DIP switch 2 to ON. Parameter C1 is displayed	
2	Set DIP switch 4 to ON	
3	Set the PIN (lock/unlock code) using the buttons on the back of the display board (e.g. 3-0-9-2)	
4	While the PIN is displayed, set all DIP switches to OFF	
5	The control unit is now momentarily unlocked (*)	

(*) The control unit is **unlocked momentarily**; in the event of a reboot, it will once again be locked.

If wishing to **permanently unlock** the control unit, follow the procedure described in "[4.3.3. Deactivating the PIN \(control unit lockout code\)](#)" on p. [19](#).

4.3.3. Deactivating the PIN (control unit lockout code)

Proceed as follows to permanently deactivate the control unit lockout PIN.

TABLE 18 - Deactivating the control unit lockout code		
Phase	Operation to be performed	Graphical description
1	Set DIP switch 2 to ON. Parameter C1 is displayed	
2	Set DIP switch 4 to ON	
3	Set the PIN (lock/unlock code) using the buttons on the back of the display board (e.g. 3-0-9-2)	
4	While the PIN is displayed, set DIP switch 4 to OFF	
5	Scroll to parameter C2 using the rear buttons	
6	Set DIP switch 4 to ON	
7	The previously set PIN is displayed (e.g. 3-0-9-2)	
8	Use the rear buttons to change the value to "0" (disabled)	
9	Set all DIP switches to OFF	
10	The control unit is now permanently unlocked	

To reset the control unit lockout PIN at a later date, follow the procedure described in "[4.3.1. Setting the PIN \(control unit lockout code\)](#)" on p. [18](#).

5. LIST OF PARAMETERS AND ERRORS

5.1 Service parameter table - "P" series

Parameter No.	Parameter name	Unit	Minimum value	Maximum value	Default value STD	Default value EE_1	Default value EE_2/EE_3	MLS	ELS	From version
0	Set door positions Button ↑ = Upper limit stop Button ↓ = Lower limit stop Both buttons = Partial opening limit stop	Num.	-	-	-	-	-	-	x	0.33
Maintenance										
1	Cycle counter (1 increment = 10 door cycles)	Num.	0	9999	0	0	0	x	x	0.33
2	Cycles limit for door maintenance	Num.	0	9999	2000	3500	3500	x	x	0.33
3	Restart counter	Num.	0	65535	0	0	0	x	x	0.33
4	Automatic door cycles (waiting time between manoeuvres)	Sec	0	255	0	0	0	x	x	0.33
5	Door status display options 0 = Basic display (with dashes) 1 = Display with dashes during movement and with letters on reaching limit stops 2 = Display all with letters	Num.	0	2	0	0	0	x	x	0.40
6	Storage of last 10 errors	-	-	-	-	-	-	x	x	0.46
Electronic encoder										
10	Upper limit stop	Incr.	0	8191	Off	Off	Off	-	x	0.33
11	Lower limit stop	Incr.	0	8191	Off	Off	Off	-	x	0.33
12	Half-open limit switch (partial opening if set)	Incr.	0	8191	Off	Off	Off	-	x	0.33
13	Pre-limit distance (in relation to lower limit stop)	Incr.	1	700	50	50	50	-	x	0.33
14	Safety limit stop distance	Incr.	0	5000	100	250	250	-	x	0.33
15	Nice encoder firmware version	Num.	0	-	-	-	-	-	x	0.33
16	Number of operating hours run by Nice encoder	Hours	0	9999	-	-	-	-	x	0.33
17	Minimum distance for photocell trigger (see also parameter P104)	Incr.	0	8191	Off	Off	Off	-	x	0.57
Overrun control										
20	Adjustment of maximum overrun correction	Incr.	0	240	2	2	2	-	x	0.33
21	Maximum overrun correction for upper limit stop (can only be set if P20 = 0)	Incr.	0	200	50	70	70	-	x	0.33
22	Maximum overrun correction for lower limit stop (can only be set if P20 = 0)	Incr.	0	200	50	70	70	-	x	0.33
23	Initial overrun at upper limit stop	Incr.	ro	-	-	-	-	-	x	0.33
24	Initial overrun at lower limit stop	Incr.	ro	-	-	-	-	-	x	0.33
Adjustment of automatic ground adaptation										
30	Automatic ground adaptation options: 0 = No automatic ground adaptation 1 = Limited to lower limit stop 2 = Including downward correction	Num.	0	2	0	0	0	-	x	0.33
31	Maximum encoder increments for ground search	Incr	0	240	5	5	5	-	x	0.33
32	Maximum limit for ground adaptation beyond lower limit stop (default maximum limit P11 - 50)	Incr.	0	8191	P11-50	P11-50	P11-50	-	x	0.33
33	Minimum height (in percent) to validate ground adaptation	%	0	100	30	30	30	-	x	0.33
Automatic closing / Air curtain										
40	Automatic closing options 0 = Standard automatic closing 1 = Automatic closing is not disabled by pressing the STOP button 2 = All commands ignored during waiting time 3 = Automatic closing activates regardless of door position	Num.	0	3	0	0	0	x	x	0.33 0.45 1.44
41	Waiting time for automatic closing 0 = Automatic closing deactivated	Sec	0	9999	0	0	0	x	x	0.33
42	Traffic light warning time	1/10 Sec	0	240	0	0	0	x	x	0.33
43	Waiting time for automatic closing if photocells are activated 0 = Disabled	Sec	0	240	0	0	0	x	x	0.33
44	Disabling of automatic closing after n attempts to trigger safety edge 0 = Not disabled 1 = Disabled after 1 attempt 2-5 = Disabled after n attempts	Num.	0	5	3	3	3	x	x	0.33 1.33 0.33
45	Time delay for air curtain deactivation	Sec	0	9999	0	0	0	x	x	1.05

Parameter No.	Parameter name	Unit	Minimum value	Maximum value	Default value STD	Default value EE_1	Default value EE_2/EE_3	MLS	ELS	From version
46	Traffic light warning activation options 0 = Warning only if door is at upper limit stop 1 = Warning after closing command regardless of door position	Num.	0	1	0	0	0	x	x	1.44
High speed doors / Inverter										
50	Brake control options (solely for EE_0 and EE_1 deletion) 0 = No brake connected 1 = Brake connected	Num.	0	1	1	1	-	x	x	0.33
51	Brake activation delay during opening manoeuvre (solely for EE_0 and EE_1 deletion)	10 ms	0	50	12	10	-	x	x	0.33
52	Brake deactivation delay during opening manoeuvre (solely for EE_0 and EE_1 deletion)	10 ms	0	50	4	4	-	x	x	0.33
53	Brake activation delay during closing manoeuvre (solely for EE_0 and EE_1 deletion)	10 ms	0	50	12	10	-	x	x	0.33
54	Brake deactivation delay during closing manoeuvre (solely for EE_0 and EE_1 deletion)	10 ms	0	50	4	4	-	x	x	0.33
55	Duration of slow speed (or creep) for reaching upper limit stop	10 ms	20	250	70	70	70	-	x	1.37
56	Duration of slow speed (or creep) for reaching lower limit stop	10 ms	10	250	15	15	15	-	x	1.37
57	Brake activation below minimum speed detected by encoder (solely for EE_0 and EE_1 deletion)	Incr	0	50	0	10	-	-	x	0.37
58	Brake activation delay in case of emergency stop	ms	0	500	0	10	10	-	x	0.37
59	Range of fast closing distance calculated from upper limit stop To set, press and hold the STOP button for about 2 seconds	Incr	0	5000	0	0	0	-	x	1.08
Time monitoring										
60	Modes for monitoring manoeuvre run time 0 = Monitoring disabled or active for tubular motors 1 = Automatic mode (only with electronic limit switch) 2 = Manual mode 3 = Manual mode, including minimum time monitoring (only for inverters)	Num.	0	4	2	3	3	x	x	0.33
61	Maximum run time (full manoeuvre)	Sec.	0	240	60	10	10	x	x	0.33
62	Maximum run time (partial opening)	Sec.	0	240	60	6	6	x	x	0.33
63	Minimum run time (full manoeuvre) for motors with inverter	1/10 s	0	240	0	20	20	x	x	0.33
64	Manoeuvre average run time	1/10 s	0	-	-	-	-	x	x	0.33
65	Last run time performed by door	1/10 s	0	-	-	-	-	x	x	0.33
Door control										
70	Door operation selection 0 = Standard operation (single-phase and three-phase motors) 1 = Motor operation with Nice inverters without label 2 = Not used 3 = Motor operation with Nice inverters with label EE_2 and EE_3 4 = Tubular motor operation	Num.	0	4	0	1	3	x	x	1.32
71	Main contactor activation delay	ms	0	250	0	0	0	x	x	0.33
72	Direction relay deactivation delay	ms	15	250	23	23	23	x	x	0.33
73	Rotation direction inversion delay	10 ms	6	250	70	70	70	x	x	0.33
74	Time delay for inverting run direction following safety edge trigger	10 ms	3	250	4	4	4	x	x	0.33
75	Run direction (can also be changed with DIP switches 3 and 4 ON) 0 = No change to motor direction of rotation 1 = Change motor direction of rotation	Num.	0	1	0	0	0	x	x	1.53
76	Motor starting capacitor activation time (single-phase motors only)	1/10 s	0	50	15	0	0	x	x	0.50
77	Auto safety test delay	10 ms	10	250	25	25	25	x	x	0.63

Parameter No.	Parameter name	Unit	Minimum value	Maximum value	Default value STD	Default value EE_1	Default value EE_2/EE_3	MLS	ELS	From version
78	Electronic encoder selection 0 = Standard encoder 1 = Special encoder To set, press and hold the STOP button for about 2 seconds	Num.	0	1	0	0	0	x	x	0.80
Traffic light / door bolt										
80	Traffic light selection options (NDA030 board only) 0 = Traffic light deactivated 1 = Traffic light flashes during manoeuvre 2 = Traffic light on steady during manoeuvre 3 = Red/green traffic light for loading ramps (green light for door open, red light during manoeuvre and when door closed)	Num.	0	3	0	0	0	x	x	0.33
81	Traffic light options If set to 1, it will change the following parameters: P100 = 10 ("UP" input on connector X4 - Open externally) P110 = 10 (Relay 1 - Internal red/green light) P111 = 11 (Relay 2 - External red/green light) P112 = 12 (Relay 3 - Traffic light on/off at entrance) To set, press and hold the STOP button for about 2 seconds	Num.	0	1	0	0	0	x	x	0.33
82	Warning time for door opening with flashing traffic light	Sec	0	240	0	0	0	x	x	0.33
83	Waiting time for door opening after external opening command	1/10 s	0	24.0	0	0	0	x	x	0.33
84	Waiting time before closing door bolt	1/10 s	0	24.0	1.0	1.0	1.0	x	x	0.51
85	Extended pressing time for locking door bolt	1/10 s	0	24.0	2.0	2.0	2.0	x	x	0.51
86	Extended pressing time for unlocking door bolt	1/10 s	0	24.0	2.0	2.0	2.0	x	x	0.51
87	Timeout for locking/unlocking door bolt	1/10 s	0	24.0	24.0	24.0	24.0	x	x	0.70
88	Power transmission activation time (only for wireless safety edges)	Min	0	255	60	60	60	x	x	1.67
89	Wait time before power transmission (only for wireless safety edges)	Min	0	9999	1440	1440	1440	x	x	1.64
Loop detector (K70 board) (No longer used)										
90	Loop detector options (K70)	-	-	-	-	-	-	x	x	0.70
91	Locking time in case of cross traffic	-	-	-	-	-	-	x	x	0.70
Options for inputs										
100	UP input options (Connector X4 - J16) 0 = Opening by internal control 10 = Opening by external control 11 = Enable partial opening 12 = Enable partial opening - next command will open door fully 13 = Enable automatic closing (See parameters P40-46) 14 = Enable man-present mode 15 = Opening from outside with ISO loading ramp 16 = Lock for opening command 17 = Fire detection (with sensor) - close door 18 = Fire detection (with sensor) - open door 19 = Fire detection (with sensor) - partially open door 20 = Door bolt detection sensor 21 = Lock for closing command 22 = Opening command for partial opening 23 = Lock front panel open and close buttons	Num.	0	23	0	0	0	x	x	0.33
								x	x	0.35
								x	x	0.53
								x	x	0.97
								x	x	1.08
								x	x	1.38
101	DOWN input options (Connector X4 - J18) 0 = Closing by internal control 1 = Closing by internal control with 5-second wait before manoeuvre starts 10 - 23 = as for P100	Num.	0	23	0	0	0	x	x	0.33
102	IMP input options (Connector X4 - J17) 0 = Signal input (pull cord) 1 = Step-by-step input (closes if door open) 10 - 23 = as for P100	Num.	0	23	0	0	0	x	x	0.33
103	PRE LIMIT input options (Connector X7 - COM & Pre-L DOWN) 0 = Partial opening (only for mechanical limit switch) 10 - 23 = as for P100	Num.	0	23	0	0	0	x	x	0.33
104	Photocell input options (Connector X5 - J31) 0 = Open door (close door from upper limit stop on P43 > 0) 1 = Open door only above the position set in P17 (by changing the value of P104 from 0 to 1, the current door position will be saved automatically in P17) 2 = The door will stop if the input is activated 10 - 23 = as for P100	Num.	0	23	0	0	0	x	x	0.33
								x	x	1.38
								x	x	0.33

Parameter No.	Parameter name	Unit	Minimum value	Maximum value	Default value STD	Default value EE_1	Default value EE_2/EE_3	MLS	ELS	From version
105	Options for safety edge and man-present mode (Connector X5 - J32) 0 = Optical or resistive safety edge connected 1 = Pneumatic safety edge connected 2 = Electrical safety edge connected, but only with inversion 3 = Pneumatic edge connected, but only with inversion 4 = No safety edge connected - close only when man present 5 = No safety edge connected - close also possible in industrial mode (semi-automatic opening and closure when man present) 6 = No safety edge connected - open and close always when man present 7 = SBA sensor connected 8 = Beam safety edge (dipped beam) - within the pre-limit, edge activation ignored 9 = Safety edge activation works in both directions with a short reverse (sliding gates) 10 = Electrical safety edge connected - stop without reverse, open only when man present 11 = Electrical safety edge connected - 0.5s reverse, open only when man present 12 = Electrical safety edge connected - full door opening, close when man present	Num.	0	12	0	0	0	x	x	0.33
	x							x	0.96	
	x							x	1.16	
	x							x	1.30	
	x							x	1.31	
106	Radio receiver options 0 = No radio receiver connected 1 = Normal operations as per command (OPEN - STOP - CLOSE) 2 = Open from inside 3 = Open from outside 4 = Apartment-block step-by-step	Num.	0	4	0	0	0	x	x	0.33
	x							x	1.29	
107	Options for front panel buttons 0 = Normal operation 1 = Front panel buttons locked	Num.	0	1	0	0	0	x	x	0.53
Options for outputs										
110	Options for relay 3 (X3 pins 1-2-3) 0 = Door closed signal 10 = Door status signal via internal red/green traffic light 11 = Door status signal via external red/green traffic light 12 = Door movement status signal - light on/off 13 = Static signal in case of error 14 = Close door bolt (see also parameter P84) 15 = Open door bolt (see also parameter P85) 16 = Signal when moving door is detected 17 = Optical (or light) grid test 18 = Alarm when door stays open for more than 30s 19 = Radio safety edge test 20 = Air curtain activation (see also parameter P45) 21 = Connection of a relay to control an additional brake 22 = Power transmission activation (for loading radio safety edges. See also parameters P88-P89) 23 = Fire alarm 24 = Door opening signal 25 = Door closing signal	Num.	0	25	0	0	0	x	x	0.33
	x							x	1.12	
	x							x	1.42	
	x							x	1.46	
	x							x	1.49	
	x							x	1.49	
111	Options for relay 2 (X3 pins 4-5-6) 0 = Door open signal 10 - 25 = as for P110	Num.	0	25	0	0	0	x	x	0.33

Parameter No.	Parameter name	Unit	Minimum value	Maximum value	Default value STD	Default value EE_1	Default value EE_2/EE_3	MLS	ELS	From version
112	Options for relay 1 (X3 pins 7-8-9)							x	x	0.33
	0 = Traffic light manoeuvre indicator flashing 1 = Traffic light manoeuvre indicator on steady 2 = Traffic light manoeuvre indicator flashing but only during manoeuvre (off when door stationary) 3 = Traffic light manoeuvre indicator on steady but only during manoeuvre (off when door stationary) 10 - 25 = as for P110	Num.	0	25	0	0	0	x	x	1.76
Options for NDA030 board inputs										
120	Input 1 option 0 = Secondary photocell 10 - 23 = as for P100	Num.	0	23	0	0	0	x	x	0.80
121	Input 2 option 0 = Open from outside 10 - 23 = as for P100	Num.	0	23	0	0	0	x	x	0.80
122	Input 3 option 0 = Enable partial opening 10 - 23 = as for P100	Num.	0	23	0	0	0	x	x	0.80
123	Input 4 option 0 = Enable automatic closing 10 - 23 = as for P100	Num.	0	23	0	0	0	x	x	0.80
124	Input 5 option 0 = Enable man-present movement mode 10 - 23 = as for P100	Num.	0	23	0	0	0	x	x	0.80
125	Input 6 option 0 = Fire detection - close door 10 - 23 = as for P100	Num.	0	23	0	0	0	x	x	0.80
Options for NDA030 board outputs										
130	Relay output 1 options (NO) 0 = Door open signal 10 - 25 = as for P110	Num.	0	25	0	0	0	x	x	0.80
131	Relay output 2 options (NO) 0 = Door closed signal 10 - 25 = as for P110	Num.	0	25	0	0	0	x	x	0.80
132	Relay output 3 options (NO) 0 = No active function by default 1 = Test of first set of photocells 10 - 25 = as for P110	Num.	0	25	0	0	0	x	x	0.80
133	Relay output 4 options (NO) 0 = No active function by default 1 = Test of second set of photocells 10 - 25 = as for P110	Num.	0	25	0	0	0	x	x	0.80
Additional parameters										
140	Short reverse time following safety edge trigger (see also parameter P105)	1/10 Sec	0	250	0	0	0	x	x	1.70

5.1.1. Automatic door cycles – P4

If wishing to perform tests by running continuous automatic cycles on the control units, parameter P4 can be used. This parameter, by default set to 0 (function disabled), allows the door to be moved every n seconds as set in P4. For example, if P4 = 10, each time the door reaches a limit stop (upper or lower), P4 starts a 10s count; once this time has elapsed, the door will open/close automatically. To disable this function, simply press and hold the STOP button on the front panel for 3 seconds. If the STOP button is pressed once, the count will restart from 0.

5.1.2. Overrun correction via brake activation – P20-P22

Parameter P20 is used to set the maximum deviation permitted by the control unit during the stop phase at the set limit stop. During setup after the position learning phase, the control unit automatically sets 2 values (P21 and P22) for brake activation to ensure that the door always stops at the same point. The tolerance of this deviation is set in this parameter and is valid for both parameters. If you wish to set 2 separate values for the closing and opening limit switches, you can change the individual values by setting P20 = 0 and manually changing P21 (for the opening limit switch) and P22 (for the closing limit switch).

5.1.3. Maximum permissible deviation from set limit switches - P14

During the position learning phase, the door must settle and the control unit must be able to work out the limit stops. During this phase, the door may exceed the set limit switch (upper or lower) and the control unit return error F08. To solve this problem (overrun), the door must first be raised or lowered to a known position within the set range. Then parameter P14, which adjusts the maximum tolerance, expressed in encoder increments, with respect to the set limit switch, is set. Increasing this value will increase the tolerance; decreasing it will decrease the tolerance. By default, three-phase and single-phase motors have lower values (P14 = 100) than inverter-controlled motors (P14 = 250). This is because the inverter has to manage acceleration and deceleration ramps, and the door may exceed the set limit stop, albeit only slightly, during installation.

5.1.4. Automatic ground adaptation – P30-P33

After learning the positions, parameter P30 can be set to make the door automatically adjust its closing position over time. This option is made available particularly for doors that tend to “elongate” over time. Parameter P30 manages the type of adjustment to be made. The adjustment is made by increasing or decreasing the position of the lower limit stop by “n” encoder increments set in parameter P31. If the value of P30 is 2, i.e. the adjustment is also performed downwards, parameter P32 is used to set the maximum value, again expressed in encoder increments, beyond which the door cannot correct its position: this is to avoid breaking the door. Parameter P33, on the other hand, is used to set the percentage of height that the door must reach before the correction is made and stored in the memory.

5.1.5. Power transmission for wireless safety edges – P88-P89 and P100-P112

If an output P110-P112 is set to 22, a power transmission charger can be connected for the wireless safety edge. Parameter P88 is used to set the time for which the output remains active and consequently the safety edge battery is allowed to charge, while parameter P89 is used to set the waiting time before the output reactivates the charging of the safety edge battery

5.1.6. Air curtain - P45 and P110-P112

If air curtains are installed, parameter P45 could be useful to set a waiting time before the curtain is deactivated. The time for deactivation will start to count down once the door has completed the closing manoeuvre and reached the lower limit stop. The output for activating the curtain can be set in parameters P110-P112 using the appropriate value

5.1.7. Brake management for inverters without identification label - P50-P54 and P57-P58

Unlike labelled inverters, which can manage brake activation via parameters U40-U41, brake management for unlabelled inverters will only be possible via parameters P50-P54 (see “P” series parameters table) and P57-P58. Below is an in-depth description of the latter 2 parameters:

- **P57:** used to set the range within which the brake must be activated, in the event that the control unit, on detecting the triggering of the safety edge, realises that the reverse speed is too slow compared to the expected speed. If, however, the speed is too low within the range set in P57, the control unit will activate the brake to prevent breakages in the system

- **P58:** used to set a slight delay relating to the activation of the emergency STOP. By default, this parameter is set to a very low, almost instantaneous, value so that when the emergency STOP activates, the door will immediately stop (disconnecting the inverter, if present, until the stop button is reset)

5.1.8. Alternative display - P5

This parameter can be used to change the door's display from the default symbols to characters. In addition, if value 1 or 2 is set, different “E.xxx” warnings will be displayed for each button pressed or input activated

P5 = 1: Text display of limit stops: similar to P5 = 0, but the display shows “OP” when the door reaches the upper limit stop and “CL” when it reaches the lower limit stop

P5 = 2: Text display of door movement: similar to above, instead of showing dashes to indicate the direction of the manoeuvre the display shows “OPn” during the opening manoeuvre and “CLS” during the closing manoeuvre

E.101	DOWN input activation (external)
E.102	UP input activation (external)
E.103	IMP input activation (external)
E.104	Photocell activation (can also be displayed with P5 = 0)
E.105	Loop detector 1
E.106	Loop detector 2
E.107	Radio control (visible after changing parameter P106)
E.161	Emergency stop
E.201	Press the DOWN button on the front panel
E.202	Press the UP button on the front panel
E.360	Safety edge trigger

5.2 Inverter setting parameter table – “U” series

Number	Name	Unit	Minimum value	Maximum value	Default EE_1	Default EE_2	Default EE_3	
Maintenance								
1	Type of device	Number	-	-	-	-	-	
2	Version (number)	Number	-	-	-	-	-	
3	Version (date)	Number	-	-	-	-	-	
4	Version (year)	Number	-	-	-	-	-	
5	Memory of detected short-circuits	Number	0	30	0	0	0	
Speed								
10	Slow (or creep) frequency	Hz	2	187	19	20	17	
11	Opening frequency	Hz	2	187	60	50	70	
12	Slow closing frequency	Hz	2	187	35	30	45	
13	Fast closing frequency (see also P59)	Hz	2	187	60	50	50	
Motor power management								
20	Minimum frequency	Hz	2	20	10	5	10	
21	Minimum voltage	Volt	10	69	69	20	23	
22	Nominal frequency	Hz	40	187	50	40	47	
23	Emergency nominal frequency	Hz	30	187	42	40	46	
24	Maximum absorbed current for each motor phase	1/10 A	3	13.5	13.5	13.5	13.5	
25	Injection of a DC current	Number	1000	2500	1000	1000	1000	
26	Duration of DC current injection	Sec	100	600	600	600	600	
Ramps								
30	Acceleration ramp for opening manoeuvre	1/10 Sec	2	50	4	10	15	
31	Acceleration ramp for closing manoeuvre	1/10 Sec	2	50	4	10	10	
32	Deceleration ramp for opening manoeuvre	1/10 Sec	2	50	3	3	3	
33	Deceleration ramp for closing manoeuvre	1/10 Sec	2	50	3	3	3	
34	Deceleration ramp for stop	1/10 Sec	2	50	3	3	1	
Brake management								
40	Brake deactivation frequency	Hz	0	50	Not managed	7	11	
41	Brake activation frequency	Hz	0	50	Not managed	7	12	
Inverter monitoring								
50	Inverter power voltage	Volt	-	-	-	-	-	
51	Inverter temperature (NTC)	Deg	-	-	-	-	-	
P70	Door operation selection	Number	0	4	1	3	3	

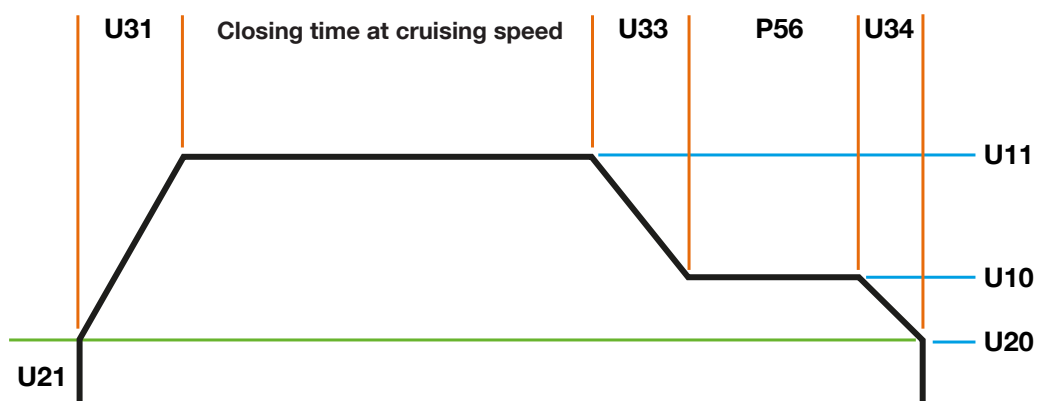
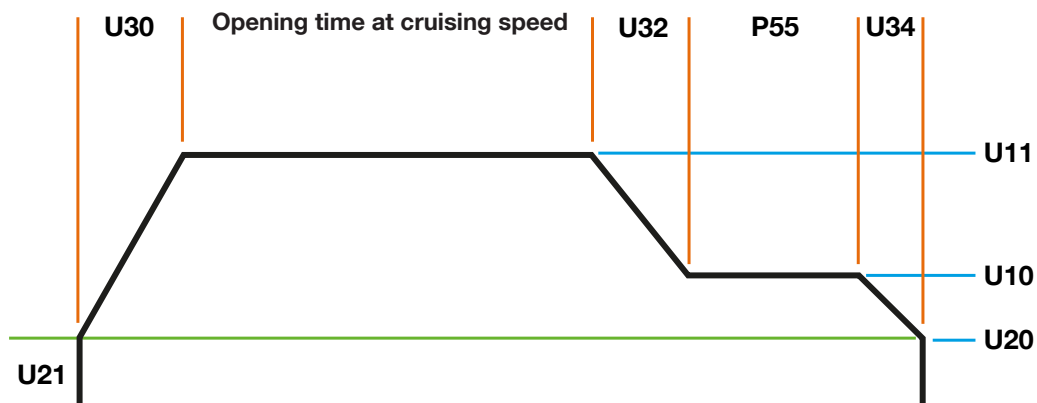

5.3 Service parameter table - "C" series

Parameter number	Name	Unit	Minimum value	Maximum value	Default value	From version
1	Code entry for control unit unlocking	Number	0	9999	0	0.40
2	Code saving for control unit locking/ unlocking	Number	0	9999	0	0.40
3	Software identification number (must be 410)	Number	ro	-	410	0.40
4	Software subversion (must be 400)	Number	ro	1000	-	0.40
5	Lock set by service 0 = No lock set 1 = Lock set	Number	0	1	0	0.40
6	Direction monitoring tolerance	Number	1	20	5	0.69
7	Options relating to F24 error 0 = Complete voltage control 1 = Control suppressed when door in motion 2 = Control completely suppressed	Number	0	2	1	0.72
8	Options relating to F6 error 0 = No change 1 = Direction of rotation control deactivated	Number	0	1	0	0.89
9	Waiting time for direction change relays	ms	2	100	10	1.31

5.4 D-Pro Automatic errors list

TABLE 19 A - Control unit errors list		
Error	Description	Solution
F02	Fault detected during safety edge test	Close the door in man-present mode and with the door closed press the stop button on the front panel. If the error persists, check the integrity of the safety edge
F03	The safety edge detected an obstacle during the closing manoeuvre	Check if an obstacle is actually present and remove it. If the error persists, check that the safety edge is not broken, that the control unit connections are correct as per the manual and, if using pneumatic edges, that the piston has not jammed
F04	The door did not reach the lower limit stop within the time set in P61	Press the STOP button on the front panel The timer can be removed by setting P60 = 0
F05	The door did not reach the upper limit stop within the time set in P61	Press the STOP button on the front panel The timer can be removed by setting P60 = 0
F06	The motor direction of rotation is incorrect	Press the STOP button on the front panel. Invert the motor direction of rotation
F07	Error in photocell test on NDA030 board	Press the STOP button on the front panel to attempt a new photocell test. The control unit automatically clears the error as soon as the test is successful
F08	The door position is outside the set limit stops	Move the door to a known position (between upper and lower limit stops) by manual movement (manual release) or by using DIP switch 4 to raise (in case of lower limit stop overrun) or lower (in case of upper limit stop overrun) the door. When finished, return DIP switch 4 to OFF position
F09	Communication problem on I2C bus	Reboot the control unit
F10	Communication error with electronic encoder (encoder disconnected or broken)	The error will clear automatically as soon as the connection to the encoder and communication with it is restored
F13	Error in release cord test (cord loose)	Check that the manual release cord is not loose
F14	EEPROM checksum error (serious error)	Reset the control unit to factory settings. If the error persists even after resetting, contact a technician
F15	Input photocell activation on NDA030 board. The error appears if the photocell is activated before the door has reached the upper limit stop	Close the door in man-present mode and then press the STOP button on the front panel.
F16	The door reached the limit stop faster than the time set in P63	Press the STOP button on the front panel. If the error reappears, change the minimum time by changing the value in P63 or disable the function by setting P60 = 0
F17	The loop on channel 1 of the loop detector is disconnected	The error will clear automatically as soon as the loop is correctly reconnected to the board
F18	The loop on channel 2 of the loop detector is disconnected	The error will clear automatically as soon as the loop is correctly reconnected to the board
F19	The "Fire detector" input on the NDA030 board is activated	The error will clear automatically as soon as the input is no longer active
F20	After the number of attempts made, set in P44, automatic closing was interrupted Automatic closing will be automatically disabled	Check there are no obstacles preventing the door from closing correctly. Press the STOP on the front panel to clear the error.
F21 SERVICE	"Service" is always displayed. Indicates a system maintenance request after the number of cycles performed by the system has exceeded the number of cycles set in P2	Request the assistance of a technician who will reset the cycle counter and service the system
F22	Encoder error (only valid for Kostal encoders)	Press the STOP button on the front panel
F23	Communication with Nice inverter interrupted	Press the STOP button on the front panel. If a second error from the F2xx or E2xx series appears, see the "inverter errors" table. If the error persists, ensure you have correctly deleted it or contact technical support.
F24	Fault detected on motor drive relay contact	Press the STOP button on the front panel. If the error persists, call a technician
F25	Fault detected on contact of the motor direction relays	Press the STOP button on the front panel. If the error persists, call a technician
F26	Communication error with Nice inverter (generic error)	Press the STOP button on the front panel
F27	Communication error with Nice inverter (command rejected by inverter)	Press the STOP button on the front panel. If the error persists, switch off the control unit and wait approximately one minute before switching it back on
F28	Communication error with Nice inverter (timeout after n seconds of no inverter response)	Press the STOP button on the front panel. If the error persists, switch off the control unit and wait approximately one minute before switching it back on
F29	Door bolt fails to lock/unlock within the time set in P87	Press the STOP button on the front panel. If the error persists, check the door bolt lock is not broken
F30	Communication error with Nice inverter (wrong inverter address)	Press the STOP button on the front panel. If the error persists, switch off the control unit and wait approximately one minute before switching it back on
F32	Communication error with Nice inverter (inverter did not activate correctly)	Press the STOP button on the front panel. If the error persists, switch off the control unit and wait approximately one minute before switching it back on
F33	Fault detected on brake control relay contact (only for D-Pro Automatic R10)	Press the STOP button on the front panel. If the error persists, call a technician

F34	Error in photocell test (only for D-Pro Automatic R10)	Press the STOP button on the front panel to attempt a new photocell test. The control unit automatically clears the error as soon as the test is successful
F35	The difference between the upper and lower limit switch is less than 500 or greater than 8100 encoder increments	Contact a technician for encoder replacement
F60	Communication error with inverter (inverter error not read correctly)	Press the STOP button on the front panel. If the error persists, switch off the control unit and wait approximately one minute before switching it back on
F61	Communication error with inverter (inverter error reading not possible)	Press the STOP button on the front panel. If the error persists, switch off the control unit and wait approximately one minute before switching it back on
F100	Release cable input activation (Terminal X2-J10)	These errors clear automatically as soon as the control unit detects the safety chain is closed again
F101	Key release activation (Terminal X9-J14)	
F102	Emergency button activation ("Notaus" terminal)	
F103	Absence of boost capacitor control board (Terminal X8)	
F104	Motor thermal relay activation or manual release activation	

5.5 Nice inverter errors list

TABLE 19 B - Nice inverter errors list

Error	Description	Solution
F200	Short-circuit protection. The error will first appear as "E200" and then change to "F200" when it can be cleared	Press the STOP button on the front panel
F201	Overvoltage protection	Press the STOP button on the front panel
F202	Undervoltage protection	Press the STOP button on the front panel
F203	Over- or under-temperature protection	Press the STOP button on the front panel
F204	IGBT module overload protection (motor control) The error will first appear as "E204" and then change to "F204" when it can be cleared	Press the STOP button on the front panel
F205	Motor overload protection (current too high on phases; see parameter U24) The error will first appear as "E205" and then change to "F205" when it can be cleared	Press the STOP button on the front panel
F206	Error history (if U5 value > 29)	Reset U5 value by entering the parameter and holding down the STOP button on the front panel until the value returns to 0
F207	Software overcurrent protection	Press the STOP button on the front panel
F208	Protection from broken cables (missing motor phase)	Check the motor is correctly connected and/or a phase cable is not broken The control unit automatically clears the error as soon as the resistor is reconnected
F209	Protection for communication failure with D-Pro Automatic	Reboot the control unit
F210	Protection for communication failure with encoder	Reboot the control unit
F211	Short-circuit protection on IGBT module	Press the STOP button on the front panel
F212	IGBT module integrity protection	Press the STOP button on the front panel
F213	Braking resistor broken or not connected	Contact a technician

6. DISPOSING OF THE PRODUCT



The adjacent symbol affixed to the product indicates that it is considered as WEEE.

The abbreviation WEEE (Waste Electrical and Electronic Equipment) indicates that this product:

- at the end of its useful life must not be assimilated with other household waste but must be disposed of separately;
- contains mixed recyclable and non-recyclable materials;

As such, if you have to dispose of the product, it must be "collected separately" in accordance with the regulations in force in your area.

Warning! – Some parts of the product may contain polluting or dangerous substances. If not disposed of correctly, these substances may have a damaging effect on the environment and human health.

Warning! – Local regulations may impose heavy penalties if this product is not disposed of in compliance with the law.

Warning! As with the installation, only qualified personnel must dismantle the product at the end of its life.

7. PRODUCT SPECIFICATIONS

NOTES

- All of the technical specifications given refer to a temperature of 20°C (± 5°C).
- Nice reserves the right to make such changes to the product as are deemed necessary while maintaining its functionality and intended use.
- The complete use manual consists of the use instructions for the automation and the instructions for the control unit belonging to it.

Model	NDCC1000	NDCC1100	NDCC1200
Type	Control unit for three-phase motors	Control unit for inverter motors	Control unit for single-phase motors
Power voltage	3~400Vac (+10% -10%) 50/60Hz	1~230Vac (+10% -10%) 50/60Hz	1~230Vac (+10% -10%) 50/60Hz
Motor max. power	2.2kW	2.2kW	2.2kW
Consumption in standby	<5W		
Power board fuses	F1,F2,F3: 6.3A Type T	F1,F2,F3: 10A Type T	F1,F2,F3: 6.3A Type T
Logic board safety fuse	F4: 1A Type F		
Logic power voltage	24Vdc (with secondary protection F4)		
Output 1 (Relay 1)	Dry contact, programmable in parameter P112		
Output 2 (Relay 2)	Dry contact, programmable in parameter P111		
Output 3 (Relay 3)	Dry contact, programmable in parameter P110		
Services output	24Vdc (max. 800mA, resistive load) on connector X5 - J30 with removable terminal		
Safety edge	Resistive or pneumatic safety edge (selecting via "8k2" jumper) or OSE optical safety edge (selecting via "Opto" jumper), programmable in parameter P105		
UP input	For normally open contacts (NO), programmable in parameter P100		
DOWN input	For normally open contacts (NO), programmable in parameter P101		
IMP input	For normally open contacts (NO), programmable in parameter P102		
STOP input	For normally closed contacts (NC), safety circuit		
PRE LIMIT input	For normally open contacts (NO), programmable in parameter P103		
Photo input	For normally closed contacts (NC), programmable in parameter P104		
Radio connection	SM connector for compatible Nice receivers (Options programmable in parameter P106)		
Radio aerial input	52 ohm for RG58 cable or similar (max. 10m)		
Programmable functions	Functions programmable in programming mode with compatible interfaces		
Operating temperature	(-20 °C ÷ 50 °C)		
Use in particularly acidic, saline or potentially explosive atmospheres	No		
Protection rating	IP65		
Vibration	Swing-free mounting (e.g. on a masonry wall)		
Dimensions	310 x 210 x 125 mm		
Weight	3.5 kg		

EC Declaration of Conformity and declaration of incorporation as “partly completed machinery”

The EC Declaration of Conformity can be downloaded from our website www.niceforyou.com

Nice	D-Pro Automatic	
	NDCC1000	
Made in Italy	P/N: NDCC1000	
Nice SpA Via Callalta, 1 31046 Oderzo (TV) Italy		
2,2kW	3~400V	50Hz
-20°C		+50°C
WO	123456	
S/N:	0301232631803001I	
IP65		
	UK CA	

Nice	NDCC1100	
	NDCC1100	
Made in Italy	P/N: NDCC1100	
Nice SpA Via Callalta, 1 31046 Oderzo (TV) Italy		
2,2kW	1~230V	50Hz
-20°C		+50°C
WO	123456	
S/N:	030123263180302ZI	
IP65		
	UK CA	

Nice	D-Pro Automatic	
	NDCC1200	
Made in Italy	P/N: NDCC1200	
Nice SpA Via Callalta, 1 31046 Oderzo (TV) Italy		
2,2kW	1~230V	50Hz
-20°C		+50°C
WO	123456	
S/N:	0301232631803030I	
IP65		
	UK CA	



Nice SpA
Oderzo TV Italy
info@niceforyou.com

www.niceforyou.com