

ETHERNETS

Clause 4 Media Access Control (MAC) Test Suite Version 5.3

Technical Document



Last Updated: June 4, 2015

Ethernet Testing Services

<http://www.iol.unh.edu/10baset/>

Fast Ethernet Consortium

<http://www.iol.unh.edu/fe>

Gigabit Ethernet Consortium

<http://www.iol.unh.edu/ge>

10 Gigabit Ethernet Consortium

<http://www.iol.unh.edu/10gec>

*40 and 100 Gigabit Ethernet
Consortium*

<http://www.iol.unh.edu/40and100gec>

University of New Hampshire

121 Technology Drive, Suite 2

InterOperability Laboratory

Durham, NH 03824

Phone: +1-603-862-0090

MODIFICATION RECORD

- June 4, 2015 Version 5.3 Released
Peter Scruton: Clarified the document to reference latest standard (IEEE Std 802.3-2012). Removed the testing and checking of statistics. In addition, fixed typographical errors, revised various procedures, write-ups, and observable results.
- March 17, 2011 Version 5.2 Released
Dave Estes: Updated to include 40 and 100 Gigabit Ethernet MAC, along with minor editorial corrections
- February 4, 2011 Version 5.1 Released
Dave Estes: Updated to include 10 Gigabit Ethernet MAC
- January 28, 2011 Version 5.0 Released
Peter Scruton: Clarified the document to include 802.3as modifications (included in 802.3 2008), such as Envelope Frames and extensively revised the terms packet and frame to more consistently refer to packet as the encapsulation of a frame (802.3as defines a frame to include only the portion of a packet from just after the SFD until the end of the FCS field). A few additional test cases were added. In addition, fixed typographical errors, revised various procedures, write-ups, and observable results.
- February 3, 2006
Mike Henninger:
- January 26, 2005
Mike Henninger: Modified tests 4.1.3 and 4.1.4.
- January 13, 2005 Version 4.4 Released
Mike Henninger: Modified formatting, fix typographical error and modified tests dealing with length errors and padding.
- July 19, 2004 Version 4.3 Released
Pete Scruton: Fixed typographical errors, revised various procedures, write-ups, and observable results.
- June 23, 2004 Version 4.2 Released
Mike Henninger: Fix typographical error and expanded discussion in bursting and extension tests.
- July 8, 2003 Version 4.1 Released
Mike Henninger: Revised integrated test suite and add new tests
- October 10, 2001 Integrated Version 4.0 Released
Gerard Nadeau: Integrated all 10Mb/s, 100Mb/s and 1000Mb/s versions into one test suite.
- January 11, 2000 10BASE-T Version 3.0 Released
Neal Starr: Added missing tests from the Fast Ethernet test suite and renumbered test suite.
- January 10, 2000 Gigabit version 1.1 Released
Al Braga: Review test suite and update references to new version of the standard.
- October 13, 1999 10BASE-T Version 2.0 Released
Neal Starr: Added Start of Frame Delimiter Error Reception and Recovery.
- May 5, 1999 Fast Ethernet Version 3.10 Released
Pete Scruton: Fix typographical errors and renumbering tests.
- January 22, 1999 Fast Ethernet Version 3.01 Released
Pete Scruton: Major revision, rewritten and added tests.
- January 3, 1998 Gigabit Version 1.0 Released
Rupert Dance: Released initial version of the Gigabit MAC Test Suite.
- Date Unknown, Fast Ethernet Version 1.0 Released.
Bob Noseworthy: Released initial version of the Fast Ethernet Test Suite.
- Date Unknown, 10BASE-T Version 1.0 Released

*The University of New Hampshire
InterOperability Laboratory*

Adam Healey: Released initial version of the 10BASE-T Test Suite.

ACKNOWLEDGMENTS

The University of New Hampshire would like to acknowledge the efforts of the following individuals in the development of this test suite.

Aldobino Braga	University of New Hampshire
Cindy Bowman	University of New Hampshire
Rupert Dance	University of New Hampshire
Dave Estes	University of New Hampshire
Adam Healey	University of New Hampshire
Mike Henninger	University of New Hampshire
Stephen Kelsey	University of New Hampshire
Eric Lynskey	University of New Hampshire
Gerard Nadeau	University of New Hampshire
Bob Noseworthy	University of New Hampshire
Pooja Patel	University of New Hampshire
Peter Scruton	University of New Hampshire
Neal Starr	University of New Hampshire
David Strohschein	University of New Hampshire

INTRODUCTION

Overview

The University of New Hampshire's InterOperability Laboratory (IOL) is an institution designed to improve the interoperability of standards based products by providing an environment where a product can be tested against other implementations of a standard. This suite of tests has been developed to help implementers evaluate the functioning of their Clause 4 Media Access Control (MAC) based products. The tests do not determine if a product conforms to the IEEE 802.3, nor are they purely interoperability tests. Rather, they provide one method to isolate problems within a MAC device. In addition, a failure observed upon completion of the tests contained in this test suite may indicate a system implementation error and not a MAC error. Successful completion of all tests contained in this suite does not guarantee that the tested device will operate with other devices. However, combined with satisfactory operation in the IOL's interoperability test bed, these tests provide a reasonable level of confidence that the Device Under Test (DUT) will function well in most environments.

Organization of Tests

The tests contained in this document are organized to simplify the identification of information related to a test and to facilitate in the actual testing process. Each test contains an identification section that describes the test and provides cross-reference information. The discussion section covers background information and specifies why the test is to be performed. Tests are grouped by similar functions and further organized by technology. Each test contains the following information:

Test Number

The Test Number associated with each test follows a simple grouping structure. Listed first is the General Clause of the IEEE 802.3 standard that is under test, followed by the Test Group Number, followed by the test's number within the group. This allows for the addition of future tests to the appropriate groups of the test suite without requiring the renumbering of the subsequent tests.

Purpose

The purpose is a brief statement outlining what the test attempts to achieve. The test is written at the functional level.

References

The references section lists cross-references to the IEEE 802.3 standards and other documentation that might be helpful in understanding and evaluating the test and results.

Resource Requirements

The requirements section specifies the hardware, and test equipment that will be needed to perform the test. The items contained in this section are special test devices or other facilities, which may not be available on all devices.

Last Modification

This specifies the date of the last modification to this test.

Discussion

The discussion covers the assumptions made in the design or implementation of the test as well as known limitations. Other items specific to the test are covered here.

Test Setup

The University of New Hampshire
InterOperability Laboratory

The setup section describes the configuration of the test environment. Small changes in the configuration should be included in the test procedure.

Procedure

The procedure section of the test description contains the step-by-step instructions for carrying out the test. It provides a cookbook approach to testing, and may be interspersed with observable results.

Observable Results

The observable results section lists specific items that can be examined by the tester to verify that the DUT is operating properly. When multiple values are possible for an observable result, this section provides a short discussion on how to interpret them. The determination of a pass or fail for a certain test is often based on the successful (or unsuccessful) detection of a certain observable result.

Possible Problems

This section contains a description of known issues with the test procedure, which may affect test results in certain situations.

TABLE OF CONTENTS

MODIFICATION RECORD	ii
ACKNOWLEDGMENTS.....	iv
INTRODUCTION.....	v
TABLE OF CONTENTS.....	vii
LIST OF TABLES.....	ix
APPLICATION TABLE.....	x
GROUP 1: Errors During Reception.....	2
Test #4.1.1 - Reception of Frames with FCS errors	3
Test #4.1.2 - Reception of Fragments and Runts	5
Test #4.1.3 - Reception and Transmission of Oversized Frames	10
Test #4.1.4 - Reception of Frames with Length Errors.....	14
Test #4.1.5 - Receive Frames with Excess Pad.....	17
Test #4.1.6 - Jabber Frame Reception and Recovery.....	19
Test #4.1.7 - Start Frame Delimiter Error Reception and Recovery	22
Test #4.1.8 - Frames with Alignment Errors.....	24
Test #4.1.9 - Preamble Error Reception and Recovery	26
GROUP 2: Encapsulation and De-capsulation	28
Test #4.2.1 - Transmit Proper Preamble and SFD	29
Test #4.2.2 - Transmission of Minimum interPacketGap.....	31
Test #4.2.3 - Compute and Transmit Proper CRC	34
Test #4.2.4 - Receive Variable Preamble.....	35
Test #4.2.5 - Receive all Frame Sizes	38
Test #4.2.6 - Reception of Minimum interPacketGap.....	42
Test #4.2.7 - Compute and Transmit Proper Extension.....	44
Test #4.2.8 - Receive Packets with Extension.....	46
GROUP 3: Full Duplex.....	48
Test #4.3.1 - Does not Defer	49
Test #4.3.2 - No Collisions	51
Test #4.3.3 - No Extension.....	52
Test #4.3.4 - No Bursting.....	53
GROUP 4: Collision Behavior	55
Test #4.4.1 - Collisions During Preamble and SFD within slotTime.....	56
Test #4.4.2 - Collisions After the Reception of SFD within slotTime	58
Test #4.4.3 - Collisions in Data Outside of slotTime while not Bursting.....	60
Test #4.4.4 - Collisions During Extension within slotTime	62
Test #4.4.5 - Collisions During Preamble and SFD Outside of slotTime (Burst Mode).....	65
Test #4.4.6 - Collisions During Data Outside of slotTime (Burst Mode).....	68
Test #4.4.7 - Collisions During IPG within a Burst.....	71
GROUP 5: Deference Process	73
Test #4.5.1 - Defer to Carrier Sense while Frame Waiting	74
Test #4.5.2 - Deference After Collision	76

*The University of New Hampshire
InterOperability Laboratory*

Test #4.5.3 – InterPacketGapPart1 Timing	78
GROUP 6: Backoff.....	80
Test #4.6.1 - Retransmission Attempt Limit.....	81
Test #4.6.2 - Truncated Binary Exponential BackOff test	83
GROUP 7: Frame Bursting.....	85
Test #4.7.1 - Interpacket Fill	86
Test #4.7.2 - Burst limit	87
Test #4.7.3 - Receive Frame Bursts	90
Test #4.7.4 - Reception of Bursts with an Initial Frame Less than slotTime	92
ANNEX A (informative) Table of Acronym Definitions.....	94
ANNEX B (informative) Testing Requirements.....	97
ANNEX C (informative) Suggested Test Setups and Configurations.....	98
ANNEX D Stressing the device under test (DUT)	100

LIST OF TABLES

Table 4 - 1 Application of tests to given physical speeds.....	x
Table 4 - 2 Fragment and Runt Test Frames, Part A.....	6
Table 4 - 3 Values of 'm', 'n', 'y', and 'z' Part A.....	7
Table 4 - 4 Fragment and Runt Test Frames, Part B.....	8
Table 4 - 5 Fragments and Runts Observable Results, Part A.....	9
Table 4 - 6 Fragments and Runts Observable Results, Part B.....	9
Table 4 - 7 Jabber Frames	21
Table 4 - 8 Value of 'x' for test 4.2.5	25
Table 4 - 9 Acceptable Amounts of Preamble	37
Table 4 - 10 Value of 'n' for test 4.2.6.....	43
Table 4 - 11 Values of "n" for test 4.1.1	57
Table 4 - 12 Values of 'n' for test 4.1.2.....	59
Table 4 - 13 Initial value for "n" for test 4.4.3	61
Table 4 - 14 Values for Test 4.5.1	74
Table 4 - 15 Values of 'n' and 'x' for Test 4.5.2	76
Table 4 - 16 Values for InterPacketGapPart1 Timing Test.....	79
Table 4 - 17 Receive Packet Bursts.....	91
Table 4 - 18 Interpretation of Burst Reception Results	91
Table 4 - 19 Reception of Bursts with an initial frame less than slotTime.....	93
Table 4 - 20 Interpretation of Burst Error Reception Results	93
Table 4 - 21 Acronym Definitions.....	94

APPLICATION TABLE

The following table denotes whether or not the listed test is applicable to the given physical layer speed.

Table 4 - 1 Application of tests to given physical speeds

Group 1 - Errors during Reception	10Mb/s	100Mb/s	1000Mb/s	10,000Mb/s 40,000Mb/s 100,000Mb/s
Test #4.1.1 - Reception of Frames with FCS errors	√	√	√	√
Test #4.1.2 - Reception of Fragments and Runts	√	√	√	√
Test #4.1.3 - Reception and Transmission of Oversized Frames	√	√	√	√
Test #4.1.4 - Reception of Frames with Length Errors	√	√	√	√
Test #4.1.5 - Receive Frames with Excess Pad	√	√	√	√
Test #4.1.6 - Jabber Frame Reception and Recovery	√	√	√	√
Test #4.1.7 - Start Frame Delimiter Error Reception and Recovery	√	√	√	√
Test #4.1.8 - Frames with Alignment Errors	√	√		
Test #4.1.9 - Preamble Error Reception and Recovery		√	√	√
Group 2 - Encapsulation and De-capsulation				
Test #4.2.1 - Transmit Proper Preamble and SFD	√	√	√	√
Test #4.2.2 - Transmission of Minimum interPacketGap	√	√	√	√
Test #4.2.3 - Compute and Transmit Proper CRC	√	√	√	√
Test #4.2.4 - Receive Variable Preamble	√	√	√	√
Test #4.2.5 - Receive all Frame Sizes	√	√	√	√
Test #4.2.6 - Reception of Minimum interPacketGap	√	√	√	√
Test #4.2.7 - Compute and Transmit Proper Extension			√	
Test #4.2.8 - Receive Packets with Extension			√	
Group 3 - Full Duplex				
Test #4.3.1 - Does not Defer	√	√	√	
Test #4.3.2 - No Collisions	√	√	√	
Test #4.3.3 - No Extension			√	
Test #4.3.4 - No Bursting			√	
Group 4 - Collision behavior				
Test #4.4.1 - Collisions During Preamble and SFD within slotTime.	√	√	√	
Test #4.4.2 - Collisions After the Reception of SFD within slotTime	√	√	√	
Test #4.4.3 - Collisions in Data Outside of slotTime while not Bursting	√	√	√	
Test #4.4.4 - Collisions During Extension within slotTime			√	

*The University of New Hampshire
InterOperability Laboratory*

Test #4.4.5 - Collisions During Preamble and SFD Outside of slotTime (Burst Mode).			√	
Test #4.4.6 - Collisions During Data Outside of slotTime (Burst Mode)			√	
Test #4.4.7 - Collisions During IPG within a Burst			√	
Group 5 - Deference Process				
Test #4.5.1 - Defer to Carrier Sense while Frame Waiting	√	√	√	
Test #4.5.2 - Deference After Collision	√	√	√	
Test #4.5.3 – InterPacketGapPart1 Timing	√	√	√	
Group 6 - Backoff				
Test #4.6.1 - Retransmission Attempt Limit	√	√	√	
Test #4.6.2 - Truncated Binary Exponential BackOff test	√	√	√	
Group 7 - Packet Bursting				
Test #4.7.1 - Interpacket Fill			√	
Test #4.7.2 - Burst limit			√	
Test #4.7.3 - Receive Frame Bursts			√	
Test #4.7.4 - Reception of Bursts with an Initial Frame Less than slotTime			√	

GROUP 1: Errors During Reception

Scope: The following tests cover MAC operations specific to reception of packets with errors.

Overview: These tests are designed to verify that the device under test properly discards packets with errors and reports these errors if possible. The MAC functions explored are defined in Clause 4 of IEEE 802.3.

The University of New Hampshire
InterOperability Laboratory

Test #4.1.1 - Reception of Frames with FCS errors

Purpose: To verify that the device under test (DUT) discards frames with frame check sequence (FCS) errors and that they do not interfere with the reception of valid frames.

References:

- [1] IEEE Std 802.3-2012, subclause 3.2.9 - Frame Check Sequence (FCS) field
- [2] IEEE Std 802.3-2012, subclause 3.4 - Invalid MAC frame
- [3] IEEE Std 802.3-2012, subclause 4.2.4.1.2 - Frame check sequence validation
- [4] IEEE Std 802.3-2012, subclause 4.2.9 - Frame reception
- [5] ANNEX A (informative) Table of Acronym Definitions
- [6] ANNEX B (informative) Testing Requirements
- [7] ANNEX C (informative) Suggested Test Setups and Configurations

Resource Requirements: A testing station capable of transmitting frames with arbitrary values in the FCS field and capable of monitoring traffic from the DUT.

Last Modification: April 8, 2015

Discussion: A CRC is used by transmit and receive algorithms to detect any errors generated during the transmission of the frame. The FCS field contains a 4-octet (32-bit) CRC value generated by the transmit algorithm. This value is computed as a function of the contents of the destination address, source address, length/type, LLC data and pad fields (that is, all fields except the preamble, SFD, and FCS). The receiving MAC sublayer collects bits from the reconciliation layer or the PLS layer. One of the receiving MAC sublayer's functions is to check for invalid MAC frames by checking the Frame Check Sequence (FCS) field, which is done regardless of the value of passReceiveFCSMode. It does so by computing the 32-bit CRC of the received frame and comparing it to the received 32-bit CRC in the FCS field. In the case of a mismatch, it should reject the frame.

Test Setup: Connect the device under test (DUT) to the testing station with the appropriate medium (i.e. unshielded twisted pair (UTP), shielded twisted pair (STP), balanced copper, multi-mode fiber, etc.) and transmit a valid frame to the DUT to ensure that the DUT is functioning properly. See [Annex C](#) for suggested test configurations.

Procedure:

Part A:

1. The testing station is instructed to transmit a frame with an incorrect 32-bit CRC value in the FCS field. The output of the DUT is observed.

Part B:

1. The testing station is instructed to transmit a frame with an incorrect 32-bit CRC value in the FCS field. This packet should be preceded and followed by a valid packet separated by minimum interPacketGap. The output of the DUT is observed.

Observable results:

- a. The DUT shall detect and discard the frame with an invalid value in the FCS field.
- b. The reception of test frames with invalid FCS fields should not affect the reception of the valid request frames.

Possible Problems: None

*The University of New Hampshire
InterOperability Laboratory*

*The University of New Hampshire
InterOperability Laboratory*

Test #4.1.2 - Reception of Fragments and Runts

Purpose: To verify that the device under test (DUT) discards undersized frames and fragments.

References:

- [1] IEEE Std 802.3-2012, subclause 4.2.4.2.2 - Collision filtering
- [2] IEEE Std 802.3-2012, subclause 4.2.9 – process BitReceiver
- [3] IEEE Std 802.3-2012, subclause 4.2.9 – process setExtending
- [4] IEEE Std 802.3-2012, subclause 4.2.9 – *procedure* ReceiveLinkMgmt
- [5] IEEE Std 802.3-2012, *process* BitReceiver
- [6] IEEE Std 802.3-2012, *process* SetExtending,
- [7] IEEE Std 802.3-2012, *procedure* ReceiveLinkMgmt
- [8] [ANNEX A \(informative\) Table of Acronym Definitions](#)
- [9] [ANNEX B \(informative\) Testing Requirements](#)
- [10] [ANNEX C \(informative\) Suggested Test Setups and Configurations](#)

Resource Requirements: A testing station capable of transmitting fragments and capable of monitoring traffic from the DUT.

Last Modification: May 11, 2015

Discussion: At speeds less than or equal to 100Mb/s in half duplex mode, frames less than 64 bytes in length are presumed to be collision fragments. At 1000Mb/s, in half-duplex and non-burst mode, a frame less than 512 bytes in length is considered to be a fragment and, in half-duplex and burst mode, the first frame must be at least 512 bytes and following frames must be at least 64 bytes.

The MAC should discard all such undersized frames and fragments. Since occasional collisions are a normal part of Media Access management procedure in half duplex mode, the discarding of such a fragment is not reported as an error.

A “runt” refers to a frame that has a valid 32-bit CRC value but is less than the minFrameSize for 10Mb/s half or full duplex, 100Mb/s half or full duplex, 1000Mb/s full duplex, 10000Mb/s full duplex, 40000Mb/s full duplex, and 100000Mb/s full duplex mode, or slotTime for 1000Mb/s in half duplex mode. The MAC layer should detect and discard runts because they are less than minFrameSize in length. This discarding should not be reported as an error.

Test Setup: Connect the device under test (DUT) to the testing station with the appropriate medium (i.e. unshielded twisted pair (UTP), shielded twisted pair (STP), balanced copper, multi-mode fiber, etc.) and transmit a valid frame to the DUT to ensure that the DUT is functioning properly. See [Annex C](#) for suggested test configurations.

*The University of New Hampshire
InterOperability Laboratory*

Procedure:

Part A:

1. The testing station is instructed to transmit Test Frame 1, given in Table 4 - 2, with current length of 'm', which has the initial value as described in Table 4 - 3. The output of the DUT is observed.
2. Ideally, step 1 should be repeated for Test Frames 1 through 4, given in Table 4 - 2, with all values of 'm', 'n', 'y', and 'z' as indicated in Table 4 - 3.

Table 4 - 2 Fragment and Runt Test Frames, Part A

	10/100 Mb/s	1000 Mb/s	10,000 40,000 100,000 Mb/s	Description
1	√	√	√	A fragment 'm' nibbles in length, with initial value of 'm' as indicated in Table 4-3, so the first fragment only has 'm' nibbles of preamble and no SFD, as 'm' increases it steps through the entire packet until it reaches a fragment that would be one nibble (or byte) short of a frame that is slotTime bytes long. The last 4 bytes of this fragment should not contain a valid CRC. Each time the size of the fragment is increased it is increased to a value that is a multiple of the "Minimum Increment Values" listed in Table 4-3.
2	√	√	√	A runt frame 'n' bytes in length, preceded by a valid preamble and SFD. The last 4 bytes of the undersized frame should contain a valid CRC.
3		√		A fragment 'y' bytes in length followed by extension. Extension should begin after the 'y' bytes of the fragment and should continue for (520-'y') bytes. 'y' has the initial value of 1 such that the first fragment only has one byte of preamble and no SFD followed by 519 bytes of extension, as 'y' increases it steps through the entire packet until it reaches 'y'=519 (which would be a fragment that would be one byte short of a valid 512-byte packet) and has one byte of extension (520-'y'). The last 4 bytes of the undersized fragment before the extension should not contain a valid CRC.
4		√		A runt frame 'z' bytes in length, preceded by a valid preamble and SFD followed by (512-'z') bytes of extension. 'z' has the initial value of 5, and a maximum value of 63. The last 4 bytes of the undersized frame before the extension should contain a valid CRC.

*The University of New Hampshire
InterOperability Laboratory*

Table 4 - 3 Values of 'm', 'n', 'y', and 'z' Part A

PHY SPEED/Duplex	Initial values	Minimum Increment Values	Maximum Values
≤ 10Mb/s, 100Mb/s	'm' = 2 nibbles 'n' = 5 bytes	'm' = 1 nibble 'n' = 1 byte	'm' = 143 nibbles 'n' = 63 bytes
1000BASE-T Full	'm' = 4 nibbles 'n' = 5 bytes 'y' = 1 byte 'z' = 5 bytes	'm' = 2 nibbles (one byte) 'n' = 1 byte 'y' = 1 byte 'z' = 1 byte	'm' = 142 nibbles (71 bytes) 'n' = 63 bytes 'y' = 71 bytes 'z' = 63 bytes
1000BASE-T Half	'm' = 4 nibbles 'n' = 5 bytes 'y' = 1 byte 'z' = 5 bytes	'm' = 2 nibbles (one byte) 'n' = 1 byte 'y' = 1 byte 'z' = 1 byte	'm' = 1022 nibbles (511 bytes) 'n' = 511 bytes 'y' = 511 bytes 'z' = 63 bytes
1000BASE-X Full	'm' = 2 nibbles 'n' = 5 bytes 'y' = 1 byte 'z' = 5 bytes	'm' = 2 nibbles (one byte) 'n' = 1 byte 'y' = 1 byte 'z' = 1 byte	'm' = 142 nibbles (71 bytes) 'n' = 63 bytes 'y' = 71 bytes 'z' = 63 bytes
1000BASE-X Half	'm' = 2 nibbles 'n' = 5 bytes 'y' = 1 byte 'z' = 5 bytes	'm' = 2 nibbles (one byte) 'n' = 1 byte 'y' = 1 byte 'z' = 1 byte	'm' = 1022 nibbles (511 bytes) 'n' = 511 bytes 'y' = 511 bytes 'z' = 63 bytes
10,000Mb/s,	'm' = 2 nibbles 'n' = 5 bytes	'm' = 2 nibble (one byte) 'n' = 1 byte	'm' = 142 nibbles 'n' = 63 bytes
40,000Mb/s, 100,000Mb/s	'm' = 16 nibbles 'n' = 5 bytes	'm' = 2 nibble (one byte) 'n' = 1 byte	'm' = 142 nibbles 'n' = 63 bytes

*The University of New Hampshire
InterOperability Laboratory*

Part B:

1. The testing station is instructed to transmit Test Frame 5 to the DUT. The output of the DUT is observed.
2. Step 1 is repeated for each of the applicable Test Frames 5 through 12.

Table 4 - 4 Fragment and Runt Test Frames, Part B

	10/100/10000Mb/s	40000/100000Mb/s	1000Mb/s	Description
5	√		√	7 octets of preamble
6	√	√	√	7 octets of preamble and SFD
7	√	√	√	7 octets of preamble, SFD and the MAC destination address of the DUT
8	√	√	√	7 octets of preamble, SFD, the MAC destination address of the DUT, and an arbitrary source address
9			√	6 octets of preamble, SFD, and a 511 byte runt
10			√	A packet burst, consisting of a properly encapsulated valid 512 byte request frame, 12 bytes of extension (IPG), a 42 byte runt, 12 bytes of extension (IPG), and a valid 64 byte request frame.
11			√	A packet burst, consisting of a 42-byte runt, 12 bytes of extension (IPG) and a 511-byte frame. This combination satisfies slotTime.*
12			√	A packet, consisting of a properly encapsulated, 64 byte request frame with valid checksums and 32-bit CRC fields, extended to 511 bytes.

*These test frames are only valid in Full Duplex mode.

Part C:

1. If the DUT supports Flow Control then cause the DUT to enter a mode in which the reception of PAUSE frames is enabled. Send a 63-Byte PAUSE frame and observe if this frame is accepted and causes the DUT to pause the transmission of frames. The output of the DUT is observed.

Part D:

1. Repeat *Parts A, B, and C* with each test packet preceded and followed by a valid packet, separated by a minimum interPacketGap. The output of the DUT is observed.

Observable Results:

The DUT should process each test frame as indicated in Table 4 - 5 and Table 4 - 6. The reception of the test packets should not affect the reception of the valid frames.

*The University of New Hampshire
InterOperability Laboratory*

Part A:

Table 4 - 5 Fragments and Runts Observable Results, Part A

Test Frame	10/100/10,000Mb/s	1000Mb/s		40,000Mb/s 100,000Mb/s
		Half Duplex	Full Duplex	Full Duplex
1	Discard	Discard	Discard	Discard
2	Discard	Discard	Discard	Discard
3	N/A	Discard	Discard	N/A
4	N/A	Discard ¹	Discard	N/A

Note 1: A 511 byte runt with 8 bytes of combined preamble and SFD will be accepted by a 1000BASE-X device due to the nature of the EPD (/T/R/R/) which is also considered part of carrier extension.

Part B:

Table 4 - 6 Fragments and Runts Observable Results, Part B

Test Frame	10/100/10,000Mb/s	1000Mb/s		40,000Mb/s 100,000Mb/s
		Half Duplex	Full Duplex	Full Duplex
5	Discard	Discard	Discard	N/A
6	Discard	Discard	Discard	Discard
7	Discard	Discard	Discard	Discard
8	Discard	Discard	Discard	Discard
9	N/A	Discard	Accept	N/A
10	N/A	Discard the 42-byte frame. Accept all others.	Discard 42-byte frame. Accept all others.	N/A
11	N/A	Discard both frames	Discard the 42-byte runt. Accept 511-byte frame	N/A
12	N/A	Discard	Accept	N/A

Part C:

1. The DUT should discard the PAUSE frame and furthermore it should not pause the transmission of frames based on the reception of this invalid frame.

Part D:

1. The reception of test frames should not affect the reception of the valid frames.

Possible Problems:

If the DUT is an End station it may be difficult to test undersized runt frames less than 42 bytes in length as these frames may not contain enough protocol information to be responded to as Echo Request Frames.

If the DUT implements a 10GBASE-R PCS the smallest fragment that can be tested is 4 bytes of preamble.

The University of New Hampshire
InterOperability Laboratory

Test #4.1.3 - Reception and Transmission of Oversized Frames

Purpose: To verify that the device under test (DUT) is tolerant of frames greater than maxFrameSize and that the DUT does not transmit frames greater than the maximum permitted frame size.

References:

- [1] IEEE Std 802.3-2012, subclause 3.2 - Elements of the MAC frame and packet
- [2] IEEE Std 802.3-2012, subclause 4.2.4.2.1 - Framing
- [3] IEEE Std 802.3-2012, subclause 4.2.7.1 - Common constants, types, and variables
- [4] IEEE Std 802.3-2012, subclause 4.2.9 - Frame reception
- [5] IEEE Std 802.3-2012, subclause 4.4.2 - MAC parameters
- [6] ANNEX A (informative) Table of Acronym Definitions
- [7] ANNEX B (informative) Testing Requirements
- [8] ANNEX C (informative) Suggested Test Setups and Configurations

Resource Requirements: A testing station capable of transmitting frames greater than maximum permitted frame size and capable of monitoring traffic from the DUT.

Last Modification: April 28, 2015

Discussion: According to IEEE 802.3 2012 section 3.2.7 implementations shall support at least one of three maximum MAC Client Data field sizes, 1500 for basic frames, 1504 for Q-tagged frames, and 1982 envelope frames. This would result in frame sizes of 1518, 1522, and 2000 bytes respectively.

In IEEE 802.3-2012, Section 3.2.7, NOTE 2 states “All IEEE 802.3 MAC frames share a common format. The processing of the three types of MAC frames is not differentiated within the IEEE 802.3 MAC, except for management. However, they may be distinguished within the MAC client.”

As specified in 4.2.4.2.1, enforcement of the frame size limit by the receiving device is not required. The receiving device is allowed to truncate frames longer than maxFrameSizeLimit and report this event as an implementation dependant error. maxFrameSizeLimit is specified to be either 1518, 1522, or 2000 bytes in length. If a frame is greater than the maximum permitted frame size (maxFrameSizeLimit) then *exceedsMaxLength* will be set to true in the *function* PhysicalSignalDecap and the FCS value should not be checked. This can be checked, if a device transmits an oversized frame or multiple frames (indicating that more than maxFrameSizeLimit worth of data was accepted) in response to the reception of an oversized frame simply by sending that device an oversized frame with an invalid CRC value in the FCS field. All oversized frames, both those with FCS errors and those without, should be handled in the same way.

Test Setup: Connect the device under test (DUT) to the testing station with the appropriate medium (i.e. unshielded twisted pair (UTP), shielded twisted pair (STP), balanced copper, multi-mode fiber, etc.) and transmit a valid frame to the DUT to ensure that the DUT is functioning properly. See [Annex C](#) for suggested test configurations.

Procedure:

Part A:

1. The testing station is instructed to transmit an untagged frame (Figure 4 - 1) with ‘n’ equal to 0.
2. Ideally the testing station is instructed to increment ‘n’ by 1 and retransmit the frame until the DUT is observed to discard or truncate the test frame. Typically several values will be chosen in an attempt to determine the maximum frame size accepted by the DUT.

*The University of New Hampshire
InterOperability Laboratory*

3. If the DUT accepts any frame of size $1518 + 'n'$ while discarding the frame of size $1518 + 'n+1'$ where the length $1518 + 'n'$ is not 1518, 1522, or 2000, then retransmit to the DUT the oversized frame of size $1518 + 'n'$ with an invalid CRC value. If it then accepts both determine the minimum frame size where it will still accept both.



Figure 4 - 1 Untagged frame

Part B:

1. The testing station is instructed to transmit a tagged frame (Figure 4 - 2) with 'n' equal to 0.
2. Ideally the testing station is instructed to increment 'n' by 1 and retransmit the frame until the DUT is observed to discard or truncate the test frame. Typically several values will be chosen in an attempt to determine the maximum frame size accepted by the DUT.
3. If the DUT accepts any frame of size $1518 + 'n'$ while discarding the frame of size $1518 + 'n+1'$ where $1518 + 'n'$ is not 1518, 1522, or 2000, then retransmit the oversized frame of size $1518 + 'n'$ with an invalid CRC value. If it then accepts both determine the minimum frame size where it will still accept both.

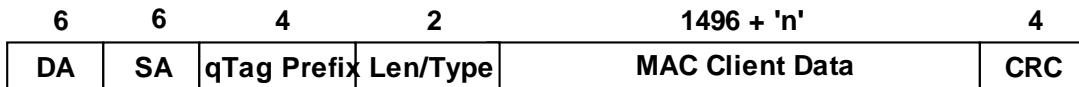

Figure 4 - 2 Tagged frame

Part C:

1. The testing station is instructed to transmit an oversized envelope frame (Figure 4 - 3) with 'n' equal to 0.
2. Ideally the testing station is instructed to increment 'n' by 1 and retransmit the frame until the DUT is observed to discard or truncate the test frame. Typically several values will be chosen in an attempt to determine the maximum frame size accepted by the DUT.
3. If the DUT accepts any frame of size $1518 + 'n'$ while discarding the frame of size $1518 + 'n+1'$ where $1518 + 'n'$ is not 1518, 1522, or 2000, then retransmit the oversized frame of size $1518 + 'n'$ with an invalid CRC value. If it then accepts both determine the minimum frame size where it will still accept both.



Figure 4 - 3 Envelope frame

Part D:

1. If the DUT supports Flow Control then cause the DUT to enter a mode in which the reception of PAUSE frames is enabled. Send an oversized PAUSE frame (Figure 4-4) with 'n' equal to 0. Observe if this frame is accepted and causes the DUT to pause the transmission of frames.
2. If the DUT was observed to pause the transmission of frames, increment the size of the PAUSE frame by 1 byte and repeat step 1 until the DUT does not pause the transmission of frames.

*The University of New Hampshire
InterOperability Laboratory*

3. If the maximum length PAUSE frame that causes the DUT to pause is not 1518, 1522, or 2000 bytes, send a PAUSE frame of maximum length with an invalid CRC value.

6	6	6	1496 +	4
Multicast¹	SA	88-08-00-01-(FF-FF)	Reserved (all 0's)	CRC

Note 1: This is the reserved PAUSE multicast (01-80-C2-00-00-01)

Note 2: This is the Pause time and can be set to any value sufficient to observe the effects of the PAUSE

Figure 4 - 4 PAUSE frame

Part E:

1. *Parts A through C* are repeated with the test frame preceded and followed by a valid frame, each separated by a minimum interPacketGap (96 bit-times).

*The University of New Hampshire
InterOperability Laboratory*

Observable Results:

- a. The DUT may discard any untagged frame larger than the `maxUntaggedFrameSize` of 1518 bytes. The limit for received MAC frames should be 1518, 1522, or 2000. In addition, if the DUT accepts a frame exceeding 2000 bytes, the CRC value should not be checked, thus oversized frames with CRC errors should be handled in an identical fashion as oversized frames with valid CRC values. In addition, if the DUT was observed to accept both the frame with the valid and the frame with the invalid CRC further investigate the frame size at which this behavior starts. It must start at size 1519, 1523, or 2001 and must also be the same as found in all frame types.
- b. The DUT may discard any tagged frame larger than the `maxUntaggedFramesSize` and the `qTagPrefixSize` combined (1522 bytes). The limit for received MAC frames should be 1518, 1522, or 2000. In addition, if the DUT accepts a frame exceeding 2000 bytes, the CRC value should not be checked, thus oversized frames with CRC errors should be handled in an identical fashion as oversized frames with valid CRC values. In addition, if the DUT was observed to accept both the frame with the valid and the frame with the invalid CRC further investigate the frame size at which this behavior starts. It must start at size 1519, 1523, or 2001 and must also be the same as found in all frame types
- c. The DUT should discard any frame, including envelope frames, exceeding 2000 bytes in length. The limit for received MAC frames should be 1518, 1522, or 2000. In addition, if the DUT accepts a frame exceeding 2000 bytes, the CRC value should not be checked, thus oversized frames with CRC errors should be handled in an identical fashion as oversized frames with valid CRC values. In addition, if the DUT was observed to accept both the frame with the valid and the frame with the invalid CRC further investigate the frame size at which this behavior starts. It must start at size 1519, 1523, or 2001 and must also be the same as found in all frame types.
- d. MAC Control frames are specified to be 64 bytes in length. If the DUT chooses to truncate and accept MAC Control frames greater than 64 bytes in length, this acceptance should occur for frames up to and including `maxFrameSizeLimit`. The limit for received MAC Control frames should be 1518, 1522, or 2000 and should be the same as found for the other frame types. In addition, if the DUT accepts a frame exceeding 2000 bytes, the CRC value should not be checked, thus oversized frames with CRC errors should be handled in an identical fashion as oversized frames with valid CRC values. In addition, if the DUT was observed to accept both the frame with the valid and the frame with the invalid CRC further investigate the frame size at which this behavior starts. It must start at size 1519, 1523, or 2001 and must also be the same as found in all frame types.
- e. The reception of test frames should not affect the reception of valid frames preceding or following the test frame.

Possible Problems:

- If the DUT supports a proprietary frame size (Jumbo frames) greater than the maximum permitted frame size, it should be disabled before this test is performed.
- As differentiation between the different types of frames (basic, tagged, and envelope) is not distinguished at the MAC but may be distinguished by the MAC Client it may not be possible to determine the maximum frame size accepted by the MAC, as the MAC Client may discard it. As a result it may be difficult to determine what this value is at the MAC if it is more than 1518 but less than 2000 bytes in length.

Test #4.1.4 - Reception of Frames with Length Errors

Purpose: To verify that the device under test (DUT) detects and discards frames with length errors.

References:

- [1] IEEE Std 802.3-2012, subclause 3.2.6 - Length/Type field
- [2] IEEE Std 802.3-2012, subclause 3.2.7 - MAC Client Data field
- [3] IEEE Std 802.3-2012, subclause 3.4 - Invalid MAC frame
- [4] IEEE Std 802.3-2012, subclause 4.3.2 - MAC service
- [5] IEEE Std 802.3-2012, subclause 4.2.8 - Frame transmission
- [6] IEEE Std 802.3-2012, subclause 4.2.9 - Frame reception
- [7] IEEE Std 802.3-2012, subclause 31.5 - Opcode-independent MAC Control sublayer operation
- [8] [ANNEX A \(informative\) Table of Acronym Definitions](#)
- [9] [ANNEX B \(informative\) Testing Requirements](#)
- [10] [ANNEX C \(informative\) Suggested Test Setups and Configurations](#)

Resource Requirements: A testing station capable of transmitting frames with invalid length values in the length/type field and capable of monitoring traffic from the DUT.

Last Modification: April 28, 2015

Discussion: When receiving a frame, the MAC layer of the receiving station interprets the value of the 2-octet long Length/Type field of the frame. If the value in the Length/Type field is greater than or equal to 1536 then the value indicates the type of the frame, or if the value in the field is less than or equal to 1500 then the value indicates the length of the frame. All other values are undefined.

If the value in the Length/Type field indicates a length but the length indicated is less than the minimum required for proper operation of the protocol (46 bytes), then Pad will be added at the end of the Data/Pad field but prior to the FCS field.

When the MAC sublayer receives a frame, the *function* ReceiveDataDecap verifies that the length matches the length of the data field. If the length indicated in the Length/Type field is less than the length of the data field, the extra is assumed to be pad and removed. If the length indicated in the Length/Type field is greater than the length of the data field, then the frame is identified as having a length error. In addition, subclause 3.4 indicates that frames with length value inconsistent with the length of the frame should not be passed up the LLC or the MAC Control layer (all other MAC Clients are outside the scope of this test suite), thus all frames with length errors should be discarded.

Test Setup: Connect the device under test (DUT) to the testing station with the appropriate medium (i.e. unshielded twisted pair (UTP), shielded twisted pair (STP), balanced copper, multi-mode fiber, etc.) and transmit a valid frame with an appropriate length in the Length/Type field to the DUT to ensure that the DUT is functioning properly. See [Annex C](#) for suggested test configurations.

Procedure:

Part A:

1. The testing station is instructed to transmit a 64-byte frame with the value of 0x002F in the length field; this value is the length of the Data/Pad field plus one.
2. The value in the Length/Type field is then incremented by 1 and the test frame is retransmitted until the value is equal to 0x05FF.

*The University of New Hampshire
InterOperability Laboratory*

3. Once the value in the Length/Type field is equal to 0x05FF then the size of the frame is incremented by 1 and the value of the Length/Type field is set to the length of the Data/Pad field plus one. The test frame is then retransmitted.
4. Ideally, steps 2 and 3 are repeated until frame size is equal to 1518 bytes in length. Typically, 2 or 3 lengths are tested for 2 or 3 different frame sizes.

Part B:

1. *Part A* is repeated with the test frames preceded and followed by a valid frame, separated by minimum interPacketGap (96 bit-times).

*The University of New Hampshire
InterOperability Laboratory*

Observable results:

- a. Frames with length values greater than the length of Data/Pad field should be considered to have invalid length values and that they should be discarded by the DUT. It is undefined how frames with values ranging from 0x05DD to less than 0x5FF should be handled.
- b. The reception of test frames should not affect the reception of the valid request frames (including frames with undefined values in the Length/Type field).

Possible Problems:

- If the DUT does not implement an LLC or a MAC Control layer “invalid MAC frames may be ignored, discarded or used in a private manner.” Any such implementation is beyond the scope of the 802.3 standard and is not tested.

The University of New Hampshire
InterOperability Laboratory

Test #4.1.5 - Receive Frames with Excess Pad

Purpose: To verify that the device under test (DUT) accepts frames that are greater than minimum frame size in length and which contain pad.

References:

- [1] IEEE Std 802.3-2012, subclause 3.2.6 - Length/Type field
- [2] IEEE Std 802.3-2012, subclause 3.2.7 - MAC Client Data field
- [3] IEEE Std 802.3-2012, subclause 4.3.2 - MAC service
- [4] IEEE Std 802.3-2012, subclause 4.2.8 - Frame transmission
- [5] IEEE Std 802.3-2012, subclause 4.2.9 - Frame reception Interpretation of IEEE Std 802.3-2002- Interpretation Number 03-11/04
- [6] [ANNEX A \(informative\) Table of Acronym Definitions](#)
- [7] [ANNEX B \(informative\) Testing Requirements](#)
- [8] [ANNEX C \(informative\) Suggested Test Setups and Configurations](#)

Resource Requirements: A testing station capable of transmitting frames with excess pad and capable of monitoring traffic from the DUT.

Last Modification: April 28, 2015

Discussion: When receiving a frame, the MAC layer of the receiving station interprets the value of the 2-octet long Length/Type field of the frame. If the value in the Length/Type field is greater than or equal to 1536 then the value indicates the type of the frame, or if the value in the field is less than or equal to 1500 then the value indicates the length of the frame. All other values are undefined.

If the value in the Length/Type field indicates a length but the length indicated is less than the minimum required for proper operation of the protocol (46 bytes), then the transmit MAC will add a PAD field at the end of the Data/Pad field but prior to the FCS field. The PAD field should make the total length of the frame minFrameSize in length (512 bit times).

It has been demonstrated that some devices improperly add pad to frames that contain data greater than the minimum required for proper operation of the protocol. IEEE 802.3 does not define how these frames should be handled, so how these frames are handled is at the discretion of the implementer. It should be noted that these frames may have valid CRC values and valid data so discarding them may cause unnecessary frames loss.

The reception of frames with excess pad should not interfere with the reception of valid frames.

Test Setup: Connect the device under test (DUT) to the testing station with the appropriate medium (i.e. unshielded twisted pair (UTP), shielded twisted pair (STP), balanced copper, multi-mode fiber, etc.) and transmit a valid frame to the DUT to ensure that the DUT is functioning properly. See [Annex C](#) for suggested test configurations.

Procedure:

Part A:

1. The testing station is instructed to transmit a 65 byte frame with the value of 0x2E in the length/type field, thus the frame will contain 46 bytes of data and 1 byte of pad.
2. The length of the frame incremented by one and the test frame is retransmitted until the length of the frame is equal to 1518 bytes in length.

The University of New Hampshire
InterOperability Laboratory

3. Once the frame is equal to 1518 bytes in length the value of Length/Type field is incremented by one and the length of the Data/Pad is set equal to the value in the Length/Type plus one. The test frame is retransmitted.
4. Ideally, steps 1 through 3 are repeated such that each possible length value is tested for each possible frame size. Typically, a few length values are tested for a few different frame sizes.

Part B:

1. *Part A* is repeated with the test frames preceded and followed by a valid frame, each separated by a minimum interPacketGap (96 bit times).

Observable results:

- a. The standard is ambiguous on how a frame with excess padding should be handled, thus this test part is performed on an informative basis only. As the frames with excess padding used in this test are valid in all other respects, the UNH-IOL recommends that the DUT accept each test frame and reply with a frame that does not contain padding. This ensures that the valid data is not discarded.
- b. The reception of test frames should not affect the reception of the valid request frames.

Possible Problems: None

*The University of New Hampshire
InterOperability Laboratory*

Test #4.1.6 - Jabber Frame Reception and Recovery

Purpose: To verify that the device under test (DUT) is able to withstand and recover from the reception of worst-case jabber transmissions.

References:

- [1] IEEE Std 802.3-2012, subclause 4.2.4.2.1 - Framing
- [2] IEEE Std 802.3-2012, subclause 4.2.9 - Frame reception
- [3] IEEE Std 802.3-2012, subclause 4.4.2 - MAC parameters
 - (a) 10Mb/s: - 9.6.5 - MAU Jabber Lockup Protection, 14.2.1.6 - Jabber function requirements
 - (b) 100BASE-X: - 27.3.2.1.4 - Timers, Figure 27-7 Receive timer state diagram for port X
 - (c) 1000BASE-X: - 41.2.2.1.4 - Timers, Figure 41-3 Receive timer state diagram for port X
- [4] [ANNEX A \(informative\) Table of Acronym Definitions](#)
- [5] [ANNEX B \(informative\) Testing Requirements](#)
- [6] [ANNEX C \(informative\) Suggested Test Setups and Configurations](#)

Resource Requirements: A testing station capable of transmitting extremely large frames and capable of monitoring traffic from the DUT.

Last Modification: April 28, 2015

Discussion: Jabber refers to a data transmission by the physical layer for an abnormal period of time. Two functions of a repeater's physical layer, MAU or PMA, are to determine whether a stream of data is abnormally long and to interrupt it. An abnormally long transmission is 40,000 to 75,000 bitTimes at 10/100Mb/s, and 80,000 to 150,000 bitTimes at 1000Mb/s. In addition for 10BASE-T if a station has transmitted continuously for between 20 to 150ms then it is required for the device to self interrupt by stopping all data transmissions for between 0.25 and 0.75 seconds.

Although the jabber size is not defined for 10,000Mb/s or greater, the DUT should be capable of recovering from the reception of an oversized frame. For 10,000 Mb/s and greater a 16,384 byte frame will be used as a jabber frame.

Test Setup: Connect the device under test (DUT) to the testing station with the appropriate medium (i.e. unshielded twisted pair (UTP), shielded twisted pair (STP), balanced copper, multi-mode fiber, etc.) and transmit a valid frame to the DUT to ensure that the DUT is functioning properly. See [AnnexC](#) for suggested test configurations.

Procedure:

Part A:

1. The testing station is instructed to transmit a packet maximum jabber size in length, for each jabber size defined for each MAC speed, consisting of 7 bytes of preamble, one byte of SFD and appropriate number of bytes of Data refer to Table 4-7. For 10Mb/s testing send both a 75,000 (7 bytes of preamble, one byte of SFD, and 9367 additional bytes) and a 1,500,000 bit time (7 bytes of preamble, one byte of SFD, and 187492 additional bytes) jabber event.

Part B:

1. The testing station is instructed to transmit the test packet preceded by a valid frame separated by minimum IPG and followed by another valid frame separated by a minimum interPacketGap (as specified in Table 4 - 7).

*The University of New Hampshire
InterOperability Laboratory*

Part C (Only applicable for 10BASE-T):

1. The testing station is instructed to transmit 7 bytes of preamble, one byte of SFD, and 187492 bytes followed by a valid frame separated by the minimum recovery time of .25 seconds.

*The University of New Hampshire
InterOperability Laboratory*

Table 4 - 7 Jabber Frames

Speed	Maximum Jabber Frame	Minimum recovery time
10Mb/s	9367 bytes	96 bit times
100Mb/s	9367 bytes	96 bit times
1000Mb/s	18742 bytes	96 bit times
10,000Mb/s or greater	16384 bytes	96 bit times

Observable Results:

- a. The DUT should discard the jabber packet. Reception of a jabber event should not cause a system failure.
- b. The reception of the jabber frame should not interfere with reception of valid MAC frames. All frames preceding and following the test packets should be properly replied to.
- c. The reception of the jabber event should not interfere with the reception of a following valid MAC frame.

Possible Problems:

- **100BASE-TX:** Even though the maximum jabber event is defined to be 75000 bits, an issue may occur before this maximum number of bits can be transmitted to the DUT. The receive descrambler of the DUT may lose synchronization during the reception of a jabber frame. Typically this can happen when more than 361 μ S passes without receiving at least 29 consecutive plaintext idle pattern bits. Refer to the ANSI X3T9.5 TP-PMD standard in section 7.2.3.3 “Loss of Synchronization”.

The University of New Hampshire
InterOperability Laboratory

Test #4.1.7 - Start Frame Delimiter Error Reception and Recovery

Purpose: To verify that the device under test (DUT) discards frames which do not contain a valid Start Frame Delimiter (SFD).

References:

- [1] IEEE Std 802.3-2012, subclause 3.2.2 - Start Frame Delimiter (SFD) field
- [2] IEEE Std 802.3-2012, subclause 4.2.6 - Start frame sequence
- [3] IEEE Std 802.3-2012, subclause 4.2.9 - Frame reception
- [4] [ANNEX A \(informative\) Table of Acronym Definitions](#)
- [5] [ANNEX B \(informative\) Testing Requirements](#)
- [6] [ANNEX C \(informative\) Suggested Test Setups and Configurations](#)

Resource Requirements: A testing station capable of transmitting arbitrary bit patterns in place of the SFD and capable of monitoring traffic from the DUT.

Last Modification: April 28, 2015

Discussion: The SFD, consisting of the bit pattern 10101011, immediately following the preamble pattern and immediately preceding the destination address indicates the Start of Frame. In order for a frame to be correctly interpreted by the MAC sublayer, a completely formed SFD must be passed across the AUI, MII or GMII. The PhysicalSignalDecap receives one bit at a time until a valid SFD is detected and discards all bits before SFD. Upon reception of the SFD, the PhysicalSignalDecap begins passing successive bits to RecieveLinkMgmt for passing to the LLC sublayer. If there is no SFD following preamble or, if the SFD is invalid, the MAC layer shall not accept the frame.

Test Setup: Connect the device under test (DUT) to the testing station with the appropriate medium (i.e. unshielded twisted pair (UTP), shielded twisted pair (STP), balanced copper, multi-mode fiber, etc.) and transmit a valid frame to the DUT to ensure that the DUT is functioning properly. See [Annex C](#) for suggested test configurations.

Procedure:

Part A:

1. The testing station is instructed to transmit an otherwise valid frame, where the SFD is replaced by another byte of preamble (bit pattern 10101010).
2. The output of the DUT is observed.

Part B:

1. The testing station is instructed to transmit an otherwise valid frame, with the bit pattern 10011011 in place of the SFD.
2. The output of the DUT is observed.

Part C:

1. *Parts A* and *B* are repeated with each test frame preceded and followed by a valid frame, each separated by a minimum interPacketGap.

Observable Results:

- a. The DUT should discard the Test Frame.
- b. The DUT should discard the Test Frame.
- c. The reception of either Test Frame should not interfere with the reception of valid frames.

*The University of New Hampshire
InterOperability Laboratory*

Possible Problems: None

*The University of New Hampshire
InterOperability Laboratory*

Test #4.1.8 - Frames with Alignment Errors

Purpose: To verify that the device under test (DUT) detects and discards frames with alignment errors.

References:

- [1] IEEE Std 802.3-2012, subclause 3.4 - Invalid MAC frame
- [2] IEEE Std 802.3-2012, subclause 4.2.4.2.1 - Framing
- [3] IEEE Std 802.3-2012, subclause 4.2.9 - Frame reception *function* ReceiveData Decap
- [4] IEEE Std 802.3, 2012, subclause 22.2.1.2.1 - Function
- [5] IEEE Std 802.3, 2012, Figure 22-3
- [6] IEEE Std 802.3, 2012, subclause 22.2.3.5 - Handling of excess nibbles
 - (a) 10Mb/s: - 7.2.2.1.3 - INPUT_UNIT
 - (b) 100BASE-X: - Figure 24-4, 24.2.4.4.4 - Stream Termination, Figure 24-11
- [7] [ANNEX A \(informative\) Table of Acronym Definitions](#)
- [8] [ANNEX B \(informative\) Testing Requirements](#)
- [9] [ANNEX C \(informative\) Suggested Test Setups and Configurations](#)

Resource Requirements: A testing station capable of transmitting frames that are not an integer number of octets and capable of monitoring traffic from the DUT.

Last Modification: April 28, 2015

Discussion: Since the format of a valid frame specifies an integer number of octets, at operating speeds less than or equal to 100Mb/s only a collision or an error can produce a frame with a length that is not an integer number of octets. Complete frames that do not contain an integer number of octets should be truncated to the nearest octet boundary. If the FCS field is in error in such a frame, then alignmentError is reported; otherwise the frame should be accepted.

If the device under test (DUT) implements the Media Independent Interface (MII) and is operating at 10Mb/s it will translate the PLS_DATA.indicate primitive to RXD<3:0>. If the DUT implements the MII and is operating at 100Mb/s, it will translate the rx_code-bit to RXD<3:0>. In both these cases the MAC will receive data in nibbles (4 bits) and, therefore, the MAC layer can only receive a nibble of excess data.

If the DUT does not implement the MII the MAC layer receives the PLS_DATA.indicate directly from the Physical Layer Signaling (PLS). In this case the MAC layer can have 1 to 7 bits of excess data.

Test Setup: Connect the device under test (DUT) to the testing station with the appropriate medium (i.e. unshielded twisted pair (UTP), shielded twisted pair (STP), balanced copper, multi-mode fiber, etc.) and transmit a valid frame to the DUT to ensure that the DUT is functioning properly. See [Annex C](#) for suggested test configurations.

Procedure:

Part A:

1. The testing station is used to source a frame to the DUT ending with a valid FCS and 'n' extra bits.
2. Repeat step 1 incrementing 'n' by 'x' according to Table 4 - 8. Ideally all values in the range are tested. Typically one or two values may be checked.

Part B:

1. The testing station is used to source a frame to the DUT ending with an invalid FCS and 'n' extra bits.

*The University of New Hampshire
InterOperability Laboratory*

2. Repeat step 1 incrementing 'n' by 'x' according to Table 4 - 8. Ideally all values in the range are tested. Typically one or two values may be checked.

Table 4 - 8 Value of 'x' for test 4.2.5

DUT	Initial Value of 'n'	Increment 'n' by 'x' bits:	Repeat steps 1 through 2 until 'n' equals:
10Mb/s PLS to MAC	1	$x = 1$	7
10Mb/s MII to MAC	1	$x = 1$	4
100Mb/s	4	<i>N/A</i>	4

Part C:

1. *Parts A and B* are repeated with the test frames preceded and followed by a valid frame, each separated by a minimum interPacketGap (96 bit-times).

Observable Results:

- a. The DUT should truncate the test frame to the nearest octet and accept it.
- b. The DUT should truncate the test frame to the nearest octet, and discard it.
- c. The reception of test frames should not affect the reception of the valid request frames.

Possible Problems:

- For a 10Mb/s device if it cannot be determined whether the DUT implements a PLS or an MII below the MAC layer then the testing is performed as if a PLS is implemented. This is because if between 5 and 7 extra bits are received this may be seen by the MAC as two extra nibbles (an integer number of bytes).

*The University of New Hampshire
InterOperability Laboratory*

Test #4.1.9 - Preamble Error Reception and Recovery

Purpose: To verify that the device under test (DUT) accepts packets which do not contain a normal preamble bit pattern.

References:

- [1] IEEE Std 802.3-2012, subclause 3.2.1 - Preamble field
- [2] IEEE Std 802.3-2012, subclause 4.2.6 - Start frame sequence
- [3] IEEE Std 802.3-2012, subclause 4.2.9 - Frame reception process BitReceiver, procedure PhysicalSignalDecap
- [4] ANNEX A (informative) Table of Acronym Definitions
- [5] ANNEX B (informative) Testing Requirements
- [6] ANNEX C (informative) Suggested Test Setups and Configurations

Resource Requirements: A testing station capable of transmitting arbitrary bit patterns in place of the last byte of preamble and capable of monitoring traffic from the DUT.

Last Modification: May 11, 2011

Discussion: The preamble, consisting of seven bytes of the following bit pattern 10101010, is appended to the beginning of a frame before it is passed down to the physical layer. Upon the reception of a packet the *PhysicalSignalDecap* procedure discards every bit of preamble until a valid Start Frame Delimiter (SFD), the bit pattern 10101011, is seen. After the reception of the SFD, the *PhysicalSignalDecap* begins passing successive bits to RecieveLinkMgmt for passing to the LLC sublayer. The reception of invalid preamble should, therefore, not interfere with the reception of a valid MAC frame, as long as the invalid preamble is not identical to the SFD.

The preamble pattern, however, is used at 10Mb/s to stabilize and synchronize the physical medium; therefore, the reception of invalid preamble could cause a valid frame to be discarded. In addition, the 100BASE-X PCS replaces the first byte of preamble with a Start-of-Stream delimiter (/J/K/), the 1000BASE-X PCS replaces the first byte of preamble with a Start_of_Packet delimiter (/S/), and the 1000BASE-T PCS replaces the first two bytes of preamble with the Start-of-Stream delimiter (two code groups). Upon the reception of a packet these are stripped off by the PCS and replaced with a byte of preamble.

Test Setup: Connect the device under test (DUT) to the testing station with the appropriate medium (i.e. unshielded twisted pair (UTP), shielded twisted pair (STP), balanced copper, multi-mode fiber, etc.) and transmit a valid frame to the DUT to ensure that the DUT is functioning properly. See [Annex C](#) for suggested test configurations.

Procedure:

Part A:

1. The testing station is instructed to transmit a packet with the following bit pattern replacing the normal preamble and SFD bit pattern (for clarity the modified bytes have been underlined):

100/1000BASE-X/10000/40000/100000

10101010 00000000 00000000 00000000 00000000 00000000 00000000 10101011

1000BASE-T

10101010 10101010 00000000 00000000 00000000 00000000 00000000 10101011

*The University of New Hampshire
InterOperability Laboratory*

2. The output of the DUT is observed.

Part B:

1. The testing station is instructed to transmit a packet with the following bit pattern replacing the normal preamble and SFD bit pattern (for clarity the modified bytes have been underlined):

100/1000BASE-X/10000/40000/100000

10101010 01111111 11111111 11111111 11111111 11111111 11111111 10101011

1000BASE-T

10101010 10101010 01111111 11111111 11111111 11111111 11111111 10101011

2. The output of the DUT is observed.

Part C:

1. The testing station is instructed to transmit a packet with the following bit pattern replacing the normal preamble and SFD bit pattern (for clarity the modified bytes have been underlined):

10101010 10101010 10101010 10101010 10101010 10101000 10101111 10101011

2. The output of the DUT is observed.

Part D:

1. *Parts A* through *C* are repeated with each test packet preceded and followed by a valid frame, each separated by a minimum interPacketGap.
2. The output of the DUT is observed.

Observable Results:

- a. The DUT should accept the Test Packet.
- b. The DUT should accept the Test Packet.
- c. The DUT should accept the Test Packet.
- d. The reception of the test packet should not interfere with the reception of valid frames.

Possible Problems: None

GROUP 2: Encapsulation and De-capsulation

Scope: The following tests cover MAC operations specific to the encapsulation and de-capsulation of MAC frames.

Overview: These tests are designed to verify that the device under test properly receives and transmits properly formed MAC frames. The MAC functions explored are defined in Clause 4 of IEEE 802.3.

*The University of New Hampshire
InterOperability Laboratory*

Test #4.2.1 - Transmit Proper Preamble and SFD

Purpose: To verify that the device under test (DUT) properly encapsulates a frame with eight bytes of combined preamble and Start Frame Delimiter (SFD).

References:

- [1] IEEE Std 802.3-2012, subclause 3.2.1 - Preamble field
- [2] IEEE Std 802.3-2012, subclause 3.2.2 - Start Frame Delimiter (SFD) field
- [3] IEEE Std 802.3-2012, subclause 4.2.5 - Preamble generation
- [4] IEEE Std 802.3-2012, subclause 4.2.6 - Start frame sequence
- [5] IEEE Std 802.3-2012, subclause 4.2.8 - Frame transmission
- [6] IEEE Std 802.3-2012, subclause 4.2.9 - Frame reception function TransmitLinkMgmt, procedures PhysicalSignalEncap and PhysicalSignalDecap
 - (a) 10Mb/s: 7.2.3.2 - Preamble, 14.2.1.1 - Transmit function requirements
 - (b) 100BASE-X: 22.2.3.2 - Preamble and start of frame delimiter
 - (c) 1000BASE-T: 35.2.3.2 - Preamble and start of frame delimiter, 40.3.1.3 - PCS transmit function
 - (d) 1000BASE-X: 36.2.4.14 - Start of packet (SPD) delimiter, Figure 36-5 PCS Transmit ordered_set state diagram
- [7] ANNEX A (informative) Table of Acronym Definitions
- [8] ANNEX B (informative) Testing Requirements
- [9] ANNEX C (informative) Suggested Test Setups and Configurations
- [10] ANNEX D Stressing the device under test (DUT)

Resource Requirements: A testing station capable of stressing the DUT and capable of capturing complete packets including the preamble and SFD. MDI, AUI, MII, GMII or PCS access and or control by the testing station are ideal.

Last Modification: April 30, 2015

Discussion: When the MAC is requested to send a new frame, it calls the procedure PhysicalSignalEncap. This procedure transmits 7 bytes of preamble and then 1 byte of SFD. The preamble pattern is used at 10Mb/s to stabilize and synchronize the physical medium. A 10Mb/s device is required to transmit 7 bytes of preamble, however, it is possible for the first two bits in a transmission to be lost while being transmitted from the DO circuit to the TD circuit in the Physical layer. Therefore, at a very minimum, a 10Mb/s device should source packets that have 54 bits of preamble.

For speeds greater than 10 Mb/s, the MAC is still required to transmit preamble and SFD but it is not necessary for stabilization and synchronization. The preamble bit pattern is:

10101010 10101010 10101010 10101010 10101010 10101010 10101010

/I/ is a twenty bit wide signal, for 1000BASE-X, consisting of two 10bit code_groups, /K28.5/D5.6/ or /K28.5/D16.2/. The 1000BASE-X PCS may discard one octet of preamble if TX_EN is set to TRUE while /K28.5/ is being transmitted because the PCS must transmit either /D5.6/ or /D16.2/ even if the first byte of preamble is being passed down from the MAC. The SGMII is a proprietary interface between the MAC and the PHY. It uses the IEEE 802.3 STD clause 36 PCS and PMA to serially transmit and receive packets between the MAC and PHY. Thus 1000BASE-T devices that implement the SGMII interface are susceptible to the loss of one byte of preamble, but, as this is a proprietary interface, these devices will be considered to transmit invalid preamble.

*The University of New Hampshire
InterOperability Laboratory*

Upon the successful transmission of preamble, the MAC shall transmit the SFD, which consists of the pattern 10101011. Any successive bits following the transmission of SFD are recognized by the receiving MAC as data bits and are passed onto the LLC sublayer.

Test Setup: Connect the device under test (DUT) to the testing station with the appropriate medium (i.e. unshielded twisted pair (UTP), shielded twisted pair (STP), balanced copper, multi-mode fiber, etc.) and transmit a valid frame to the DUT to ensure that the DUT is functioning properly. See [Annex C](#) for suggested test configurations.

Procedure:

Part A:

1. The DUT is instructed to transmit a large number of packets, in rapid succession. For possible ways to stress the DUT see *ANNEX D Stressing the device under test (DUT)*.
2. The activity captured by the testing station is observed.

Observable Results:

- a. The testing station should capture several replies from the DUT. The preamble and SFD for each frame should conform to the appropriate bit pattern:

10Mb/s

10101010 10101010 10101010 10101010 10101010 10101010 10101010 10101011
or
01010101 10101010 10101010 10101010 10101010 10101010 10101010 10101011
or
101010 10101010 10101010 10101010 10101010 10101010 10101010 10101011

100BASE-X 1000BASE-T, 10.000Mb/s, 40.000Mb/s, and 100.000Mb/s

10101010 10101010 10101010 10101010 10101010 10101010 10101010 10101011

1000BASE-X

10101010 10101010 10101010 10101010 10101010 10101010 10101010 10101011
or
10101010 10101010 10101010 10101010 10101010 10101010 10101010 10101011

Note: The first octet of preamble is replaced with /J/K/ for 100BASE-X, or /S/ for 1000BASE-X, and the first two octets of preamble are replaced with SSD1 and SSD2 for 1000BASE-T by the PCS. The replaced octets should be received as preamble by the receiving MAC layer.

Possible Problems:

- In order to ensure that a device transmits proper preamble and SFD at all times it is necessary to stress the device. This may be difficult to do when the DUT is an end station.

*The University of New Hampshire
InterOperability Laboratory*

Test #4.2.2 - Transmission of Minimum interPacketGap

Purpose: To verify that the device under test (DUT) enforces minimum interPacketGap spacing of 96 bit times.

References:

- [1] IEEE Std 802.3-2012, subclause 4.1.2.1.1 - Transmission without contention
- [2] IEEE Std 802.3-2012, subclause 4.2.8 - Frame transmission function TransmitLinkMgmt, process deference
- [3] IEEE Std 802.3-2012, subclause 4.4.2 - MAC parameters
- [4] IEEE Std 802.3-2012, Figure 4-1 - Relationship among CSMA/CD procedures
- [5] [ANNEX A \(informative\) Table of Acronym Definitions](#)
- [6] [ANNEX B \(informative\) Testing Requirements](#)
- [7] [ANNEX C \(informative\) Suggested Test Setups and Configurations](#)
- [8] [ANNEX D Stressing the device under test \(DUT\)](#)

Resource Requirements: A testing station that is capable of stressing the DUT and capable of monitoring traffic from the DUT.

Last Modification: April 30, 2015

Discussion: In full duplex mode, the MAC is not required to defer to carrier sense, which is supplied to the MAC by the PHY. It is, however, necessary for the MAC to defer to its own transmission and continue to defer for at least one minimum interPacketGap (96 bit times) after the end of a frame.

At 10Mb/s and 1000Mb/s it is possible for a interPacketGap shrinkage to occur. For 10Mb/s interPacketGap may shrink to a value of 47 bit times, as measured at the AUI. For 1000Mb/s interPacketGap may shrink to a value of 64 bit times as measured at the GMII. For 10,000Mb/s interPacketGap may shrink to a value of 40 bit times as measured at the XGMII. This shrinkage may be caused by variable network delays, added preamble bits, clock skew, clock tolerances, or Deficit Idle Count. This may make it difficult to determine whether a device is transmitting the proper amount of preamble or interPacketGap shrinkage is occurring.

Test Setup: Connect the device under test (DUT) to the testing station with the appropriate medium (i.e. unshielded twisted pair (UTP), shielded twisted pair (STP), balanced copper, multi-mode fiber, etc.) and transmit a valid frame to the DUT to ensure that the DUT is functioning properly. See [AnnexC](#) for suggested test configurations.

Procedure:

Part A (Full Duplex):

1. Place the DUT into Full Duplex. If Flow Control is supported this may also be set.
2. The DUT is instructed to transmit a large number of packets, in rapid succession. For possible ways to stress the DUT see *ANNEX D Stressing the device under test (DUT)*.

Part B (Half Duplex IPG after a frame):

1. Place the DUT into Half Duplex.
2. The DUT is instructed to transmit a large number of packets, in rapid succession. For possible ways to stress the DUT see *ANNEX D Stressing the device under test (DUT)*.

Part C (Half Duplex IPG after a collision):

1. Place the DUT into Half Duplex.
2. Create collisions and observe the transmitted InterPacketGap between the collision fragment and the next transmission from the DUT.

Part D (Half Duplex transmission deference of at least IPG):

*The University of New Hampshire
InterOperability Laboratory*

1. If the testing station is capable of monitoring both transmit and receive simultaneously cause the DUT to attempt the transmission of a frame immediately following a received frame or fragment. Ensure that the DUT does not initiate a new transmission until at least waiting a minimum IPG after the reception of a frame or fragment from the testing station.
2. Create collisions and observe the transmitted InterPacketGap between the collision fragment and the next transmission from the DUT.

*The University of New Hampshire
InterOperability Laboratory*

Observable Results:

- a. All packets captured should have at least a minimum IPG between them.
- b. All packets captured should have at least a minimum IPG between them.
- c. All packets captured should have at least a minimum IPG between them.
- d. All packets captured should have at least a minimum IPG between the end of the reception of a frame by the DUT and the beginning of the transmission from the DUT.

Possible Problems: None.

*The University of New Hampshire
InterOperability Laboratory*

Test #4.2.3 - Compute and Transmit Proper CRC

Purpose: To verify that the device under test (DUT) correctly calculates the CRC-32 value for the frame being transmitted and assigns it to the frame check sequence (FCS) field.

References:

- [1] IEEE Std 802.3-2012, subclause 3.2.9 - Frame Check Sequence (FCS) field
- [2] IEEE Std 802.3-2012, subclause 3.4 - Invalid MAC frame
- [3] IEEE Std 802.3-2012, subclause 4.2.8 - Frame transmission
- [4] [ANNEX A \(informative\) Table of Acronym Definitions](#)
- [5] [ANNEX B \(informative\) Testing Requirements](#)
- [6] [ANNEX C \(informative\) Suggested Test Setups and Configurations](#)

Resource Requirements: A testing station that is capable of capturing frames from the DUT and verifying that each captured frame has the proper CRC-32 value in the FCS field.

Last Modification: April 30, 2015

Discussion: In order to detect certain errors during the reception of a frame, a 32-bit Cyclic Redundancy Check (CRC) value is computed. This value is then inserted into the FCS field. The CRC is computed using the contents of the source address, destination address, VLAN tag (optional), Length/Type, and Data/Pad fields (that is, all fields except the preamble, SFD, and FCS).

Upon the reception of a frame, the same calculation is performed on the incoming data and is compared to the value in the FCS field. If they do not match an error is reported to the MAC client.

Test Setup: Connect the device under test (DUT) to the testing station with the appropriate medium (i.e. unshielded twisted pair (UTP), shielded twisted pair (STP), balanced copper, multi-mode fiber, etc.) and transmit a valid frame to the DUT to ensure that the DUT is functioning properly. See [Annex C](#) for suggested test configurations.

Procedure:

Part A:

1. The DUT is instructed to transmit a number of different frames.
2. The CRC value of each frame is computed by the testing station and compared to the CRC transmitted by the DUT.

Observable Results:

- a. The value of the CRC transmitted by the DUT must match the value calculated by the testing station.

Possible Problems: None

Test #4.2.4 - Receive Variable Preamble

Purpose: To verify that the device under test (DUT) can receive valid packets with varied amounts of preamble.

References:

- [1] IEEE Std 802.3-2012, subclause 4.2.5 - Preamble generation
- [2] IEEE Std 802.3-2012, subclause 4.2.9 - Frame reception, process *BitReceiver* and procedure *PhysicalSignalDecap*
 - (a) 10BASE-T: 7.2.3.2 - Preamble, 14.2.1.1 - Transmit function requirements
 - (b) 100BASE-X: 24.2.2.1.4 - Start-of-Stream delimiter (/J/K/)
 - (c) 1000BASE-X: 35.2.3.2.2 - Receive case, 36.2.4.14 - Start_of_Packet (SPD) delimiter
 - (d) 1000BASE-T: 35.2.3.2.2 - Receive case, 40.3.1.4.1 - Decoding of code-groups, Figure 40-11(a) - PCS Receive State Diagram
- [3] [ANNEX A \(informative\) Table of Acronym Definitions](#)
- [4] [ANNEX B \(informative\) Testing Requirements](#)
- [5] [ANNEX C \(informative\) Suggested Test Setups and Configurations](#)

Resource Requirements: A testing station capable of transmitting packets with varied amounts of preamble and capable of monitoring traffic from the DUT.

Last Modification: April 30, 2015

Discussion: When the MAC is receiving a packet, the process *BitReceiver* first calls the procedure *PhysicalSignalDecap*. This procedure receives one bit at a time from the physical medium and discards all bits until a valid SFD is detected. At this point the *BitReceiver* process accepts bits while the *receiveDataValid* signal is asserted and the packet is not finished. Preamble is not used by the MAC layer so the minimum amount of preamble required for a device to function properly depends upon which physical layer is implemented and not upon the MAC layer.

At speeds less than 100 Mb/s, preamble is required for the synchronization of the receiver. The minimum amount of preamble that can be transmitted by a 10BASE-T device is 56 bits; two bits may be lost in the MAU between the DO circuit and the TD circuit. Therefore the 10BASE-T PHY should be able to handle a minimum of 54 bits of preamble.

At speeds greater than 10Mb/s preamble is not required for the synchronization of the receiver, however, the first octet of preamble is replaced with /J/K/ for 100BASE-X, or /S/ for 1000BASE-X, and the first two octets of preamble are replaced with SSD1 and SSD2 for 1000BASE-T by the PCS. The receiver's MAC layer should receive the replaced octets as preamble.

Though no more than 12 bytes of preamble will be observed within a compliant network, a MAC layer should tolerate large amounts of preamble. For 10,000Mb/s, the MAC is not required to process a packet that has an SFD in a position other than lane 3 of the column following the Start control character. For 40,000Mb/s and 100,000 Mb/s, the MAC is not required to process a packet that has more or less than 6 bytes of preamble.

Test Setup: Connect the device under test (DUT) to the testing station with the appropriate medium (i.e. unshielded twisted pair (UTP), shielded twisted pair (STP), balanced copper, multi-mode fiber, etc.) and transmit a valid packet to the DUT to ensure that the DUT is functioning properly. See [Annex C](#) for suggested test configurations.

Procedure:

Part A:

*The University of New Hampshire
InterOperability Laboratory*

1. The testing station is instructed to transmit a packet with the minimum amount of preamble followed by the SFD.
2. The testing station is then instructed to increment the amount of Preamble by 'n' and retransmit the packet.
3. Ideally, step 2 is repeated until a combined preamble and SFD of 64 bytes in length is obtained. Typically, a few different amounts of combined preamble and SFD are tested.

*The University of New Hampshire
InterOperability Laboratory*

Observable Results:

- a. The DUT should accept the test packet with at least the minimum required preamble, as indicated in Table 4 - 9, and an SFD. Packets with more than the minimum required preamble and an SFD should also be accepted by the DUT. For 10,000Mb/s, the MAC is not required to process a packet that has an SFD in a position other than lane 3 of the column following the Start control character. For 40,000Mb/s and 100,000 Mb/s, the MAC is not required to process a packet that has more or less than 6 bytes of preamble.

Table 4 - 9 Acceptable Amounts of Preamble

	Minimum Preamble Required by the PHY	Value for 'n'
10Mb/s	54 bits	1 bit
100BASE-FX	1 byte	4 bits
100BASE-TX		
1000BASE-T	2 bytes	1 byte
1000BASE-X	1 byte	1 byte
10,000Mb/s	1 byte	1 byte

Possible Problems: None

*The University of New Hampshire
InterOperability Laboratory*

Test #4.2.5 - Receive all Frame Sizes

Purpose: To verify that the device under test (DUT) properly accepts all valid sized frames.

References:

- [1] IEEE Std 802.3-2012, subclause 3.1.1 - Packet format
- [2] IEEE Std 802.3-2012, subclause 3.2.7 - MAC Client Data field
- [3] IEEE Std 802.3-2012, subclause 4.2.4.2.1 - Framing
- [4] IEEE Std 802.3-2012, subclause 4.2.7.1 - Common constants, types, and variables
- [5] IEEE Std 802.3-2012, subclause 4.2.9 - Frame reception
- [6] IEEE Std 802.3-2012, subclause 4.4.2 - MAC parameters
- [7] IEEE Std 802.3, 2012 Edition – Figure 3-1 - Packet format
- [8] [ANNEX A \(informative\) Table of Acronym Definitions](#)
- [9] [ANNEX B \(informative\) Testing Requirements](#)
- [10] [ANNEX C \(informative\) Suggested Test Setups and Configurations](#)

Resource Requirements: A testing station that is capable of transmitting valid untagged and tagged frames from minFrameSize to the maximum permitted frame size, and capable of monitoring traffic from the DUT.

Last Modification: May 8, 2015

Discussion: The MAC frame, as defined in clause 3.1.1, has a minFrameSize of 512 bits (64 bytes) and a maxUntaggedFrameSize of 1518 bytes. When receiving a frame, the MAC layer of the receiving station interprets the value of the 2-octet long Length/Type field of the frame. If the value in the Length/Type field is greater than or equal to 1536 then the value indicates the type of the frame, or if the value in the field is less than or equal to 1500 then the value indicates the length of the frame. All other values are undefined. The minimum length of the Data/Pad field is 46 bytes; if the length value in the Length/Type field is less than 46 then all extra bytes are considered Pad. The DUT should be able to receive frames of all valid lengths with both length and type values in the Length/Type field as long as the length or type values are valid and supported by the DUT.

One of the differences between 802.3 2005 and 2012 editions is the handling of the maximum permitted frame size. The standard now specifies in section 3.2.7 NOTE 2 “All IEEE 802.3 MAC frames share a common format. The processing of the three types of MAC frames is not differentiated within the IEEE 802.3 MAC, except for management. However, they may be distinguished within the MAC client.” So the differentiation between the three types of frames (basic, Q-tagged, and envelope frames) is not distinguished at the MAC, but now can be by the MAC Client. For the MAC it is to use 1518, 1522, or 2000 as the limit for maxFrameSizeLimit. The MAC Client of the DUT may differentiate though.

The MAC Client may support VLAN tagging, which increases the maximum permitted size of a tagged frame to 1522 bytes (maxUntaggedFrameSize + qTagPrefixSize). The DUT should accept all frames from minFrameSize to maxUntaggedFrameSize. If the DUT supports VLAN tagging, then all untagged frames from minFrameSize to maxUntaggedFrameSize should be accepted and all tagged frames from minFrameSize to (maxUntaggedFrameSize + qTagPrefixSize) should be accepted.

The MAC may support envelope frames. If so, the MAC should accept all frames from 64 to 2000 bytes in length.

Test Setup: Connect the device under test (DUT) to the testing station with the appropriate medium (i.e. unshielded twisted pair (UTP), shielded twisted pair (STP), balanced copper, multi-mode fiber, etc.) and

*The University of New Hampshire
InterOperability Laboratory*

transmit a valid frame to the DUT to ensure that the DUT is functioning properly. See [Annex C](#) for suggested test configurations.

*The University of New Hampshire
InterOperability Laboratory*

Procedure:

Part A:

1. The testing station is instructed to transmit a 64 byte untagged frame. The output of the DUT is observed.
2. The test frame is then incremented by one octet and step 1 is repeated until the test frame is `maxUntaggedFrameSize` (1518 bytes) in length.

Part B:

1. The testing station is instructed to transmit a 64 byte frame with a length value of `0x0001`. The output of the DUT is observed.
2. If the length value is less than `0x002E` then the length value is incremented by one. If the length value is `0x002E` or higher then the length of the test frame is then incremented by one octet and the length value in the Length/Type field is incremented by one. Step 1 is repeated until the test frame is `maxUntaggedFrameSize` in length and the length value is `0x05DC`.

Part C:

1. The testing station is instructed to transmit a 64 byte tagged MAC frame. The output of the DUT is observed.
2. The test frame is then incremented by one octet and step 1 is repeated until the test frame is `maxUntaggedFrameSize + qTagPrefixSize` (1522 bytes) in length.

Part D:

1. The testing station is instructed to transmit a 64 byte envelope frame. The output of the DUT is observed.
2. The test frame is then incremented by one octet and step 1 is repeated until the test frame is `maxEnvelopeFrameSize` (2000 bytes) in length.

Part E (1000Mb/s only):

1. The testing station is instructed to transmit a 64 byte frame extended to 512 bytes. The output of the DUT is observed.
2. The test frame is then incremented by one octet and step 1 is repeated until the test frame is equal to 511 bytes in length, extended with extension by one byte to 512 bytes in length.

Observable results:

- a. The DUT should accept all untagged frames from 64 to 1518 bytes in length.
- b. The DUT should accept all frames with valid length values from `0x0001` to `0x05DC`.
- c. If VLAN tagging is supported, the DUT should accept all tagged frames 64 to 1518 bytes in length. Tagged frames from 1519 to 1522 bytes in length may be accepted by the DUT.
- d. If Envelope frames are supported the DUT should accept all envelope frames from 64 to 2000 bytes in length.
- e. The DUT should accept all frames from 64 to 511 bytes in length containing extension (to extend it to 512-bytes in length).

Possible Problems:

- The MAC Client of the DUT may not support Q-tagged or envelope frames.

*The University of New Hampshire
InterOperability Laboratory*

- At 1000Mb/s and in half duplex mode extension will have to be added to frames less than slotTime in length.
- The DUT may not reply to frames with length values or may reply to these frames with frames containing type values in the Length/Type field.
- If the passReceiveFCSType variable is false, for frames with a length value less than 0x002E the removePad function should truncate the data param to the number bytes specified in the Length/Type field, possibly causing insufficient data for the proper operation of the higher layer protocol.

*The University of New Hampshire
InterOperability Laboratory*

Test #4.2.6 - Reception of Minimum interPacketGap

Purpose: To determine whether or not the device under test (DUT) is capable of receiving packets separated by a minimum interPacketGap (IPG)

References:

- [1] IEEE Std 802.3-2012, subclause 4.2.3.2.1 - Deference
- [2] IEEE Std 802.3-2012, subclause 4.2.3.2.2 - Interpacket gap
- [3] IEEE Std 802.3-2012, subclause 4.4.2 - MAC parameters
 - (a) 10Mb/s: 7.2.1.1.2 - output_idle message
 - (b) 100BASE-X: 22.2.3.1 - Inter-frame, Table 24-1
 - (c) 1000BASE-X: 36.2.4.15 End_of_Packet delimiter (EPD), Table 36-3
 - (d) 1000BASE-T: 40.3.1.3 - PCS Transmit function
- [4] [ANNEX A \(informative\) Table of Acronym Definitions](#)
- [5] [ANNEX B \(informative\) Testing Requirements](#)
- [6] [ANNEX C \(informative\) Suggested Test Setups and Configurations](#)

Resource Requirements: A testing station capable of transmitting packets with an interPacketGap of 96 bit times and capable of monitoring traffic from the DUT.

Last Modification: May 8, 2015

Discussion: The minimum interPacketGap is specified as 96 bit times regardless of the physical speed of the device. Regardless of the IPG used in transmission, the DUT must be capable of receiving packets separated by at least one IPG.

At 10Mb/s and 1000Mb/s it is possible for an interPacketGap shrinkage to occur. For 10Mb/s interPacketGap may shrink to a value of 47 bit times, as measured at the AUI. For 1000Mb/s interPacketGap may shrink to a value of 64 bit times as measured at the GMII. For 10,000Mb/s interPacketGap may shrink to a value of 40 bit times as measured at the XGMII. For 40,000Mb/s and 100,000Mb/s interPacketGap may shrink to a value of 8 bit times as measured at the XLGMII/CGMII. This shrinkage may be caused by variable network delays, added preamble bits, clock skew, clock tolerances, or Deficit Idle Count. Because of this shrinkage a device may receive packets separated by less than 96 bit times.

Test Setup: Connect the device under test (DUT) to the testing station with the appropriate medium (i.e. unshielded twisted pair (UTP), shielded twisted pair (STP), balanced copper, multi-mode fiber, etc.) and transmit a valid packet to the DUT to ensure that the DUT is functioning properly. See [Annex C](#) for suggested test configurations.

Procedure:

Part A:

1. The testing station is instructed to transmit two valid packets separated by a minimum IPG of 96 bit times.

Part B:

1. Transmit two valid packets separated by $[96 - n * i]$ bit times, where i is greater than or equal to 0 and n is equal to the value specified in Table 4 - 10 Value of 'n' for test 4.2.6.
2. The testing station is instructed to find the maximum value of $n*i$ such that the DUT still responds to both packets (the smallest interPacketGap where both frames are responded to appropriately).

Speed	Value of 'n' in bit times
10Mb/s	1

*The University of New Hampshire
InterOperability Laboratory*

100Mb/s	0.8 (1 bit at PHY)
1000Mb/s	8
10,000Mb/s	8
40,000Mb/s	8
100,000Mb/s	8

Table 4 - 10 Value of 'n' for test 4.2.6

Observable Results:

- a. The DUT must properly respond to the two packets that are separated by the minimum interPacketGap.
- b. The DUT may respond to two packets that are separated by less than minimum interPacketGap. The smallest interPacketGap where the DUT responded to both packets is included for informative purposes.

Possible Problems: None

The University of New Hampshire
InterOperability Laboratory

Test #4.2.7 - Compute and Transmit Proper Extension

Purpose: To verify that the device under test (DUT) correctly calculates the amount of extension needed while transmitting a frame that is less than slotTime.

References:

- [1] IEEE Std 802.3-2012, subclause 3.2.10 - Extension field
- [2] IEEE Std 802.3-2012, subclause 4.2.3.4 - Carrier extension (half duplex mode only)
- [3] IEEE Std 802.3-2012, subclause 4.2.8 - Frame transmission, *process* BitTransmitter, *procedure* NextBit, *procedure* InterFrameSignal
- [4] IEEE Std 802.3-2012, subclause 4.4.2 - MAC parameters
 - (a) 1000BASE-X: 36.2.4.15 End_of_Packet delimiter (EPD), 36.2.4.15.1 - EPD rules, 36.2.4.16 - Carrier_extend (/R/), and 36.2.4.16.1 - Carrier_Extend rules
- [5] [ANNEX A \(informative\) Table of Acronym Definitions](#)
- [6] [ANNEX B \(informative\) Testing Requirements](#)
- [7] [ANNEX C \(informative\) Suggested Test Setups and Configurations](#)

Resource Requirements: A testing station capable of stressing the DUT and capable of capturing complete packets including carrier extension bits. GMII or PCS access and or control by the testing station are ideal.

Last Modification: May 8, 2015

Discussion: In half-duplex mode, at 1000Mb/s, the slotTime value employed at 100Mb/s or less is not sufficient to allow network topologies of adequate size. In order to maintain backwards compatibility the minimum frame size has not been modified. Rather extension bits are added to frames when necessary in order to achieve a slotTime of 4096 bit times (512 byte times). This ensures that all transmissions are at least slotTime in length. The extension field follows the FCS field, and is made up of a sequence of extension bits, which are readily distinguished from data bits. When transmitting extension the GMII signals should be TX_EN de-asserted, TX_ER asserted and TXD<7:0> = 0x0F. The necessary number of extension bits is determined by the *process* BitTransmitter and the *procedure* NextBit. The length of the field may be from zero to (slotTime – minFrameSize) or 448 bytes. The contents of the Extension field are not included in the FCS computation.

For 1000BASE-X, the End_of_Packet delimiter (EPD) is considered to be part of IPG and extension. The PCS layer adds an EPD, which consists of /T/R/ or /T/R/R/ depending of the length of the frame, to the end of each frame. If the MAC layer indicates that there is extension to be transmitted, then the PCS continues to add /R/ code_groups until the MAC layer indicates otherwise.

It has also been observed that some devices have bursting set to true by default regardless of whether or not there is another frame queued for transmission. In this case an extra 12 bytes of extension should be observed as determined by the *procedure* InterFrameSignal.

If the 1000Mb/s half duplex MAC receives a packet that is not slotTime in length, extended to slotTime, or part of a burst then that packet is considered to be a fragment and should be discarded. If a device does not add enough extension bits to a packet then otherwise valid frames could be discarded.

Test Setup: Connect the device under test (DUT) to the testing station with the appropriate medium (i.e. unshielded twisted pair (UTP), shielded twisted pair (STP), balanced copper, multi-mode fiber, etc.) and transmit a valid frame to the DUT to ensure that the DUT is functioning properly. See [Annex C](#) for suggested test configurations.

Procedure:

*The University of New Hampshire
InterOperability Laboratory*

Part A:

1. The testing station is instructed to transmit a 64 byte frame and 448 bytes of extension. The output of the DUT is observed.
2. Ideally, the test frame is incremented by one octet, while the length of extension is decremented by one octet, and step 1 is repeated until the frame size is equal to slotTime (4096 bitTimes). Typically, a small number of frames are sent, these frames shall be less than slotTime in length but extended to slotTime.

Observable Results:

- a. The testing station should capture a reply to each test frame. This reply should consist of the test frame extend to slotTime (4096 bitTimes)

Possible Problems: None

*The University of New Hampshire
InterOperability Laboratory*

Test #4.2.8 - Receive Packets with Extension

Purpose: To verify that the device under test (DUT) can receive a packet with carrier extension at 1000Mb/s.

References:

- [1] IEEE Std 802.3, 2012 Edition, subclause 4.2.9 - Frame reception, *function* ReceiveDataDecap, *process* BitReceiver
- [2] [ANNEX A \(informative\) Table of Acronym Definitions](#)
- [3] [ANNEX B \(informative\) Testing Requirements](#)
- [4] [ANNEX C \(informative\) Suggested Test Setups and Configurations](#)

Resource Requirements: A testing station that is capable of transmitting packets with carrier extension and capable of monitoring traffic from the DUT.

Last Modification: May 8, 2015

Discussion: In half duplex mode at 1000Mb/s, carrier extension is utilized to ensure adequate propagation time delay, without needing to increase minFrameSize. During the *ReceiveDataDecap* function a frame receives *receiveOK* status if no errors are contained within carrier extension (*extensionOK*). A device should, therefore accept any packet with extension, which has a carrier event that is at least slotTime in length.

In full duplex mode and at 1000Mb/s, carrier extension is not needed to ensure adequate propagation time delay; therefore, transmitted frames need only to meet minFrameSize in length. During the *ReceiveDataDecap* function, however, a frame receives *receiveOK* status if no errors are contained within carrier extension (*extensionOK*). A device should, therefore, accept a packet that has any amount of carrier extension.

In addition, the abundance of 1000BASE-X MAC/PCS combo chips and the lack of GMII interface chips caused many early 1000BASE-T devices to use the setup illustrated in Figure 4 - 5 (A similar setup is used by 1000BASE-T GBICs):

Given this implementation and the way the 1000BASE-X PCS functions, odd length frames transmitted by any device implementing the above configuration may have an extra byte of carrier extension appended to the end of the packet. This is because of the End_of_Packet delimiter (EPD) used by the 1000BASE-X PCS for odd sized frames, which consists of /T/R/R/. The /R/ code-group is also used by the 1000BASE-X PCS to denote carrier extension.

It has been demonstrated that some 1000BASE-T devices reject odd length packets with one byte of extension causing interoperability problems. While this set up may not be common, a 1000BASE-T device should be able to receive odd sized packets with one byte of carrier extension.

Figure 4 - 5 1000BASE-T PHY Utilizing a MAC/1000BASE-X PCS Combo Chip

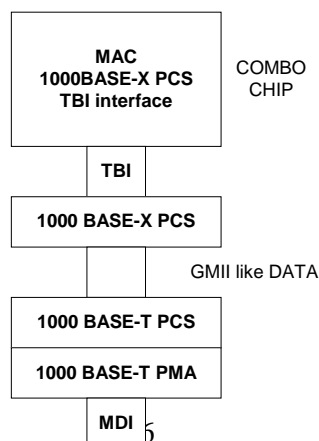

*The University of New Hampshire
InterOperability Laboratory*

Test Setup: Connect the device under test (DUT) to the testing station with the appropriate medium (i.e. unshielded twisted pair (UTP), shielded twisted pair (STP), balanced copper, multi-mode fiber, etc.) and transmit a valid frame to the DUT to ensure that the DUT is functioning properly. See [Annex C](#) for suggested test configurations.

Procedure:

Full Duplex

Part A:

1. The testing station is instructed to transmit a valid 64 byte frame with one byte of extension.
2. The testing station is then instructed to retransmit the test packet after incrementing the length of extension by one. This step is repeated until [frame length + extension length] equals 1518 bytes.
3. The testing station is instructed to increment the length of the test frame by one byte and set the amount of extension to one byte.
4. Ideally, steps 2 and 3 would be repeated until the length of the test frame is 1517 bytes and the amount of extension is 1 byte. Typically, two or three test frames, varying from 64 to 1518 bytes in length, with varying amounts of extension are transmitted.

Part B:

1. *Parts A* through *C* are repeated with the test packet preceded and followed by a valid frame, each separated from the valid packets by a minimum interPacketGap (96 bit-times).

Half Duplex

Part A:

1. The testing station is instructed to transmit a valid 512 byte frame with one byte of extension.
2. The testing station is then instructed to retransmit the test packet after incrementing the length of extension by one. This step is repeated until [frame length + extension length] equals 1518 bytes.
3. The testing station is instructed to increment the length of the test frame by one byte and set the amount of extension to one byte.
4. Ideally, steps 2 and 3 would be repeated until the length of the test frame is 1517 bytes and the amount of extension is 1 byte. Typically, two or three test frames, varying from 64 to 1518 bytes in length, with varying amounts of extension are transmitted.

Part B:

1. *Parts A* through *C* are repeated with the test packet preceded and followed by a valid frame, each separated from the valid packets by a minimum interPacketGap (96 bit-times).

Observable Results:

- a. The DUT should accept each test packet.
- b. The reception of the test packet should not interfere with the reception of valid frames.

Possible Problems: None

GROUP 3: Full Duplex

Scope: The following tests cover MAC operations specific to full duplex operation of the MAC.

Overview: These tests are designed to verify that the device under test properly implements the full duplex operation of the MAC. The MAC functions explored are defined in Clause 4 of IEEE 802.3.

Test #4.3.1 - Does not Defer

Purpose: To verify that the device under test (DUT) does not defer to carrier sense while in Full Duplex mode.

References:

- [1] IEEE Std 802.3-2012, subclause 4.1.2.1.1 - Transmission without contention
- [2] IEEE Std 802.3-2012, subclause 4.2.8 - Frame transmission, *function* TransmitLinkMgmt, process deference
- [3] IEEE Std 802.3-2012, Figure 4-1 - Relationship among CSMA/CD procedures
- [4] ANNEX A (informative) Table of Acronym Definitions
- [5] ANNEX B (informative) Testing Requirements
- [6] ANNEX C (informative) Suggested Test Setups and Configurations

Resource Requirements: A testing station capable of generating traffic and capable of capturing frames with precise timestamps. MDI, AUI, MII, GMII or PCS access and or control by the testing station are ideal.

Last Modification: June 4, 2015

Discussion: Carrier sense is a physical signal provided to the MAC sublayer by the Physical layer, and it is asserted when any device on the network is transmitting. In half-duplex mode, the MAC must defer to carrier sense when there is a frame waiting to be sent. In full duplex mode, the MAC is required to have dedicated transmit and receive channels, this means that no collisions can occur. Therefore, deferring to carrier sense (traffic on the receive channel) is unnecessary. The MAC, however, must always defer to its own transmissions.

Test Setup: Connect the device under test (DUT) to the testing station with the appropriate medium (i.e. unshielded twisted pair (UTP), shielded twisted pair (STP), balanced copper, multi-mode fiber, etc.) and transmit a valid frame to the DUT to ensure that the DUT is functioning properly. See [Annex C](#) for suggested test configurations.

Procedure:

Part A:

1. The testing station is instructed to transmit a valid frame, a variable sized gap and then a long carrier event of sufficient length to determine whether or not deference has occurred. The choice of how long to make the gap may vary from device to device, but should be chosen such that the reply will occur partway through the long carrier event.

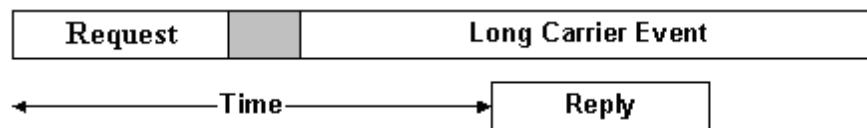

Figure 4 - 6 Does not defer

Observable Results:

- a. The testing station should receive a reply to the test frame. While in full duplex, the DUT should not defer to the long carrier event (the amount of time between when the testing station transmits the test frame and when it receives a reply to it should be less than the long carrier event).

*The University of New Hampshire
InterOperability Laboratory*

Possible Problems:

- Some devices may take a long time to generate a reply to the test frame, and the reply time may vary.
- If a device replies to the request frame too rapidly this may start during the gap between the request and the Long Carrier Event. If the gap could not be made small enough alternate testing procedures may need to be employed.

*The University of New Hampshire
InterOperability Laboratory*

Test #4.3.2 - No Collisions

Purpose: To verify that no collisions occur when the device under test (DUT) is in full duplex mode.

References:

- [1] IEEE Std 802.3-2012, subclause 4.1.2.1.1 - Transmission without contention
- [2] IEEE Std 802.3-2012, subclause 4.2.4.2.2 - Collision filtering
- [3] IEEE Std 802.3-2012, subclause 4.2.8 - Frame transmission
- [4] IEEE Std 802.3-2012, subclause 4.3.3 - Services required from the Physical Layer, function TransmitLinkMgmt
- [5] IEEE Std 802.3-2012 Edition, Figure 4-1 - Relationship among CSMA/CD procedures
- [6] [ANNEX A \(informative\) Table of Acronym Definitions](#)
- [7] [ANNEX B \(informative\) Testing Requirements](#)
- [8] [ANNEX C \(informative\) Suggested Test Setups and Configurations](#)

Resource Requirements: A testing station capable of transmitting a frame so that it is received while the DUT is transmitting and capable of monitoring traffic from the DUT.

Last Modification: June 4, 2015

Discussion: Carrier sense is a physical signal provided to the MAC sublayer by the Physical layer, and it is asserted when any device on the network is transmitting. In half-duplex mode, if carrier sense is asserted while a device is transmitted then a collision has occurred and the device must cease transmission of data and transmit a 32-bit jam pattern. In full duplex mode, the MAC is required to have dedicated transmit and receive channels, this means that no collisions can occur. Therefore, a device should not cause a collision when carrier sense is asserted while a frame is being transmitted.

Test Setup: Connect the device under test (DUT) to the testing station with the appropriate medium (i.e. unshielded twisted pair (UTP), shielded twisted pair (STP), balanced copper, multi-mode fiber, etc.) and transmit a valid frame to the DUT to ensure that the DUT is functioning properly. See [Annex C](#) for suggested test configurations.

Procedure:

Part A:

1. The DUT is instructed to transmit a valid frame.
2. The testing station is instructed to transmit a second valid frame such that a collision would occur within slotTime if the device were in half duplex mode.
3. The output of the DUT is observed.

Observable Results:

- a. The testing station should accept and respond to both frames. While in full duplex, no collisions or collision fragments should be observed.

Possible Problems: None

*The University of New Hampshire
InterOperability Laboratory*

Test #4.3.3 - No Extension

Purpose: To verify that the device under test (DUT) does not add extension to valid frames that are less than slotTime when in full duplex mode and at 1000Mb/s.

References:

- [1] IEEE Std 802.3-2012, subclause 4.2.7.4 - State variable initialization, *procedure* Initialize,
- [2] IEEE Std 802.3-2012, subclause 4.2.8 - Frame transmission, *procedure* NextBit
- [3] [ANNEX A \(informative\) Table of Acronym Definitions](#)
- [4] [ANNEX B \(informative\) Testing Requirements](#)
- [5] [ANNEX C \(informative\) Suggested Test Setups and Configurations](#)

Resource Requirements: A testing station capable of stressing the DUT and capable of capturing complete frames including carrier extension bits. MDI, AUI, MII, GMII or PCS access and or control by the testing station are ideal.

Last Modification: June 4, 2015

Discussion: At 1000Mb/s and in half duplex mode, the slotTime used for 10Mb/s and 100Mb/s is not large enough to propagate a collision to the extent required to support the desired network size. The length of slotTime was, therefore, lengthened from 512 bits to 4096 bits. In order to ensure that the minFrameSize did not have to be changed, carrier extension is appended to the end of the MAC frame. Carrier extension ensures that a receiver's PHY asserts carrier sense for slotTime (4096 bits) for frames that are less than slotTime in length.

In full-duplex mode at operating speeds at 1000Mb/s, carrier extension is not needed to ensure adequate propagation time delay; therefore, transmitted frames need only to meet minFrameSize in length.

Test Setup: Connect the device under test (DUT) to the testing station with the appropriate medium (i.e. unshielded twisted pair (UTP), shielded twisted pair (STP), balanced copper, multi-mode fiber, etc.) and transmit a valid frame to the DUT to ensure that the DUT is functioning properly. See [Annex C](#) for suggested test configurations.

Procedure:

Part A:

1. The testing station is instructed to transmit a valid 64 byte frame.
2. The testing station is instructed to retransmit the test frame, after incrementing its size by one.
3. Ideally, step 2 is repeated until the size of the test frame equals 511. Typically, a few sizes, varying from minFrameSize to one less than slotTime, are used.

Observable Results:

- a. All frames transmitted by the DUT should not contain carrier extension.

Possible Problems:

- For 1000BASE-X, one or two bytes of carrier extension, defined as /R/ by the clause 36 PCS, are added to the end of each packet as part of the End_of_Packet delimiter (/T/R/ or /T/R/R/). If a 1000BASE-X device transmits more than one /R/ code-groups after the transmission of an odd sized frame or more than two /R/ code-groups after the transmission of an even sized frame, then the device shall be observed to transmit carrier extension.

*The University of New Hampshire
InterOperability Laboratory*

Test #4.3.4 - No Bursting

Purpose: To verify that the device under test (DUT), at 1000Mb/s and in full duplex mode, does not go into burst mode when it has acquired the medium and there are still frames to send.

References:

- [1] IEEE Std 802.3-2012 Edition, subclause 4.2.8 - Frame transmission *function* TransmitLinkMgmt.
- [2] [ANNEX A \(informative\) Table of Acronym Definitions](#)
- [3] [ANNEX B \(informative\) Testing Requirements](#)
- [4] [ANNEX C \(informative\) Suggested Test Setups and Configurations](#)
- [5] [ANNEX D Stressing the device under test \(DUT\)](#)

Resource Requirements: A testing station capable of stressing the DUT and capable of capturing complete packets including carrier extension bits. MDI, AUI, MII, GMII or PCS access and or control by the testing station are ideal.

Last Modification: June 4, 2015

Discussion: In half duplex mode at 1000Mb/s, once a device has transmitted a packet, it may maintain control of the medium by transmitting carrier extension followed by another packet, followed by carrier extension, followed by another packet, etc. This is referred to as a burst.

In full-duplex mode at 1000Mb/s, once a packet has been successfully transmitted, a device can begin transmission of another packet without contending for the medium because the device need only defer to its own transmission. It is, therefore, not necessary for a device to maintain control of the medium by bursting.

Test Setup: Connect the device under test (DUT) to the testing station with the appropriate medium (i.e. unshielded twisted pair (UTP), shielded twisted pair (STP), balanced copper, multi-mode fiber, etc.) and transmit a valid packet to the DUT to ensure that the DUT is functioning properly. See [Annex C](#) for suggested test configurations.

Procedure:

Part A:

1. The DUT is instructed to transmit a large number of 64-byte packets in rapid succession. For possible ways to stress the DUT see *ANNEX D Stressing the device under test (DUT)*.
2. The DUT is instructed to transmit a large number of 1518-byte packets in rapid succession. For possible ways to stress the DUT see *ANNEX D Stressing the device under test (DUT)*.

Observable Results:

- a. The testing station should receive at least five 64-byte packets separated by at least one minimum IPG. The testing station should also receive at least five 1518-byte packets separated by at least one minimum IPG. None of the observed IPG should consist of carrier extension.

Possible Problems:

- It may be difficult to ensure that the DUT will not go into burst mode. Detecting a burst mode transmission can be verified by observing carrier extension during IPG. If the DUT is observed to only transmit idle between each test frame, we cannot ensure that the DUT will never go into burst mode. This could be due to timing issues, which were not conducive to burst mode.
- Some devices may not support packet bursting.

*The University of New Hampshire
InterOperability Laboratory*

GROUP 4: Collision Behavior

Scope: The following tests cover MAC operations specific to collision enforcement and detection.

Overview: These tests are designed to verify that the device under test properly implements the Carrier Sense Multiple Access with Collision Detection (CSMA/CD) algorithm as it pertains to the MAC function. The MAC functions explored are defined in Clause 4 of IEEE 802.3.

Test #4.4.1 - Collisions During Preamble and SFD within slotTime.

Purpose: To verify that the device under test (DUT) detects and enforces collisions that occur during the transmission of preamble and SFD within slotTime.

References:

- [1] IEEE Std 802.3-2012, subclause 4.1.2.2 - Access interference and recovery
- [2] IEEE Std 802.3-2012, subclause 4.2.3.2.3 - Collision handling (half duplex mode only)
- [3] IEEE Std 802.3-2012, subclause 4.2.3.2.4 - Collision detection and enforcement (half duplex mode only)
- [4] IEEE Std 802.3-2012, subclause 4.2.3.2.5 - Collision backoff and retransmission (half duplex mode only)
- [5] IEEE Std 802.3-2012, subclause 4.2.3.4 - Carrier extension (half duplex mode only)
- [6] IEEE Std 802.3-2012, subclause 4.2.4.2.2 - Collision filtering
- [7] IEEE Std 802.3-2012, subclause 4.2.8 - Frame transmission, *procedure* WatchForCollisions
- [8] IEEE Std 802.3-2012, subclause 4.4.2 - MAC parameters
- [9] IEEE Std 802.3-2012, Figure 4-2 (a): Transmit Frame State Diagram
 - (a) 10Mb/s: - 4.4.2 - MAC parameters
 - (b) 100BASE-X: - 4.4.2 - MAC parameters, 22.2.2.12 - COL (collision detected), 24.2.4.2 - Transmit
 - (c) 1000BASE-X: - 4.4.2 - MAC parameters, 35.2.2.12 - COL (collision detected), and Figure 35-15
 - (d) 1000BASE-T: - 4.4.2 - MAC parameters, 40.1.3.1 - Physical coding sublayer (PCS), 40.3.1.3 - PCS transmit function
- [10] [ANNEX A \(informative\) Table of Acronym Definitions](#)
- [11] [ANNEX B \(informative\) Testing Requirements](#)
- [12] [ANNEX C \(informative\) Suggested Test Setups and Configurations](#)

Resource Requirements: A testing station capable of transmitting a frame so that it is received while the DUT is transmitting and capable of monitoring traffic from the DUT.

Last Modification: June 4, 2015

Discussion: In half duplex mode the MAC sublayer monitors collisionDetect while it is transmitting a frame. The collisionDetect signal is generated only during transmission and is never true at any other time; in particular, it cannot be used during frame reception to detect collisions between two or more other stations. If a station is transmitting and the physical layer asserts collisionDetect signal, then a collision event has occurred.

A collision may occur during the generation of preamble or SFD. When this occurs, the station must complete transmission of preamble, transmit SFD and then transmit a 32-bit “jam” signal to enforce the collision. The content of “jam” is unspecified; it may be any fixed or variable pattern convenient to the media access implementation. The pattern shall not be intentionally designed to be the 32-bit CRC value corresponding to the (partial) frame transmitted prior to the jam. After a collision has occurred during the transmission of preamble or SFD the DUT should attempt to retransmit the frame.

Test Setup: Connect the device under test (DUT) to the testing station with the appropriate medium (i.e. unshielded twisted pair (UTP), shielded twisted pair (STP), balanced copper, multi-mode fiber, etc.) and transmit a valid frame to the DUT to ensure that the DUT is functioning properly. See [Annex C](#) for suggested test configurations.

Procedure:

Part A:

*The University of New Hampshire
InterOperability Laboratory*

1. The DUT is instructed to transmit a valid frame.
2. The testing station is instructed to create a collision at the DUT ‘*n*’ bits (see Table 4 - 11) after the DUT begins transmission of preamble. The initial value of ‘*n*’ should be 0, although it is also sometimes possible to check for negative values of ‘*n*’ if the transmission from the DUT can be correctly anticipated. Negative values of ‘*n*’ would be when the “colliding” transmission from the testing station occurs on the line before the transmission from the DUT.
3. The activity captured by the testing station is observed.
4. Ideally, steps 1 through 3 are repeated with the value of ‘*n*’ incremented by ‘*x*’ according to Table 4 - 11. Typically, 2 or 3 values of ‘*n*’ are used to test functionality.

Table 4 - 11 Values of “*n*” for test 4.1.1

PHY SPEED	Increment “ <i>n</i> ” by “ <i>x</i> ” bits:	Repeat steps 1 through 3 until “ <i>n</i> ” equals:
≤ 10Mb/s	<i>x</i> = 1	64 bits
100Mb/s	<i>x</i> = 4	
1000Mb/s	<i>x</i> = 8	

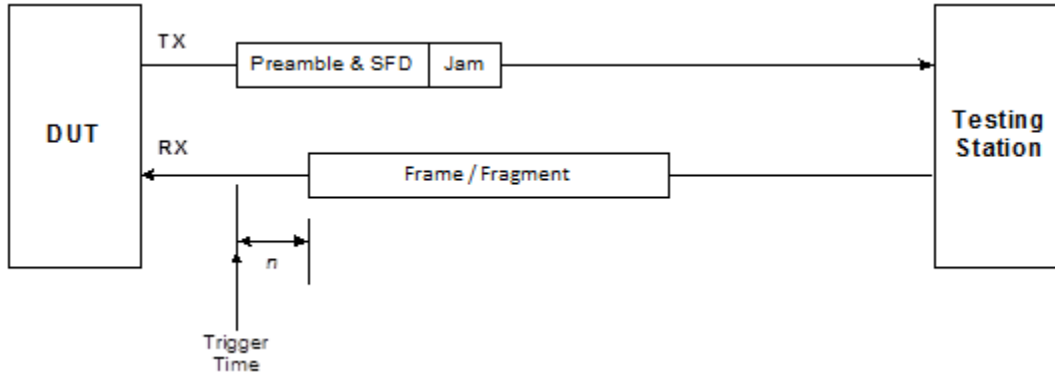

Figure 4 - 7 Timing Diagram for Collisions during preamble or SFD

Part B:

1. The testing station is instructed to monitor the medium for any retransmission attempts from the DUT.

Observable results:

- a. The testing station should capture a collision fragment. This fragment should consist of complete preamble, SFD and a 32-bit jam pattern.
- b. The testing station should capture a complete, valid reply indicating successful retransmission.

Possible Problems:

- It may not be possible to cause a collision during the transmission of preamble due to internal delays within the DUT.

Test #4.4.2 - Collisions After the Reception of SFD within slotTime

Purpose: To verify that the device under test (DUT) detects and enforces collisions that occur during the transmission of data within slotTime.

References:

- [1] IEEE Std 802.3-2012, subclause 4.1.2.2 - Access interference and recovery
- [2] IEEE Std 802.3-2012, subclause 4.2.3.4 - Carrier extension (half duplex mode only)
- [3] IEEE Std 802.3-2012, subclause 4.2.3.2.3 - Collision handling (half duplex mode only)
- [4] IEEE Std 802.3-2012, subclause 4.2.3.2.4 - Collision detection and enforcement (half duplex mode only)
- [5] IEEE Std 802.3-2012, subclause 4.2.3.2.5 - Collision backoff and retransmission (half duplex mode only)
- [6] IEEE Std 802.3-2012, subclause 4.2.4.2.2 - Collision filtering
- [7] IEEE Std 802.3-2012, subclause 4.2.8 - Frame transmission, *procedure* WatchForCollisions
- [8] IEEE Std 802.3-2012, subclause 4.4.2 - MAC parameters
- [9] IEEE Std 802.3-2012, Figure 4-2(a) - Transmit Frame State Diagram
 - (a) 10Mb/s: - 4.4.2
 - (b) 100BASE-X: - 4.4.2 - MAC parameters, 22.2.2.12 - COL (collision detected), 24.2.4.2 - Transmit
 - (c) 1000BASE-X: - 4.4.2 - MAC parameters, 35.2.2.12 - COL (collision detected), and Figure 35-15
 - (d) 1000BASE-T: 4.4.2 - MAC parameters, 40.1.3.1 - Physical coding sublayer (PCS), 40.3.1.3 - PCS transmit function
- [10] [ANNEX A \(informative\) Table of Acronym Definitions](#)
- [11] [ANNEX B \(informative\) Testing Requirements](#)
- [12] [ANNEX C \(informative\) Suggested Test Setups and Configurations](#)

Resource Requirements: A testing station capable of transmitting a frame so that it is received while the DUT is transmitting and capable of monitoring traffic from the DUT.

Last Modification: June 4, 2015

Discussion: In half duplex mode the MAC sublayer monitors collisionDetect while it is transmitting a frame. The collisionDetect signal is generated only during transmission and is never true at any other time; in particular, it cannot be used during frame reception to detect collisions between two or more other stations. If a station is transmitting and the physical layer asserts the collisionDetect signal, then a collision event has occurred.

When a collision occurs during transmission of data, before the completion of the slotTime timer, the station should cease transmission of data and transmit a 32-bit “jam” signal to enforce the collision. The slotTime timer begins with the transmission of the first bit of preamble. The content of the jam is unspecified; it may be any fixed or variable pattern convenient to the media access implementation. The pattern shall not be intentionally designed to be the 32-bit CRC value corresponding to the (partial) frame transmitted prior to the jam. After a collision has occurred during the transmission of data, within slotTime, the DUT should attempt to retransmit the frame.

Test Setup: Connect the device under test (DUT) to the testing station with the appropriate medium (i.e. unshielded twisted pair (UTP), shielded twisted pair (STP), balanced copper, multi-mode fiber, etc.) and transmit a valid frame to the DUT to ensure that the DUT is functioning properly. See [Annex C](#) for suggested test configurations.

Procedure:

*The University of New Hampshire
InterOperability Laboratory*

Part A:

1. The DUT is instructed to transmit a valid frame.
2. The testing station is instructed to create a collision 'n' bits after the DUT transmits the first byte of preamble. The initial value of 'n' should cause a collision in the first byte of frame data after the SFD.
3. The activity captured by the testing station is observed.
4. Ideally, steps 1 through 3 are repeated with the value of 'n' incremented by 'x' until 'n' = slotTime as shown in Table 4 - 12. Typically, 2 or 3 values of 'n' are used to test functionality.

Table 4 - 12 Values of 'n' for test 4.1.2

PHY SPEED	Increment 'n' by 'x' bits:	Repeat steps 1 through 3 until 'n' equals:
≤ 10Mb/s	<i>x</i> = 1	slotTime = 512 bits
100Mb/s	<i>x</i> = 4	
1000Mb/s	<i>x</i> = 8	slotTime = 512 bytes

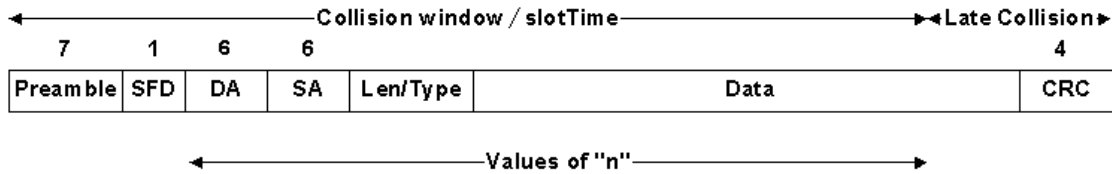

Figure 4 - 8 Collisions after the reception of SFD within slotTime

Part B:

1. The testing station is instructed to monitor the medium for any retransmission attempts from the DUT.

Observable results:

- a. When the value of 'n' is less than slotTime, the testing station should capture a collision fragment. This fragment should consist of complete preamble, SFD, any terminated data transmission and a 32-bit jam pattern. The jam pattern should not intentionally equal the CRC-32 value for the collision fragment.
- b. The testing station should capture a complete, valid reply indicating successful retransmission.

Possible Problems:

- If the jam pattern generated is not a fixed and readily identifiable pattern, it may be difficult to determine how many bits of jam were transmitted.

Test #4.4.3 - Collisions in Data Outside of slotTime while not Bursting

Purpose: To verify that the device under test (DUT) detects and enforces collisions that occur outside of slotTime while not in burst mode or within the first packet in a burst.

References:

- [1] IEEE Std 802.3-2012, subclause 4.1.2.2 - Access interference and recovery
- [2] IEEE Std 802.3-2012, subclause 4.2.3.2.3 - Collision handling (half duplex mode only)
- [3] IEEE Std 802.3-2012, subclause 4.2.3.2.4 - Collision detection and enforcement (half duplex mode only)
- [4] IEEE Std 802.3-2012, subclause 4.2.3.2.5 - Collision backoff and retransmission (half duplex mode only)
- [5] IEEE Std 802.3-2012, subclause 4.2.3.2.7 - Packet bursting (half duplex mode only)
- [6] IEEE Std 802.3-2012, subclause 4.2.3.4 - Carrier extension (half duplex mode only)
- [7] IEEE Std 802.3-2012, subclause 4.2.4.2.2 - Collision filtering
- [8] IEEE Std 802.3-2012, subclause 4.2.8 - Frame transmission, *procedure* WatchForCollisions
- [9] IEEE Std 802.3-2012, subclause 4.2.9 - Frame reception
- [10] IEEE Std 802.3-2012, subclause 4.4.2 - MAC parameters
- [11] IEEE Std 802.3-2012, Figure 4-1 - Relationship among CSMA/CD procedures
- [12] IEEE Std 802.3-2012, Figure 4-2 (a) - Transmit Frame State Diagram
- [13] [ANNEX A \(informative\) Table of Acronym Definitions](#)
- [14] [ANNEX B \(informative\) Testing Requirements](#)
- [15] [ANNEX C \(informative\) Suggested Test Setups and Configurations](#)

Resource Requirements: A testing station capable of transmitting a packet so that it is received while the DUT is transmitting and capable of monitoring traffic from the DUT.

Last Modification: June 4, 2015

Discussion: In half duplex mode the MAC sublayer monitors collisionDetect while it is transmitting a frame. The collisionDetect signal is generated only during transmission and is never true at any other time; in particular, it cannot be used during frame reception to detect collisions between two or more other stations. If a station is transmitting and the physical layer asserts the collisionDetect signal, then a collision event has occurred.

If a collision occurs after slotTime has expired, then the collision is considered to be a late collision. The slotTime timer begins with the transmission of the first bit of preamble. When a late collision occurs the station should cease transmission of data and transmit a 32-bit “jam” signal to enforce the collision. The content of the jam is unspecified; it may be any fixed or variable pattern convenient to the media access implementation. The pattern shall not be intentionally designed to be the 32-bit CRC value corresponding to the (partial) frame transmitted prior to the jam.

At speeds less than 1000 Mb/s, slot time is 64 bytes (512 bits), and any collision that occurs after slotTime expires may be retransmitted.

At 1000 Mb/s, slot time is 512 bytes (4096 bits), and any collision that occurs after slotTime expires shall not be retransmitted.

Test Setup: Connect the device under test (DUT) to the testing station with the appropriate medium (i.e. unshielded twisted pair (UTP), shielded twisted pair (STP), balanced copper, multi-mode fiber, etc.) and transmit a valid packet to the DUT to ensure that the DUT is functioning properly. See [Annex C](#) for suggested test configurations.

Procedure:

Part A:

1. The DUT is instructed to transmit the largest valid frame size supported by the DUT (1518, 1522, or 2000) byte frame.
2. The testing station is then instructed to create a collision 'n' bits into the packet (this includes preamble and SFD). The initial value of 'n' is indicated in Table 4 - 13. The output of the DUT is observed.
3. Ideally, steps 1 and 2 are repeated with the value of 'n' incremented by 'x' from [slotTime + 'x'] to the largest valid frame supported by the DUT. Typically, 2 or 3 values of 'n' are used to test functionality.

Table 4 - 13 Initial value for "n" for test 4.4.3

PHY SPEED	slotTime	Initial value of 'n'	Value of 'x'
≤ 10Mb/s	512 bits (64 bytes)	513 bits	1 bit
100Mb/s		516 bits	4 bits
1000Mb/s	4096 bits (512 bytes)	513 bytes	1 byte

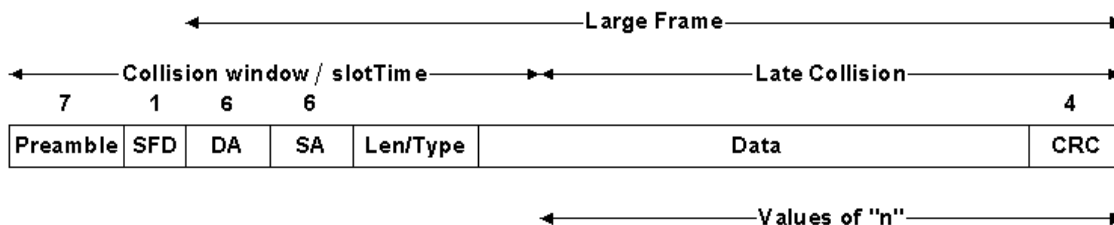

Figure 4 - 9 Collisions in data after slotTime

Part B:

1. The testing station is instructed to monitor the medium for any retransmission attempts from the DUT.

Observable results:

- a. The testing station should capture a collision fragment. This fragment should consist of complete preamble, SFD, any terminated data transmission and a 32-bit jam pattern. The jam pattern should not intentionally equal the CRC-32 value for the collision fragment.
- b. Any packets that are involved in a late collision should be detected by the DUT and may be retransmitted for speeds less than 1000 Mb/s, but not retransmitted for speeds equal to 1000 Mb/s.

Possible Problems:

- If the jam pattern generated is not a fixed and readily identifiable pattern, it may be difficult to determine how many bits of jam were transmitted.

The University of New Hampshire
InterOperability Laboratory

Test #4.4.4 - Collisions During Extension within slotTime

Purpose: To verify that the device under test (DUT) detects and enforces collisions that occur during carrier extension within slotTime.

References:

- [1] IEEE Std 802.3-2012, subclause 4.1.2.2 - Access interference and recovery
- [2] IEEE Std 802.3-2012, subclause 4.2.3.2.3 - Collision handling (half duplex mode only)
- [3] IEEE Std 802.3-2012, subclause 4.2.3.2.4 - Collision detection and enforcement (half duplex mode only)
- [4] IEEE Std 802.3-2012, subclause 4.2.3.2.5 - Collision backoff and retransmission (half duplex mode only)
- [5] IEEE Std 802.3-2012, subclause 4.2.3.4 - Carrier extension (half duplex mode only)
- [6] IEEE Std 802.3-2012, subclause 4.2.4.2.2 - Collision filtering
- [7] IEEE Std 802.3-2012, subclause 4.2.8 - Frame transmission, *procedure* WatchForCollisions
- [8] IEEE Std 802.3-2012, Figure 4-2 (a) - Transmit Frame State Diagram
 - (a) 1000BASE-X: - 35.2.2.12 - COL (Collision detection), 35.2.3.5 - Carrier extension and Figures 35-15, 35-16
 - (a) 1000BASE-T: 4.4.2 - MAC parameters, 40.1.3.1 - Physical coding sublayer (PCS), 40.3.1.3 - PCS transmit function
- [9] [ANNEX A \(informative\) Table of Acronym Definitions](#)
- [10] [ANNEX B \(informative\) Testing Requirements](#)
- [11] [ANNEX C \(informative\) Suggested Test Setups and Configurations](#)

Resource Requirements: A testing station capable of transmitting a frame so that it is received while the DUT is transmitting and capable of monitoring traffic from the DUT.

Last Modification: June 4, 2015

Discussion: In half duplex mode the MAC sublayer monitors collisionDetect while it is transmitting a frame. The collisionDetect signal is generated only during transmission and is never true at any other time; in particular, it cannot be used during frame reception to detect collisions between two or more other stations. If a station is transmitting and the physical layer asserts the collisionDetect signal, then a collision event has occurred.

In half-duplex mode at 1000 Mb/s, the slotTime employed at slower speeds is inadequate to accommodate network topologies of the desired physical extent. Carrier extension provides a means by which the slotTime can be increased to a sufficient value for the desired topologies, without increasing the minFrameSize parameter. Non-data bits, referred to as extension bits, are appended to frames which are less than slotTime bits in length so that the resulting transmission is at least one slotTime in duration. The maximum length of the extension is equal to the quantity, (slotTime – minFrameSize).

The MAC continues to monitor the medium for collisions during the transmission extension bits. When a collision occurs during the transmission of extension within slotTime, the station should cease transmission of extension and transmit a 32-bit jam signal to enforce the collision. The slotTime timer begins with the transmission of the first bit of preamble. The content of the jam must be extensionErrorBits. After a collision has occurred during the transmission of extension bits, within data, the DUT should attempt to retransmit the frames

Test Setup: Connect the device under test (DUT) to the testing station with the appropriate medium (i.e. unshielded twisted pair (UTP), shielded twisted pair (STP), balanced copper, multi-mode fiber, etc.) and

*The University of New Hampshire
InterOperability Laboratory*

transmit a valid frame to the DUT to ensure that the DUT is functioning properly. See [Annex C](#) for suggested test configurations.

*The University of New Hampshire
InterOperability Laboratory*

Procedure:

Part A:

1. The DUT is instructed to transmit a valid 64 byte frame with 448 bytes of extension.
2. The testing station is instructed to create a collision 'n' octets after the DUT transmits the first byte of preamble. The initial value of 'n' should be 73. This should cause a collision to occur when the DUT is transmitting carrier extension.
3. The output of the DUT is observed.
4. Ideally, steps 1 through 3 are repeated with the value of 'n' incremented from 73 to slotTime (512 bytes). Typically, 2 or 3 values of 'n' are used to test functionality.

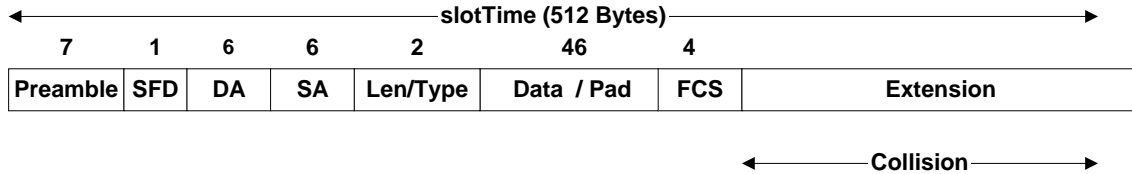

Figure 4 - 10 Collisions during extension within slotTime

Part B:

1. The testing station is instructed to capture any retransmission attempts from the DUT.

Observable results:

- a. The testing station should capture a collision fragment. This fragment should consist of complete preamble, SFD, complete data, any transmitted extension bits and a 32-bit jam pattern consisting of extension error bits.
- b. The testing station should capture a complete, valid reply indicating a successful retransmission.

Possible Problems: None

The University of New Hampshire
InterOperability Laboratory

Test #4.4.5 - Collisions During Preamble and SFD Outside of slotTime (Burst Mode).

Purpose: To verify that the device under test (DUT) detects and enforces collisions that occur during the transmission of preamble and SFD outside of slotTime (in burst mode).

References:

- [1] IEEE Std 802.3-2012, subclause 4.1.2.2 - Access interference and recovery
- [2] IEEE Std 802.3-2012, subclause 4.2.3.2.3 - Collision handling (half duplex mode only)
- [3] IEEE Std 802.3-2012, subclause 4.2.3.2.4 - Collision detection and enforcement (half duplex mode only)
- [4] IEEE Std 802.3-2012, subclause 4.2.3.2.5 - Collision backoff and retransmission (half duplex mode only)
- [5] IEEE Std 802.3-2012, subclause 4.2.3.4 - Carrier extension (half duplex mode only)
- [6] IEEE Std 802.3-2012, subclause 4.2.4.2.2 - Collision filtering
- [7] IEEE Std 802.3-2012, subclause 4.2.8 - Frame transmission, *procedure* WatchForCollisions
- [8] IEEE Std 802.3-2012, Figure 4-1 - Relationship among CSMA/CD procedures
- [9] IEEE Std 802.3-2012, Figure 4-2 (a) - Transmit Frame State Diagram
 - (a) 1000BASE-X: - 35.2.2.12 - COL (Collision detection), 35.2.3.5 - Carrier extension and Figures 35-15, 35-16
 - (b) 1000BASE-T: 4.4.2 - MAC parameters, 40.1.3.1 - Physical coding sublayer (PCS), 40.3.1.3 - PCS transmit function
- [10] [ANNEX A \(informative\) Table of Acronym Definitions](#)
- [11] [ANNEX B \(informative\) Testing Requirements](#)
- [12] [ANNEX C \(informative\) Suggested Test Setups and Configurations](#)

Resource Requirements: A testing station capable of transmitting a packet so that it is received while the DUT is transmitting and capable of monitoring traffic from the DUT.

Last Modification: June 5, 2015

Discussion: In half-duplex mode at 1000 Mb/s, an implementation may optionally transmit a series of frames without relinquishing control of the transmission medium. This mode of operation is referred to as burst mode. The first frame of a burst must always be at least slotTime in length (4096 bits), which may be accomplished through the addition of extension bits. Once this first packet has been successfully transmitted, the transmitting station can begin transmission of another packet without contending for the medium. Other stations on the network will continue to defer to its transmission, provided that the transmitting station does not allow the medium to assume an idle condition between packets. To do this the transmitting station fills the interpacket spacing interval with extension bits in order to maintain control of the medium. The transmitting station is allowed to initiate frame transmission until a specified limit, referred to as burstLimit, is reached. The value of burstLimit is specified in clause 4.4.2.

In a properly configured network, and in the absence of errors, collisions cannot occur during a burst at any time after the first frame of a burst has been transmitted. Therefore, the MAC will treat all collisions that occur after the first packet of a burst as a late collision. Within a burst of frames, the first frame of a burst must be at least slotTime bits in length in order to be accepted by the receiver, while subsequent frames within a burst must be at least minFrameSize in length. Anything less is presumed to be a fragment resulting from a collision, and is discarded by the receiver. The discarding of such a fragment by a MAC is not reported as an error.

The MAC continues to monitor the medium for collisions for the duration of the burst. If a collision occurs during the transmission of preamble or SFD outside of slotTime, the station should finish transmission of preamble and SFD and transmit a 32-bit jam signal to enforce the collision. The slotTime timer begins with the

*The University of New Hampshire
InterOperability Laboratory*

transmission of the first bit of preamble. The content of the jam is unspecified; it may be any fixed or variable pattern convenient to the media access implementation. The pattern shall not be intentionally designed to be the 32-bit CRC value corresponding to the (partial) frame transmitted prior to the jam. Any collision that occurs during any frame, other than the first, within a burst is a late collision and should, therefore, not be retransmitted.

Test Setup: Connect the device under test (DUT) to the testing station with the appropriate medium (i.e. unshielded twisted pair (UTP), shielded twisted pair (STP), balanced copper, multi-mode fiber, etc.) and transmit a valid frame to the DUT to ensure that the DUT is functioning properly. See [Annex C](#) for suggested test configurations.

Procedure:

Part A:

1. The DUT is instructed to transmit a burst consisting of ten valid 64 byte frames. Ideally, each frame should have a sequence number to facilitate the observation phase. The first frame will be extended to slotTime (4096 bits). Each packet within the burst should be separated by 12 bytes of IPG consisting of carrier extension. This will yield a carrier event of 1288 bytes (532 + [9 * 84]).
2. The testing station is instructed to create a collision (532 + n + [m * 84]) octets after the DUT transmits the SPD. Initially 'n' and 'm' are set to zero. This will cause a collision to occur during the preamble of the second frame. The position is indicated by the arrow "A".
3. The output of the DUT is observed.
4. Ideally, steps 1 through 3 are repeated with the value of 'n' incremented from 0 to 7. When n is set to 8, the collision will occur during the transmission of SFD, which is indicated by the arrow "B". Typically, 1 or 2 values of 'n' are used to test functionality.
5. Ideally, steps 1 through 4 are repeated with the value of 'I' incremented for 0 to 8. This will test collisions in preamble and SFD in all the packets transmitted during the Burst. Arrows "Y" and "Z" indicate the final testing positions. Typically, 2 or 3 values of 'm' are used to test functionality.

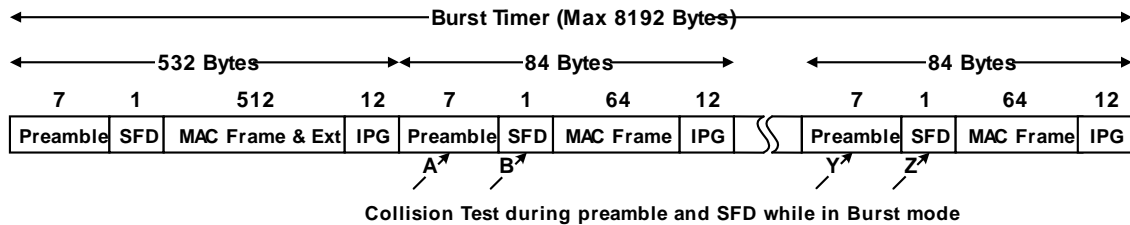

Figure 4 - 11 Collisions during preamble and SFD outside of slotTime (Burst Mode)

Part B:

1. The testing station is instructed to capture any retransmission attempts from the DUT.

Observable results:

- a. The testing station should capture a complete valid packet for all complete packets transmitted during the burst, prior to the collision. The number of these additional valid packets should equal the value of 'm'. The sequence numbers of the frames should be checked to verify that the correct frames were received. The testing station should then capture a collision fragment that indicates a collision occurring during preamble or SFD. This fragment should consist of complete preamble, SFD and a 32-bit jam pattern. The jam pattern should not intentionally equal the CRC-32 value for the collision fragment.

The University of New Hampshire
InterOperability Laboratory

- b. After the collision, the DUT should cease transmitting in burst mode and the DUT should not retransmit the packet involved in the collisions. The testing station should receive a total of nine packets and one collision.

Possible Problems:

- If the jam pattern generated is not a fixed and readily identifiable pattern, it may be difficult to determine how many bits of jam were transmitted.
- Bursting is optional so some devices may not support it.
- It may be difficult to force the DUT to transmit in burst mode.
- Due to internal delays within the DUT, even though a collision may be present at a specific point at the MDI of the DUT the MAC layer of the DUT may not recognize the occurrence of a collision and begin transmission of jam until up to 440 bit times later into the transmission for either 1000BASE-X (IEEE 802.3 Table 36-18) or 1000BASE-T (IEEE 802.3 Table 40-15).

Test #4.4.6 - Collisions During Data Outside of slotTime (Burst Mode)

Purpose: To verify that the device under test (DUT) detects and enforces collisions occurring during the transmission of data outside of slotTime and within a burst.

References:

- [1] IEEE Std 802.3-2012, subclause 4.1.2.2 - Access interference and recovery
- [2] IEEE Std 802.3-2012, subclause 4.2.3.2.3 - Collision handling (half duplex mode only)
- [3] IEEE Std 802.3-2012, subclause 4.2.3.2.4 - Collision detection and enforcement (half duplex mode only)
- [4] IEEE Std 802.3-2012, subclause 4.2.3.2.5 - Collision backoff and retransmission (half duplex mode only)
- [5] IEEE Std 802.3-2012, subclause 4.2.3.2.7 - Packet bursting (half duplex mode only)
- [6] IEEE Std 802.3-2012, subclause 4.2.3.4 - Carrier extension (half duplex mode only)
- [7] IEEE Std 802.3-2012, subclause 4.2.4.2.2 - Collision filtering
- [8] IEEE Std 802.3-2012, subclause 4.2.8 - Frame transmission, procedure WatchForCollisions
- [9] IEEE Std 802.3-2012, subclause 4.2.9 - Frame reception
- [10] IEEE Std 802.3-2012, subclause 4.4.2 - MAC parameters
- [11] IEEE Std 802.3-2012, Figure 4-1 - Relationship among CSMA/CD procedures
- [12] IEEE Std 802.3-2012, Figure 4-2 (a) - Transmit Frame State Diagram
 - (a) 1000BASE-X: - 35.2.2.12 - COL (Collision detection), 35.2.3.5 - Carrier extension and Figures 35-15, 35-16
 - (c) 1000BASE-T: 4.4.2 - MAC parameters, 40.1.3.1 - Physical coding sublayer (PCS), 40.3.1.3 - PCS transmit function
- [13] ANNEX A (informative) Table of Acronym Definitions
- [14] ANNEX B (informative) Testing Requirements
- [15] ANNEX C (informative) Suggested Test Setups and Configurations

Resource Requirements: A testing station capable of transmitting a frame so that it is received while the DUT is transmitting and capable of monitoring traffic from the DUT.

Last Modification: June 5, 2015

Discussion: In half-duplex mode at 1000 Mb/s, an implementation may optionally transmit a series of frames without relinquishing control of the transmission medium. This mode of operation is referred to as burst mode. The first frame of a burst must always be at least slotTime in length (4096 bits), which may be accomplished through the addition of extension bits. Once this first frame has been successfully transmitted, the transmitting station can begin transmission of another frame without contending for the medium. Other stations on the network will continue to defer to its transmission, provided that the transmitting station does not allow the medium to assume an idle condition between frames. To do this the transmitting station fills the interPacket spacing interval with extension bits in order to maintain control of the medium. The transmitting station is allowed to initiate frame transmission until a specified limit, referred to as burstLimit, is reached. The value of burstLimit is specified in clause 4.4.2.

In a properly configured network, and in the absence of errors, collisions cannot occur during a burst at any time after the first frame of a burst has been transmitted. Therefore, the MAC will treat all collisions that occur after the first frame of a burst as a late collision. Within a burst of frames, the first frame of a burst must be at least slotTime bits in length in order to be accepted by the receiver, while subsequent frames within a burst must be at least minFrameSize in length. Anything less is presumed to be a fragment resulting from a collision, and is discarded by the receiver. The discarding of such a fragment by a MAC is not reported as an error.

*The University of New Hampshire
InterOperability Laboratory*

The MAC continues to monitor the medium for collisions for the duration of the burst. If a collision occurs during the transmission of data outside of slotTime, the station should cease transmission of data and transmit a 32-bit jam signal to enforce the collision. The slotTime timer begins with the transmission of the first bit of preamble. The content of the jam is unspecified; it may be any fixed or variable pattern convenient to the media access implementation. The pattern shall not be intentionally designed to be the 32-bit CRC value corresponding to the (partial) frame transmitted prior to the jam. Any collision that occurs during any packet, other than the first, within a burst is a late collision and should, therefore, not be retransmitted.

Test Setup: Connect the device under test (DUT) to the testing station with the appropriate medium (i.e. unshielded twisted pair (UTP), shielded twisted pair (STP), balanced copper, multi-mode fiber, etc.) and transmit a valid packet to the DUT to ensure that the DUT is functioning properly. See [Annex C](#) for suggested test configurations.

Procedure:

Part A:

1. The DUT is instructed to transmit 10 valid 64 byte frames. Ideally, each frame should have a sequence number to facilitate the observation phase. The first frame will be extended to slotTime (4096 bits). Each packet within the burst should be separated by 12 byte of IPG consisting of carrier extension. This will yield a carrier event of 1288 bytes ($532 + [9 * 84]$).
2. The testing station is instructed to create a collision ($532 + n + [m * 84]$) octets after the DUT transmits the first byte of preamble. Initially 'n' is set to 8 and 'm' is set to zero. This will cause a collision to occur during the data portion of the second frame. The arrow "A" indicates the position.
3. The output of the DUT is observed.
4. Ideally, steps 1 through 3 are repeated with the value of 'n' incremented from 8 to 63. This should cause a collision to occurring during each byte of data within the frame. Typically, 1 or 2 values of 'n' are used to test functionality.
5. Finally steps 1 through 4 are repeated with the value of 'm' incremented from 0 to 8. This will test collisions in data portion in all the frames sent during the Burst. The arrow "Z" indicates the final testing position.

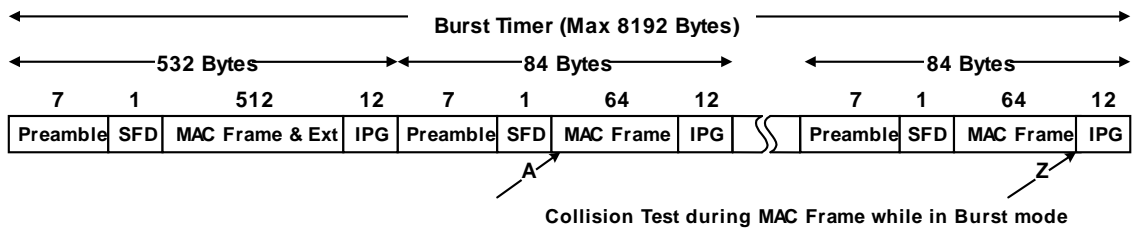

Figure 4 - 32 Collisions during data outside of slotTime (Burst Mode)

Part B:

1. The testing station is instructed to capture any retransmission attempts from the DUT.

Observable results:

- a. The testing station should capture a complete valid frame for all complete packets transmitted during the burst, prior to the collision. The number of these additional valid packets should equal the value of 'm'. The sequence numbers of the packets should be checked to verify that the correct packets were received. The testing station should then capture a collision fragment that indicates a collision occurring during the transmission of data. This fragment should consist of complete preamble, SFD, all data transmitted prior to the collision and a 32-bit jam pattern. The jam pattern should not intentionally equal the CRC-32 value for the collision fragment.

*The University of New Hampshire
InterOperability Laboratory*

- b. After the collision, the DUT should cease transmitting in burst mode and the DUT should not retransmit the packet involved in the collisions. The testing station should receive a total of nine packets and one collision.

Possible Problems:

- If the jam pattern generated is not a fixed and readily identifiable pattern, it is difficult to determine how many bits of jam were transmitted.
- It may be difficult to force the DUT to transmit in burst mode.
- Due to internal delays within the DUT, even though a collision may be present at a specific point at the MDI of the DUT the MAC layer of the DUT may not recognize the occurrence of a collision and begin transmission of jam until up to 440 bit times later into the transmission for either 1000BASE-X (IEEE 802.3 Table 36-18) or 1000BASE-T (IEEE 802.3 Table 40-15).

Test #4.4.7 - Collisions During IPG within a Burst

Purpose: To verify that the device under test (DUT) detects and enforces collisions that occur in the interPacket spacing between packets in a burst.

References:

- [1] IEEE Std 802.3-2012, subclause 4.1.2.2 - Access interference and recovery
- [2] IEEE Std 802.3-2012, subclause 4.2.3.2.3 - Collision handling (half duplex mode only)
- [3] IEEE Std 802.3-2012, subclause 4.2.3.2.4 - Collision detection and enforcement (half duplex mode only)
- [4] IEEE Std 802.3-2012, subclause 4.2.3.2.5 - Collision backoff and retransmission (half duplex mode only)
- [5] IEEE Std 802.3-2012, subclause 4.2.3.2.7 - Packet bursting (half duplex mode only)
- [6] IEEE Std 802.3-2012, subclause 4.2.3.4 - Carrier extension (half duplex mode only)
- [7] IEEE Std 802.3-2012, subclause 4.2.4.2.2 - Collision filtering
- [8] IEEE Std 802.3-2012, subclause 4.2.8 - Frame transmission, procedure WatchForCollisions
- [9] IEEE Std 802.3-2012, subclause 4.2.9 - Frame reception
- [10] IEEE Std 802.3-2012, subclause 4.4.2 - MAC parameters
- [11] IEEE Std 802.3-2012, Figure 4-1 - Relationship among CSMA/CD procedures
- [12] IEEE Std 802.3-2012, Figure 4-2 (a) - Transmit Frame State Diagram
 - (a) 1000BASE-X: - 35.2.2.12 - COL (Collision detection), 35.2.3.5 - Carrier extension and Figures 35-15, 35-16
 - (b) 1000BASE-T: 4.4.2 - MAC parameters, 40.1.3.1 - Physical coding sublayer (PCS), 40.3.1.3 - PCS transmit function
- [13] [ANNEX A \(informative\) Table of Acronym Definitions](#)
- [14] [ANNEX B \(informative\) Testing Requirements](#)
- [15] [ANNEX C \(informative\) Suggested Test Setups and Configurations](#)

Resource Requirements: A testing station capable of transmitting a packet so that it is received while the DUT is transmitting and capable of monitoring traffic from the DUT.

Last Modification: June 5, 2015

Discussion: In half-duplex mode at 1000 Mb/s, an implementation may optionally transmit a series of packets without relinquishing control of the transmission medium. This mode of operation is referred to as burst mode. The first frame of a burst must always be at least slotTime in length (4096 bits), which may be accomplished through the addition of extension bits. Once this first packet has been successfully transmitted, the transmitting station can begin transmission of another packet without contending for the medium. Other stations on the network will continue to defer to its transmission, provided that the transmitting station does not allow the medium to assume an idle condition between packets. To do this the transmitting station fills the interPacket spacing interval with extension bits in order to maintain control of the medium. The transmitting station is allowed to initiate packet transmission until a specified limit, referred to as burstLimit, is reached. The value of burstLimit is specified in clause 4.4.2.

The MAC continues to monitor the medium for collisions for the duration of the burst. The receiving station accepts each complete packet in a burst individually. If a collision occurs in the IPG, within a burst, then the packet transmitted prior to it should be accepted and a 32-bit jam pattern, consisting of extension error bits, should be transmitted. If there was a packet waiting to be sent, its transmission should be deferred for at least minimum interPacket Spacing and follow normal deference rules. Also burst mode should be discontinued.

*The University of New Hampshire
InterOperability Laboratory*

Test Setup: Connect the device under test (DUT) to the testing station with the appropriate medium (i.e. unshielded twisted pair (UTP), shielded twisted pair (STP), balanced copper, multi-mode fiber, etc.) and transmit a valid packet to the DUT to ensure that the DUT is functioning properly. See [Annex C](#) for suggested test configurations.

Procedure:

Part A:

1. The DUT is instructed to transmit 10 valid 64 byte frames. Ideally, each frame should have sequence numbers to facilitate in the observation phase. The first frame will be extended to slotTime (4096 bits). Each packet within the burst should be separated by 12 bytes of IPG consisting of carrier extension. This will yield a carrier event of 1288 bytes ($532 + [9 * 84]$).
2. The testing station is instructed to create a collision at the DUT ($532 + n + [m * 84]$) octets after the DUT transmits the first byte of preamble. Initially 'n' is set to 72 and 'm' is set to zero. This will cause a collision to occur during the interPacket spacing after the second packet in the burst. Arrow 'A' indicates the position.
3. The output of the DUT is observed.
4. Ideally, steps 1 through 3 are repeated with the value of 'n' incremented from 72 to 84. This should cause a collision during each byte of IPG. Typically, 1 or 2 values of 'n' are used to test functionality.
5. Finally steps 1 through 4 are repeated with the value of 'm' incremented from 0 to 8. This will test collisions in the IPG between each of the packets in the burst. Arrow 'Z' indicates the final testing position.

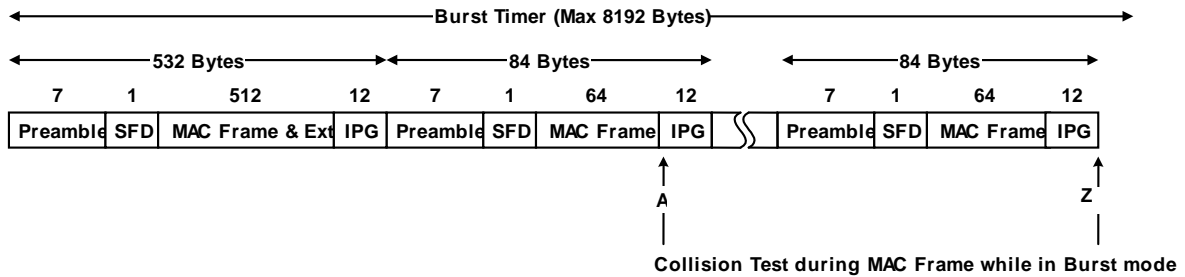

Figure 4 - 13 Collisions during IPG outside of slot time (Burst Mode)

Observable results:

- a. The testing station should receive each packet transmitted by the DUT. The DUT should discontinue transmitting in burst mode after each collision. The DUT may transmit the packets after the collision in a separate burst or individually.

Possible Problems:

- Some devices may not support bursting.
- It may be difficult to force the DUT to transmit in burst mode.
- It may be difficult to cause a collision at this point at the MAC as due to internal delays within the DUT, even though a collision may be present at a specific point at the MDI of the DUT the MAC layer of the DUT may not recognize the occurrence of a collision and begin transmission of jam until up to 440 bit times later into the transmission for either 1000BASE-X (IEEE 802.3 Table 36-18) or 1000BASE-T (IEEE 802.3 Table 40-15).

GROUP 5: Deference Process

Scope: The following tests cover MAC operations specific to deference process.

Overview: These tests are designed to verify that the device under test properly defers to carrier sense. The MAC functions explored are defined in Clause 4 of IEEE 802.3.

*The University of New Hampshire
InterOperability Laboratory*

Test #4.5.1 - Defer to Carrier Sense while Frame Waiting

Purpose: To verify that the device under test (DUT) defers to the carrier sense signal when it has a frame waiting to be sent.

References:

- [1] IEEE Std 802.3-2012, subclause 4.1.2.1.1 - Transmission without contention
- [2] IEEE Std 802.3-2012, subclause 4.2.3.2.1 - Deference
- [3] IEEE Std 802.3-2012, subclause 4.2.8 - Frame transmission, *process* Deference
- [4] IEEE Std 802.3-2012, subclause 5.2.4 - DTE Management procedural model
- [5] IEEE Std 802.3-2012, subclause 30.3.1.1.20, aFramesWithExcessiveDeferral
- [6] IEEE Std 802.3-2012, Figure 4A-2c
- [7] [ANNEX A \(informative\) Table of Acronym Definitions](#)
- [8] [ANNEX B \(informative\) Testing Requirements](#)
- [9] [ANNEX C \(informative\) Suggested Test Setups and Configurations](#)

Resource Requirements: A testing station capable of generating traffic and capable of capturing packets with precise timestamps. MDI, AUI, MII, GMII or PCS access and or control by the testing station are ideal.

Last Modification: November 9, 2015

Discussion: The physical layer monitors the medium and when a carrier event is detected it provides carrier sense signaling to the MAC layer. In the event that carrier sense is indicated while a packet is in waiting, the DUT should delay the transmission of the packet until carrier sense is de-asserted.

If a device defers for InterPacketGap (IPG) and carrier sense is not asserted (no traffic is being detected) the MAC may transmit a packet waiting to be transmitted. A device must defer for at least one IPG in order to allow recovery time for other devices on the network.

Test Setup: Connect the device under test (DUT) to the testing station with the appropriate medium (i.e. unshielded twisted pair (UTP), shielded twisted pair (STP), balanced copper, multi-mode fiber, etc.) and transmit a valid packet to the DUT to ensure that the DUT is functioning properly. See [Annex C](#) for suggested test configurations.

Procedure:

Part A:

1. The testing station is instructed to transmit a valid packet, a gap and then a long carrier event of 'n' bytes. The initial value of 'n' should be of sufficient length to determine whether or not deference has occurred. The gap should be chosen so as the carrier event will occur prior to the reply by long enough that a conformant device will not collide with the carrier event.
2. Step 1 is repeated and the value of 'n' is incremented by 'x'.
3. Ideally steps 1 and 2 are repeated until 'n' is equal to jabber size in length and a consistent response pattern has been established. Typically several values will be chosen for 'x'.

Table 4 - 14 Values for Test 4.5.1

	Initial value for 'n'	Ideal Values for 'x'	Actual Values for 'x'	Minimum Jabber Size
10Mb/s	'n' = 64 bytes	'x' = 1 bit	'x' = 100 bytes	75,000 bits
100Mb/s	'n' = 64 bytes	'x' = 4 bits		
1000Mb/s	'n' = 512 bytes	'x' = 8 bits	'x' = 1000 bytes	150,000 bits

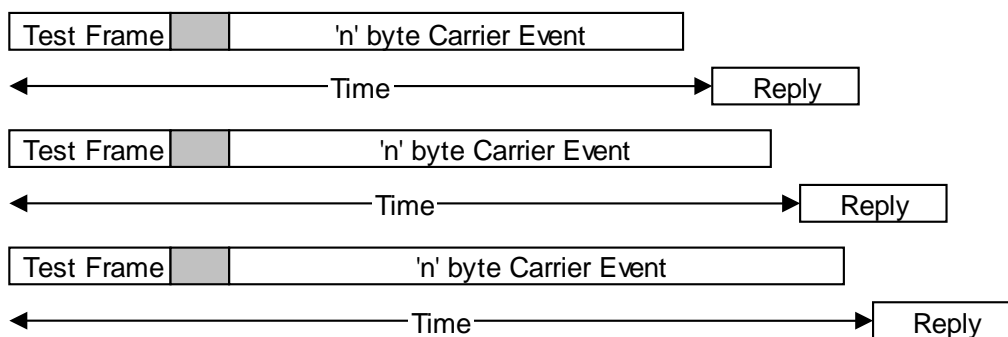

Figure 4 - 44 Defer to carrier sense while frame waiting

Observable Results:

- a. The time difference between the transmission of the last bit of the valid packet and the reception of the first bit of the reply from the DUT is measured and recorded as Δt . If Δt is greater than the length of the long carrier event plus the length of the test packet and the gap then the DUT deferred to carrier sense. Each time the value of 'n' is incremented by 'x', there should be a consistent increase in Δt . This verifies that the delay is due to deference and not to delays in the medium.

Possible Problems:

- Some devices may require a long time to generate a reply to the test frame.
- While the DUT may log the optional clause 30 error, "aFrameWithExcessiveDeferral", after it has deferred for 3036 bytes for 10Mb/s and 100Mb/s, or 19422 bytes for 1000Mb/s. Logging this error shall not affect MAC functionality.
- **100BASE-TX:** Even though the maximum jabber event is defined to be 75000 bits, an issue may occur before this maximum number of bits can be transmitted to the DUT. The receive descrambler of the DUT may lose synchronization during the reception of a jabber event. This is acceptable to occur if more than 361 μ S passes without receiving at least 29 consecutive plaintext idle pattern bits. It is also acceptable to occur if more than 722 μ S passes without receiving at least 58 consecutive plaintext idle pattern bits. Refer to the ANSI X3T9.5 TP-PMD standard in section 7.2.3.3 "Loss of Synchronization". So when testing for longer deferrals it may be necessary to break the larger carrier event up into smaller portions to avoid losing synchronization. However because `interPacketGapPart1` can take any value from 0 to 64 bits it may not be possible to observe deference to carrier events exceeding 361 μ S.

*The University of New Hampshire
InterOperability Laboratory*

Test #4.5.2 - Deference After Collision

Purpose: To verify that the device under test (DUT) continues to observe the deference process when it attempts to retransmit after a collision, which occurred within slotTime.

References:

- [1] IEEE Std 802.3-2012, subclause 4.1.2.1.1 - Transmission without contention
- [2] IEEE Std 802.3-2012, subclause 4.2.3.2.1 - Deference
- [3] IEEE Std 802.3-2012, subclause 4.2.3.2.3 - Collision handling (half duplex mode only)
- [4] IEEE Std 802.3-2012, subclause 4.2.3.2.4 - Collision detection and enforcement (half duplex mode only)
- [5] IEEE Std 802.3-2012, subclause 4.2.8 - Frame transmission
- [6] IEEE Std 802.3-2012, subclause 4.4.2 - MAC parameters, process Deference
- [7] IEEE Std 802.3-2012, subclause 30.3.1.1.20, aFramesWithExcessiveDeferral
- [8] IEEE Std 802.3-2012, Figure 4-3b - Deference process
- [9] ANNEX A (informative) Table of Acronym Definitions
- [10] ANNEX B (informative) Testing Requirements
- [11] ANNEX C (informative) Suggested Test Setups and Configurations

Resource Requirements: A testing station capable of generating traffic and capable of capturing frames with precise timestamps. MDI, AUI, MII, GMII or PCS access and or control by the testing station are ideal.

Last Modification: November 9, 2015

Discussion: The physical layer monitors the medium and in the case of a collision it provides collision detect signal. In the event of a collision detect signal the DUT should cease transmitting and “BackOff” for a random amount of time before attempting to retransmit the frame involved in the collision. If the medium is idle after the DUT has backed off then it may attempt to retransmit the frame. If, however, carrier is detected on the media, the DUT must defer to the station that has control of the media, thus delaying the retransmission of the frame for the duration of the carrier event plus InterPacketGap.

Test Setup: Connect the device under test (DUT) to the testing station with the appropriate medium (i.e. unshielded twisted pair (UTP), shielded twisted pair (STP), balanced copper, multi-mode fiber, etc.) and transmit a valid frame to the DUT to ensure that the DUT is functioning properly. See [Annex C](#) for suggested test configurations.

Procedure:

Part A:

1. The DUT is instructed to transmit a valid frame.
2. When the testing station detects the packet on its receiver it is instructed to transmit a long carrier event of ‘n’ bytes (see Table 4 - 15).
3. Ideally the value ‘n’ should be incremented by ‘x’ (according to Table 4 - 15) and steps 1 and 2 should be repeated until a consistent pattern of increasing response times can be established. Typically several values will be chosen.

Table 4 - 15 Values of ‘n’ and ‘x’ for Test 4.5.2

	Initial value for ‘n’	Ideal Values for ‘x’	Typical Values for ‘x’	Minimum Jabber Size
10Mb/s	‘n’ = 64 bytes	‘x’ = 1 bit	‘x’ = 100 bytes	75,000 bits

*The University of New Hampshire
InterOperability Laboratory*

100Mb/s	'n' = 64 bytes	'x' = 4 bits		
1000Mb/s	'n' = 512 bytes	'x' = 8 bits	'x' = 1000 bytes	150,000 bits

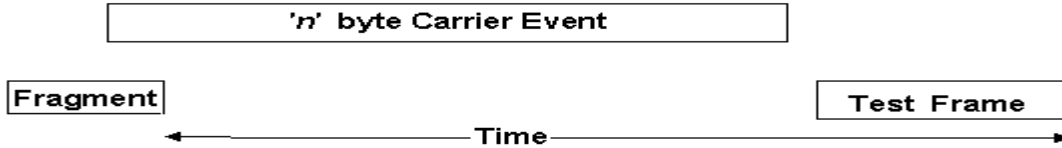

Figure 4 - 55 Deference after collision

Observable Results:

- a. The time difference between the transmission of the last bit of the valid frame and the reception of the first bit of the reply from the DUT is measured and recorded as Δt . The time difference (Δt) between the reception of the collision fragment and the retransmission of the DUT reply can also be observed. Each time the value of 'n' is incremented by 'x', there should be a consistent increase in Δt . This verifies that the delay is due to deference and not to delays in the medium.

Possible Problems:

- Some devices may require a long time to generate a reply to the test frame.
- While the DUT may log the optional clause 30 error, "aFrameWithExcessiveDeferral", after it has deferred for 3036 bytes for 10Mb/s and 100Mb/s, or 19422 bytes for 1000Mb/s. Logging this error shall not affect MAC functionality.
- **100BASE-TX:** Even though the maximum jabber event is defined to be 75000 bits, an issue may occur before this maximum number of bits can be transmitted to the DUT. The receive descrambler of the DUT may lose synchronization during the reception of a jabber event. This is acceptable to occur if more than 361 μ S passes without receiving at least 29 consecutive plaintext idle pattern bits. It is also acceptable to occur if more than 722 μ S passes without receiving at least 58 consecutive plaintext idle pattern bits. Refer to the ANSI X3T9.5 TP-PMD standard in section 7.2.3.3 "Loss of Synchronization". So when testing for longer deferrals it may be necessary to break the larger carrier event up into smaller portions to avoid losing synchronization. However because `interPacketGapPart1` can take any value from 0 to 64 bits it may not be possible to observe deference to carrier events exceeding 361 μ S.

*The University of New Hampshire
InterOperability Laboratory*

Test #4.5.3 – InterPacketGapPart1 Timing

Purpose: To verify that the device under test (DUT) observes the 2/3 rule for InterPacketGap.

References:

- [1] IEEE Std 802.3-2012, subclause 4.1.2.1.1 - Transmission without contention
- [2] IEEE Std 802.3-2012, subclause 4.1.2.1.1 - Transmission without contention
- [3] IEEE Std 802.3-2012, subclause 4.2.3.2.1 - Deference
- [4] IEEE Std 802.3-2012, subclause 4.2.3.2.2 - Interpacket gap, Figure 4-3b - Deference process and 4.2.8 *process* Deference
 - (a) 10Mb/s: 7.2.1.1.2 - output_idle message
 - (b) 100BASE-X: 22.2.3.1 - Inter-frame, Table 24-1, 24.6.3
 - (c) 100BASE-X: 36.2.4.14 - Start_of_packet (SPD) delimiter, Table 36-3, 36.5.3
 - (d) 100BASE-T: 40.3.1.3 - PCS Transmit function, 7.2.1.1.2 - output_idle message, 40.11.3 - Carrier de-assertion/assertion constraint (half duplex mode)
- [5] [ANNEX A \(informative\) Table of Acronym Definitions](#)
- [6] [ANNEX B \(informative\) Testing Requirements](#)
- [7] [ANNEX C \(informative\) Suggested Test Setups and Configurations](#)
- [8] [ANNEX D Stressing the device under test \(DUT\)](#)

Resource Requirements: A testing station that is capable of transmitting so that a packet is received by the DUT during interPacket Spacing and capable of monitoring traffic from the DUT.

Last Modification: November 9, 2015

Discussion: In half duplex mode, carrier sense is a physical signal provided by the physical layer to the MAC when any device on the network is transmitting. InterPacketGap, which is equal to 96 bit times, begins when a device is not transmitting and carrier sense is false. The InterPacketGap is divided into two parts: IPGP1, which is defined as 2/3 or less of InterPacketGap, and InterPacketGapPart2 (IPGP2), which is equal to [InterPacketGap – IPGP1]. If carrier sense is asserted during IPGP1 then the DUT must defer the transmission of any packets in waiting until after carrier sense is de-asserted. If carrier sense is asserted during IPGP2 then the DUT must transmit any packet that is in waiting when IPG is completed.

The value for InterPacketGapPart1 is not defined but is determined by the vendor. An initial period shorter than 2/3 of InterPacketGap (or 64 bit times) is permissible down to and including zero.

Test Setup: Connect the device under test (DUT) to the testing station with the appropriate medium (i.e. unshielded twisted pair (UTP), shielded twisted pair (STP), balanced copper, multi-mode fiber, etc.) and transmit a valid packet to the DUT to ensure that the DUT is functioning properly. See [Annex C](#) for suggested test configurations.

Procedure:

Part A:

1. The testing station is instructed to send a valid packet, a minimum IPG, a long carrier event and finally another carrier event that is separated by a gap consisting of idle. The length of the gap is 'n' (see Table 4 - 16).
2. Determine the smallest gap where a collision consistently occurs (see Figure 4 – 16 and Figure 4 – 17).
3. Determine the largest gap where consistently no collision occurs (see Figure 4 – 16 and Figure 4 – 17).

Table 4 - 16 Values for InterPacketGapPart1 Timing Test

	Initial value of 'n'	Value of 'x'
10Mb/s	'n' = 1 bit	'x' = 1 bit
100Mb/s	'n' = 8 bits	'x' = 0.8 bits (1 bit at PHY)
1000BASE-T	'n' = 8 bits	'x' = 8 byte
1000BASE-X	'n' = 32 bits	

Note: For 1000BASE-X devices the smallest IPG is 4 bytes long (because /I/ is a two code-group sequence and because End_of_Packet delimiter (EPD) is a two or three byte sequence). In order to increment the length of the IPG between the two long carrier events, it is necessary to send two different carrier events, one an odd number of octets and one an even number of octets, for each amount of /I/ transmitted.

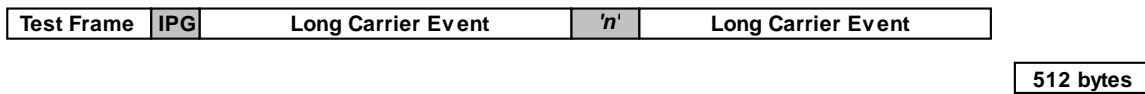

Figure 4 - 66 Carrier Sense Asserted During IPGP1

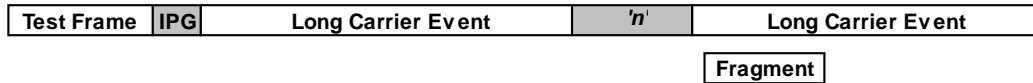

Figure 4 - 77 Carrier Sense Asserted During IPGP2

Observable Results:

- a. If the testing station receives a reply without collision after the long carrier events, it indicates that IPGP1 did not expire. This means that IPGP1 is greater than 'n'. If the testing station captures a collision fragment and then a reply after completing step 2, IPGP1 is less than or equal to the IPG 'n'. The value of IPGP1 must not be larger than 2/3 of interPacketGap (96 bit times).

Possible Problems:

- To ensure fair access to the network all 100BASE-X devices must satisfy the following: (MAX MDI to MAC Carrier De-assert Detect) – (MIN MDI to MAC Carrier Assert Detect) < 13 Bit Times; and all 1000BASE-T and 1000BASE-X must satisfy the following: (MAX MDI to MAC Carrier De-assert Detect) – (MIN MDI to MAC Carrier Assert Detect) < 16 Bit Times. This means that, depending on the PHY used, InterPacketGap could appear to the MAC to be less than it actually is.

GROUP 6: Backoff

Scope: The following tests cover MAC operations specific to collision backoff and retransmission (half duplex mode only) and the truncated binary exponential backoff (TBEBO) algorithm.

Overview: These tests are designed to verify that the device properly implements the TBEBO mechanism. The MAC functions explored are defined in Clause 4 of IEEE 802.3.

*The University of New Hampshire
InterOperability Laboratory*

Test #4.6.1 - Retransmission Attempt Limit

Purpose: To verify that the device under test (DUT) allows a maximum of 15 attempts for retransmission after a collision.

References:

- [1] IEEE Std 802.3-2012, subclause 4.1.2.2 - Access interference and recovery
- [2] IEEE Std 802.3-2012, subclause 4.2.3.2.3 - Collision handling (half duplex mode only)
- [3] IEEE Std 802.3-2012, subclause 4.2.3.2.4 - Collision detection and enforcement (half duplex mode only)
- [4] IEEE Std 802.3-2012, subclause 4.2.3.2.5 - Collision backoff and retransmission (half duplex mode only)
- [5] IEEE Std 802.3-2012, subclause 4.4.2 - MAC parameters
- [6] IEEE Std 802.3-2012, subclause 35.2.2.12 - COL (collision detected)
- [7] IEEE Std 802.3, 2012 Edition - subclause 36.2.5.2.1 - Transmit, Figure 4-2 (a) - TransmitFrame and Figure 35-15 - Transmission with collision
- [8] [ANNEX A \(informative\) Table of Acronym Definitions](#)
- [9] [ANNEX B \(informative\) Testing Requirements](#)
- [10] [ANNEX C \(informative\) Suggested Test Setups and Configurations](#)

Resource Requirements: A testing station capable of transmitting a frame so that it is received while the DUT is transmitting and capable of monitoring traffic from the DUT.

Last Modification: November 9, 2015

Discussion: In half duplex mode, if a device is transmitting a packet and then receives a packet, a collision occurs. After a collision each station is required to transmit 32 bits of jam so that the collision is propagated to all stations on the network and to back off for a random amount of time before attempting to retransmit the packet involved in the collision.

In the event of repeated collisions during the attempted transmission of a packet, the DUT should only attempt a total of only 15 retransmissions, for a total of 16 transmission attempts and then drop the frame.

Test Setup: Connect the device under test (DUT) to the testing station with the appropriate medium (i.e. unshielded twisted pair (UTP), shielded twisted pair (STP), balanced copper, multi-mode fiber, etc.) and transmit a valid packet to the DUT to ensure that the DUT is functioning properly. See [Annex C](#) for suggested test configurations.

Procedure:

Part A:

1. In half duplex mode the DUT is instructed to transmit a properly encapsulated, valid frame.
2. The testing station is then instructed to send a fragment so that a collision occurs within slotTime.
3. Step 2 is repeated until transmission attempts from the DUT cease, or until a consistent pattern of retransmission attempts can be determined.

Observable results:

- a. The testing station should capture 16 collision fragments. Each fragment should consist of complete preamble, any terminated data transmission and a 32-bit jam pattern. The testing station should not capture a complete, valid packet.

Possible Problems:

*The University of New Hampshire
InterOperability Laboratory*

- Some devices will not cease attempting to retransmit frames involved in collisions. This may not indicate that there is a problem with the MAC sublayer, but that a higher layer is initiating the retransmission attempts.

Test #4.6.2 - Truncated Binary Exponential Back Off test

Purpose: To verify that the device under test (DUT), correctly calculates the time to wait before attempting retransmission.

References:

- [1] IEEE Std 802.3-2012, subclause 4.1.2.2 - Access interference and recovery
- [2] IEEE Std 802.3-2012, subclause 4.2.3.2.3 - Collision handling (half duplex mode only)
- [3] IEEE Std 802.3-2012, subclause 4.2.3.2.4 - Collision detection and enforcement (half duplex mode only)
- [4] IEEE Std 802.3-2012, subclause 4.2.3.2.5 - Collision backoff and retransmission (half duplex mode only)
- [5] IEEE Std 802.3-2012, subclause 4.4.2 - MAC parameters
- [6] IEEE Std 802.3-2012, subclause 35.2.2.10 - Receive direction LPI transition
- [7] IEEE Std 802.3, 2008 Edition subclause 36.2.5.2.1 - Transmit, Figure 4-2 (a) - TransmitFrame and Figure 35-15 - Transmission with collision
- [8] [ANNEX A \(informative\) Table of Acronym Definitions](#)
- [9] [ANNEX B \(informative\) Testing Requirements](#)
- [10] [ANNEX C \(informative\) Suggested Test Setups and Configurations](#)

Resource Requirements: A testing station capable of transmitting a frame so that it is received while the DUT is transmitting and capable of monitoring the time delay before any retransmission attempts from the DUT.

Last Modification: Novmeber 9, 2015

Discussion: In half duplex mode, if a device is transmitting a packet and then receives a packet, a collision occurs. After a collision, each station is required to transmit 32 bits of jam so that the collision is propagated to all stations on the network and to back off for a random amount of time before attempting to retransmit the packet involved in the collision.

The scheduling of the retransmissions is determined by a controlled randomization process called **Truncated Binary Exponential BackOff**. At the end of enforcing a collision (jamming), the CSMA/CD sublayer delays before attempting to retransmit the frame. The delay is an integer multiple of slotTime. The number of slotTimes to delay before the nth retransmission attempt is chosen as a uniformly distributed random integer r in the range:

$$0 \leq r < 2^k \text{ where } k = \min(n, 10)$$

The value for 'k' should always be the lesser of the value of 'n' and the number 10. The value of 'k' is then used to determine the range for 'r'. Because 'r' is chosen as a uniformly distributed random integer in this range, we can use the value of 'r' to determine compliance of the DUT. Repeated samples are acquired for each value of 'k' to determine the distribution of 'r'.

Test Setup: Connect the device under test (DUT) to the testing station with the appropriate medium (i.e. unshielded twisted pair (UTP), shielded twisted pair (STP), balanced copper, multi-mode fiber, etc.) and transmit a valid packet to the DUT to ensure that the DUT is functioning properly. See [Annex C](#) for suggested test configurations.

Procedure:

Part A:

1. In half duplex mode, the DUT is instructed to transmit a valid packet.

The University of New Hampshire
InterOperability Laboratory

2. The testing station is then instructed to send a fragment so that a collision occurs at the DUT within slotTime.
3. Step 2 is repeated 15 times and the time difference between retransmission attempts is recorded.
4. This test should be repeated until the testing station has acquired a sufficient number of samples to determine whether or not the average backoff for each of the fifteen different retransmission attempts is more aggressive than the expected average for that attempt, which is $\frac{1}{2}(2^k-1)$.

Part B:

1. In half duplex mode, the DUT is instructed to transmit a valid packet.
2. The testing station is then instructed to send a fragment so that a collision occurs at the DUT within slotTime.
3. Step 2 is repeated 15 times and the time difference between retransmission attempts is recorded.
4. This test should be repeated until the testing station has acquired a sufficient number of samples to determine the underlying distribution of the random variable 'r'.

Observable results:

- a. It is acceptable for the combined average backoff for any of the fifteen retransmission attempts to be less aggressive but it is unacceptable for any to be more aggressive.
- b. Each time the procedure is executed, the time difference between transmissions should be 0 to (2^k-1) . Given enough samples, the distribution of the values for 'r' should be uniformly distributed random integer values.

Possible Problems:

- If a device has a very slow response time it may be difficult to collect enough measurements to accurately test the DUT's back off algorithm.

GROUP 7: Frame Bursting

Scope: The following tests cover MAC operations specific to Gigabit devices running in half duplex mode and bursting.

Overview: These tests are designed to verify that the device under test (DUT) correctly implements Burst Mode as defined in the IEEE standard. This includes verifying that the DUT transmits extension in interframe Spacing interval when in burst mode and that it enforces the burst timer of 64Kb (65536). The MAC functions explored are defined in Clause 4 of IEEE 802.3.

*The University of New Hampshire
InterOperability Laboratory*

Test #4.7.1 - Interpacket Fill

Purpose: To verify that the device under test (DUT), when in half duplex mode at 1000Mb/s, transmits extension in the interpacket spacing interval when in burst mode.

References:

- [1] IEEE Std 802.3-2012, subclause 4.2.3.2.7 - Packet bursting
- [2] IEEE Std 802.3-2012, subclause 4.2.3.4 - Carrier extension
- [3] IEEE Std 802.3-2012, subclause 4.2.8 - Frame transmission
- [4] IEEE Std 802.3-2012, subclause 4.2.9 - Frame reception
- [5] IEEE Std 802.3-2012, subclause 4.4.2 - MAC parameters
- [6] [ANNEX A \(informative\) Table of Acronym Definitions](#)
- [7] [ANNEX B \(informative\) Testing Requirements](#)
- [8] [ANNEX C \(informative\) Suggested Test Setups and Configurations](#)

Resource Requirements: A testing station capable of capturing complete packets including carrier extension bits transmitted by the DUT. GMII or PCS access and or control by the testing station are ideal.

Last Modification: November 9, 2015

Discussion: At speeds equal to 1000Mb/s, once a packet has been successfully transmitted (with extension if necessary), the transmitting station can begin transmission of another packet without contending for the medium because all of the other stations on the network will continue to defer to its transmission, provided that it does not allow the medium to assume an idle condition between packets. The transmitting station fills the interpacket spacing interval with extension bits, which are readily distinguished from data bits at the receiving stations, and ensure the detection of carrier by the receiving stations. The length of this interpacket spacing interval is defined as 96 bit times. The MAC should continue to monitor the medium for collisions while it is transmitting extension bits, and treat any collision that occurs after the threshold (slotTime - headerSize) as a late collision.

Test Setup: Connect the device under test (DUT) to the testing station with the appropriate medium (i.e. unshielded twisted pair (UTP), shielded twisted pair (STP), balanced copper, multi-mode fiber, etc.) and transmit a valid packet to the DUT to ensure that the DUT is functioning properly. See [Annex C](#) for suggested test configurations.

Procedure:

Part A:

1. The DUT is instructed to transmit a burst of packets.

Observable Results:

- a. The testing station should capture the burst transmitted by the DUT. The initial frame in the burst should be either greater than or equal to 512 bytes in length or extended to 512 bytes in length, and each packet within the burst should be separated by 96 carrier extension bits (not including any carrier extension bits transmitted as part of the initial packet).

Possible Problems:

- The DUT may not support Bursting.
- It may be difficult to force the DUT to transmit bursts of frames due to internal latencies.

*The University of New Hampshire
InterOperability Laboratory*

Test #4.7.2 - Burst limit

Purpose: To verify that the device under test (DUT) when in half duplex mode at 1000Mb/s enforces the burstLimit of 64Kb (65536 bits).

References:

- [1] IEEE Std 802.3-2012, subclause 4.2.3.2.7 - Packet bursting (half duplex mode only)
- [2] IEEE Std 802.3-2012, subclause 4.2.3.4 - Carrier extension (half duplex mode only)
- [3] IEEE Std 802.3-2012, subclause 4.2.8 - Frame transmission
- [4] IEEE Std 802.3-2012, subclause 4.2.9 - Frame reception
- [5] IEEE Std 802.3-2012, subclause 4.4.2 - MAC parameters, Figure 4-3b - BurstTimer Process
- [6] ANNEX A (informative) Table of Acronym Definitions
- [7] ANNEX B (informative) Testing Requirements
- [8] ANNEX C (informative) Suggested Test Setups and Configurations

Resource Requirements: A testing station capable of transmitting packets with carrier extension and capable of capturing complete packets including carrier extension bits. GMII or PCS access and or control by the testing station are ideal.

Last Modification: November 9, 2015

Discussion: For devices operating in half duplex mode at 1000Mb/s, once a packet has been successfully transmitted (with extension if necessary), the transmitting station may begin transmission of another packet without contending for the medium. All other stations on the network must continue to defer to the transmitting station, provided that it does not allow the medium to assume an idle condition between packets. The transmitting station fills the interpacket spacing interval with extension bits, which are readily distinguished from data bits by the receiving stations, and which cause the receiving stations' PHYs to continue asserting carrier sense. The MAC continues to monitor the medium for collisions while it is transmitting extension bits, and it will treat any collision, which occurs after the threshold (slotTime - headerSize) as a late collision.

The burstLimit is defined as 64Kb (65536 bits). Once the burstLimit has been reached, the transmitting station exits burst mode. After the current packet is successfully transmitted, the interpacket spacing interval is filled with idle instead of extension bits, thus relinquishing control of the medium. This establishes the maximum carrier event as the burst limit minus one (65535 bits) plus the header size (64 bits), plus maximum frame size (12800 bits) (a 2000 byte envelope frame).

Test Setup: Connect the device under test (DUT) to the testing station with the appropriate medium (i.e. unshielded twisted pair (UTP), shielded twisted pair (STP), balanced copper, multi-mode fiber, etc.) and transmit a valid packet to the DUT to ensure that the DUT is functioning properly. See [Annex C](#) for suggested test configurations.

Procedure:

Part A:

1. The testing station is instructed to transmit five 1518 byte frames, then a 480 + 'n' byte frame and the maximum supported MAC frame size for the device. The initial value of 'n' is 0. The DUT should reply to all of the frames in burst mode.
2. The value 'n' is incremented by 1 and the test burst is retransmitted.
3. Repeat steps 1 and 2 until the last frame is observed to be transmitted outside of the Burst.

Five 1518 byte frames with 8 bytes of Preamble and ext in	P & SFD	480 + n byte frame	Ext	P & SFD	MAX byte frame
---	---------	--------------------	-----	---------	----------------

Figure 4 - 88 Burst limit – Test Case

*The University of New Hampshire
InterOperability Laboratory*

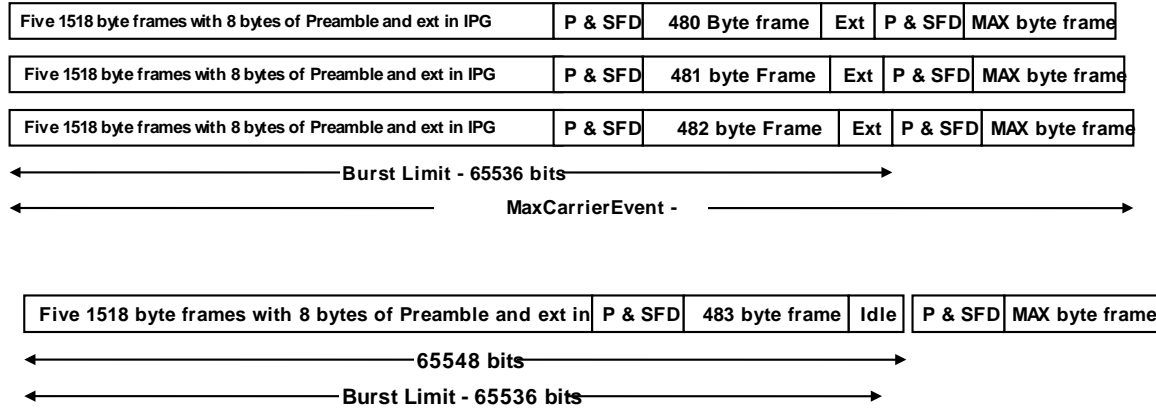

Figure 4 - 99 Burst limit – Example Test Cases

Observable Results:

- a. The testing station should capture a Burst containing 5 valid 1518 byte frames, each separated by interPacket Spacing Interval consisting of extension bits, the 480 + 'n' byte frame and the final 1518 byte frame. If the value of 'n' is less than 3 then the last two frames should be transmitted as part of the burst. When the value of 'n' is 3 then the final frame should not be transmitted as part of the burst because burstLimit will have expired before the beginning of the final frame. This can be verified by observing the transmission of idle during IPG.

Possible Problems:

- The DUT may not support Bursting.
- It may be difficult to force the DUT to transmit bursts of frames due to internal latencies.
- Frames other than 1518 byte frames may have to be used in order to cause some devices to transmit in burst mode.

The University of New Hampshire
InterOperability Laboratory

Test #4.7.3 - Receive Frame Bursts

Purpose: To verify that the device under test (DUT) can receive bursts of frames.

References:

- [1] IEEE Std 802.3-2012, subclause 4.2.3.2.7 - Packet bursting (half duplex mode only)
- [2] IEEE Std 802.3-2012, subclause 4.2.3.4 - Carrier extension (half duplex mode only)
- [3] IEEE Std 802.3-2012, subclause 4.2.8 - Frame transmission
- [4] IEEE Std 802.3-2012, subclause 4.2.9 - Frame reception
- [5] IEEE Std 802.3-2012, subclause 4.4.2 - MAC parameters, Procedure *PhysicalSignalDecap*, Process *BitReceiver*
- [6] [ANNEX A \(informative\) Table of Acronym Definitions](#)
- [7] [ANNEX B \(informative\) Testing Requirements](#)
- [8] [ANNEX C \(informative\) Suggested Test Setups and Configurations](#)

Resource Requirements: A testing station that is capable of transmitting packets with carrier extension and capable of monitoring traffic from the DUT.

Last Modification: November 9, 2015

Discussion: In half-duplex mode at 1000 Mb/s, an implementation may optionally transmit a series of frames without relinquishing control of the transmission medium. This mode of operation is referred to as burst mode. The first frame of a burst must always be at least slotTime in length (4096 bits), which may be accomplished through the addition of extension bits. Once this first packet has been successfully transmitted, the transmitting station can begin transmission of another packet without contending for the medium. Other stations on the network will continue to defer to its transmission, provided that the transmitting station does not allow the medium to assume an idle condition between packets. To do this the transmitting station fills the interpacket spacing interval with extension bits in order to maintain control of the medium. The transmitting station is allowed to initiate packet transmission until a specified limit, referred to as burstLimit, is reached. The value of burstLimit is specified in clause 4.4.2.

If the first frame within a burst is not slotTime in length (4096 bits) than the BitReceiver process should not set the variable *extending* to false and should discard all frames in the burst until the burst reaches slotTime in length. Once the burst reaches slotTime in length the DUT should finish receiving the current frame **and discard it**; all other frames received after the burst reaches slotTime that are at least minFrameSize in length should be accepted.

In full duplex mode and at 1000Mb/s, bursting is not necessary because a device does not have to contend for the medium and, therefore, a device need not attempt to maintain control of the medium by transmitting bursts of frames. If a burst is received while in full duplex mode, the variable *extending* should always be false. This guarantees that the inner loop of the *BitReceiver* process is exited and that each frame within the burst properly accepted. The *PhysicalSignalDecap* Procedure should then discard the extension between each packet before the packets are de-capsulated. Each valid frame within the burst should, therefore, be accepted, and the burst should not interfere with the reception of other valid frames.

Test Setup: Connect the device under test (DUT) to the testing station with the appropriate medium (i.e. unshielded twisted pair (UTP), shielded twisted pair (STP), balanced copper, multi-mode fiber, etc.) and transmit a valid packet to the DUT to ensure that the DUT is functioning properly. See [Annex C](#) for suggested test configurations.

Procedure:

*The University of New Hampshire
InterOperability Laboratory*

Part A:

1. The testing station is instructed to transmit burst 1 (as described in Table 4 - 17). The output of the DUT is observed.
2. The testing station is instructed to repeat step 1 with each test sequence. Other test sequence may be included to help determine the how the DUT is handling packet bursts.

Table 4 - 17 Receive Packet Bursts

	Test Sequences
1	A 512 byte frame, 12 bytes of extension, and a 64 byte frame
2	A 64 byte frame with 448 bytes of extension, 12 bytes of extension, and a 64 byte frame
3	A 64 byte frame, 12 bytes of extension, and a 64 byte frame
4	A burst consisting of 5 1518 byte frames, a 482 byte frame and another 1518 byte frame

Part B:

1. The testing station is instructed to repeat *Part A* with each test sequence preceded and followed by a valid frame.

Observable Results:

- a. The DUT should respond to each burst according to the following table.

	Full Duplex	Half Duplex
1	The DUT should accept every frame.	The DUT should accept every frame.
2	The DUT should accept every frame.	The DUT should accept every frame.
3	The DUT should accept every frame.	Both frames should be discarded.
4	The DUT should accept every frame.	The DUT should accept every frame.

Table 4 - 18 Interpretation of Burst Reception Results

- b. The reception of the test frame should not interfere with the reception of valid frames.

Possible Problems: None

*The University of New Hampshire
InterOperability Laboratory*

Test #4.7.4 - Reception of Bursts with an Initial Frame Less than slotTime

Purpose: To verify that the device under test (DUT) detects and properly responds to the reception of fragments during a burst.

References:

- [1] [IEEE Std 802.3-2012, subclause 4.2.3.2.7 - Packet bursting \(half duplex mode only\)](#)
- [2] [IEEE Std 802.3-2012, subclause 4.2.3.4 - Carrier extension \(half duplex mode only\)](#)
- [3] [IEEE Std 802.3-2012, subclause 4.2.9 - Frame reception](#)
- [4] [IEEE Std 802.3-2012, subclause 4.4.2 - MAC parameters; Procedure PhysicalSignalDecap, Processes BitReceiver and SetExtending](#)
- [5] [ANNEX A \(informative\) Table of Acronym Definitions](#)
- [6] [ANNEX B \(informative\) Testing Requirements](#)
- [7] [ANNEX C \(informative\) Suggested Test Setups and Configurations](#)

Resource Requirements: A testing station that is capable of transmitting packets with carrier extension and capable of monitoring traffic from the DUT.

Last Modification: November 9, 2015

Discussion: In half-duplex mode at 1000 Mb/s, an implementation may optionally transmit a series of frames without relinquishing control of the transmission medium for a set period of time. This mode of operation is referred to as burst mode. The first frame of a burst must be at least slotTime in length (4096 bits), which may be accomplished with the addition of extension bits. If the first frame within a burst is not slotTime in length (4096 bits), the BitReceiver process will not set the *extending* variable to false and will discard all frames in the burst until the burst reaches slotTime in length. Once slotTime is reached the current frame and all previous frames should be discarded by the DUT, and all other frames that are at least minFrameSize in length should be accepted.

When the first frame in a burst is less than slotTime in length the *BitReceiver* process remains in the inner loop for two reasons:

- 1) In half duplex mode the variable *receiveDataValid* is set to true during the reception of the entire burst (including extension bits),
- 2) The variable *frameFinished* is not set to true until the bit after *extending* is set to false, which only occurs when the burst length reaches slotTime in length.

In addition, each frame received or being received before slotTime is reached will be concatenated onto the previous frames until slotTime is reached and *extending* is set to false.

Extension bits must separate each packet within a burst. If the initial frame in a burst is less than slotTime in length these extension bits will be seen by the receive MAC as extending the length of the initial packet and not as a delineator between each packets. If the initial frame in the burst is (slotTime – 8 bits) to (slotTime – 88) the second frame in the burst may be discarded not because the initial frame is too short but because the interPacketGap between each packet is too short.

Test Setup: Connect the device under test (DUT) to the testing station with the appropriate medium (i.e. unshielded twisted pair (UTP), shielded twisted pair (STP), balanced copper, multi-mode fiber, etc.) and transmit a valid packet to the DUT to ensure that the DUT is functioning properly. See [Annex C](#) for suggested test configurations.

Procedure:

Part A:

*The University of New Hampshire
InterOperability Laboratory*

1. The testing station is instructed to transmit burst 1 (as described in Table 4 - 19). The output of the DUT is observed.
2. The testing station is instructed to repeat step 1 with each test sequence. Other test sequences may be included to determine how the DUT is handling bursts which have an initial frame less than slotTime in length.

Table 4 - 19 Reception of Bursts with an initial frame less than slotTime

	Test Sequences
1	500 byte frame, 12 bytes of extension, 64 byte frame
2	501 byte frame, 12 bytes of extension, 64 byte frame
3	511 byte frame, 12 bytes of extension, 64 byte frame
4	64 byte frame, 448 bytes of extension, 64 byte frame
5	64 byte frame, 449 bytes of extension, 64 byte frame
6	64 byte frame, 459 bytes of extension, 64 byte frame
7	64 byte frame, 12 bytes of extension, 435 byte frame, 12 bytes of extension, 64 byte frame
8	64 byte frame, 12 bytes of extension, 436 byte frame, 12 bytes of extension, 64 byte frame
9	46 byte frame, 12 bytes of extension, 512 byte frame, 12 bytes of extension, 64 byte frame
10	8 64-byte frames each separated by 12 bytes of extension.

Observable Results:

- a. The DUT should accept each frame within the burst that is received in its entirety after the completion of slotTime. If the initial frame in a burst is extended to less than slotTime but the addition of interPacketGap (extension bits) extends the carrier event to slotTime the initial frame should be received but the second frame may be discarded as it will see less than the minimum interPacketGap between the first and the second frame.

	Excepted Results
1	Both frames should be discarded
2	The 501 byte frame should be received and the 64 byte frame may be discarded
3	The 511 byte frame should be received and the 64 byte frame may be received
4	Both frames should be discarded
5	The first 64 byte frame should be received and the second 64 byte frame may be discarded
6	The first 64 byte frame should be received and the second 64 byte frame may be received
7	The first two frames should be discarded while the last 64 byte frame may be received
8	The first two frames should be discarded while the last 64 byte frame should be received
9	The first two frames should be discarded while the last 64 byte frame should be received
10	The last 64 byte frame should be received while all other should be discarded

Table 4 - 20 Interpretation of Burst Error Reception Results

Possible Problems:

- The extension between the first and second packet in test sequences one through six, the second and third packet in test sequences seven and eight may be considered part of the previous packet (extension) and not interPacketGap. Thus the second or third packet may be discarded or accepted depending on the DUT's ability to accept packets separated by less than minimum interPacketGap.

ANNEX A (informative) Table of Acronym Definitions

Table of Acronym Definitions

Table 4 - 21 Acronym Definitions

8802-3	ISO/IEC 8802-3 (IEEE Std 802.3)
ANSI	American National Standards Institute
ASIC	application-specific integrated circuit
ASN.1	abstract syntax notation one as defined in ISO/IEC 8824: 1990
AUI	attachment unit interface
BER	bit error ratio
BPSK	binary phase shift keying
BR	bit rate
BT	bit time
CAT3	Category 3 balanced cable
CAT4	Category 4 balanced cable
CAT5	Category 5 balanced cable
CDO	clocked data zero
CD1	clocked data one
CGMII	100 Gigabit Media Independent Interface
CMIP	common management information protocol as defined in ISO/IEC 9596-1: 1991
CMIS	common management information service as defined in ISO/IEC 9595: 1991
CMOS	complimentary metal oxide semiconductor
CRC	cyclic redundancy check
CRV	code rule violation
CS0	control signal zero
CS1	control signal one
CVH	clocked violation high
CVL	clocked violation low
CW	continuous wave
DA	Destination Address
DTE	data terminal equipment
DUT	Device Under Test
EIA	Electronic Industries Association.
ELFEXT	equal-level far-end crosstalk
EMB	effective modal bandwidth
EMI	Electromagnetic Interference
EPD	End_of_Packet delimiter
ESD	End-of-Stream delimiter
FCS	Frame Check Sequence
FC-PH	Fibre Channel - Physical and Signaling Interface
FOTP	fiber optic test procedure
GMII	Gigabit Media Independent Interface
IEC	International Electrotechnical Commission

*The University of New Hampshire
InterOperability Laboratory*

IPG	interPacketGap
IPGP1	interPacketGapPart1
IPGP2	interPacketGapPart2
IH	intermediate hub
IRL	inter-repeater link
ISI penalty	intersymbol interference penalty
ISO	International Organization for Standardization
LAN	local area network
LLC	logical link control
LSDV	link segment delay value
MAC	medium access control
MAU	medium attachment unit
MC	message code
MDELNEXT	multiple-disturber equal-level far-end crosstalk
MDFEXT	multiple-disturber far-end crosstalk
MDI	medium dependent interface
MDNEXT	multiple-disturber near-end crosstalk
MIB	management information base
MII	media independent interface
MMF	multimode fiber
MP	message page
NEXT	near-end crosstalk
NLP	normal link pulse
NPA	next page algorithm
NRZI	non return to zero and invert on ones
OFL	overfilled launch
OFSTP	optical fiber system test procedure
PCS	physical coding sublayer
PDV	path delay value
PHY	Physical Layer entity sublayer
PICS	protocol implementation conformance statement
PLS	physical signaling sublayer
PMA	physical medium attachment
PMD	physical medium dependent
PMI	physical medium independent
PPD	peak-to-peak differential
PVV	path variability value
RD	running disparity
RFI	Radio Frequency Interference
RIN	relative intensity noise
ROFL	radial overfilled launch
RS	reconciliation sublayer
SA	Source Address
SDV	segment delay value
SFD	start-of-frame delimiter
SMF	singlemode fiber
SPD	Start_of_Packet delimiter

*The University of New Hampshire
InterOperability Laboratory*

SR	symbol rate
SSD	Start-of-Stream delimiter
ST	symbol time
STE	station management entity
STP	shielded twisted pair (copper)
SVV	segment variability value
TDR	Time Domain Reflectometer
TIA	Telecommunications Industry Association
UCT	unconditional transition
UP	unformatted page
UTP	unshielded twisted pair
XLGMII	40 Gigabit Media Independent Interface
WCMB	worst case modal bandwidth

ANNEX B (informative) Testing Requirements

Testing requirements.

A testing station that implements transmit (encoding) and receive (decoding) functions specific to the Ethernet PHY in use by the device under test (DUT). MDI, AUI, MII, GMII or PCS access and or control by the testing station are ideal.

Typical Testing Stations:

Arbitrary Waveform Generator
Logic Analyzer with Pattern Generator
Symbol Generating Device
Sniffer, traffic generator (i.e. SmartBits...)

ANNEX C (informative) Suggested Test Setups and Configurations

Suggested Test Setups and Configurations for Single Port Devices and End Station Devices

The following test setups are specific to certain physical layers.

The setup described in Figure 4 – 20 can be used to test 10Base-T devices. Observations can be used to monitor the TD and RD circuits with differential probes placed at the same point on the cable.

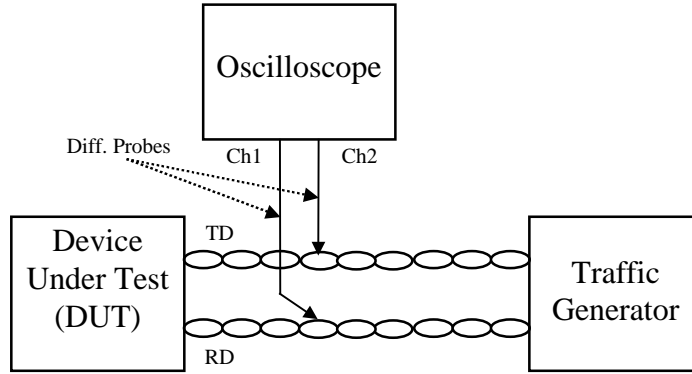

Figure 4 - 20 Test Setup for 10BASE-T Device

The setup described in Figure 4 - 21 and Figure 4 - 22 can be used to test 100BASE-X devices.

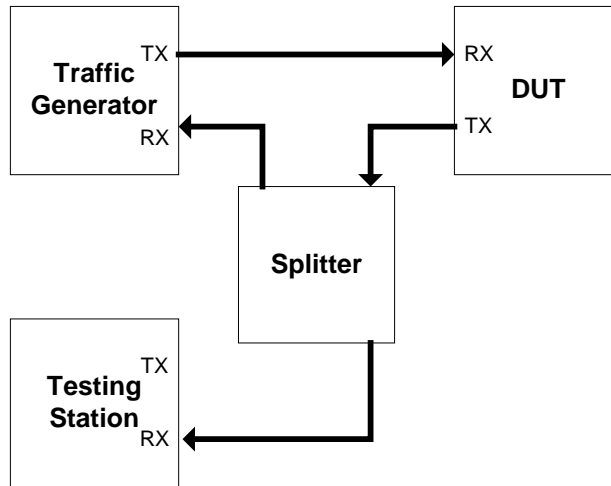

Figure 4 - 21 Test Setup#1 for 100BASE-X Devices

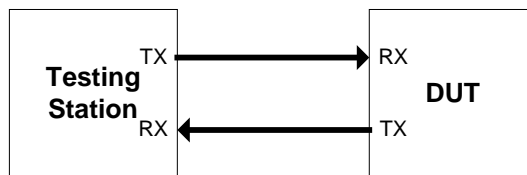

Figure 4 - 22 Test Setup#2 for 100BASE-X Devices

The setup described in Figure 4 - 23 and Figure 4 - 24 can be used to test 1000BASE-X devices. The DUT may be connected directly to the testing station, or the testing station may be set up to monitor the packets transmitted by the DUT a traffic generator.

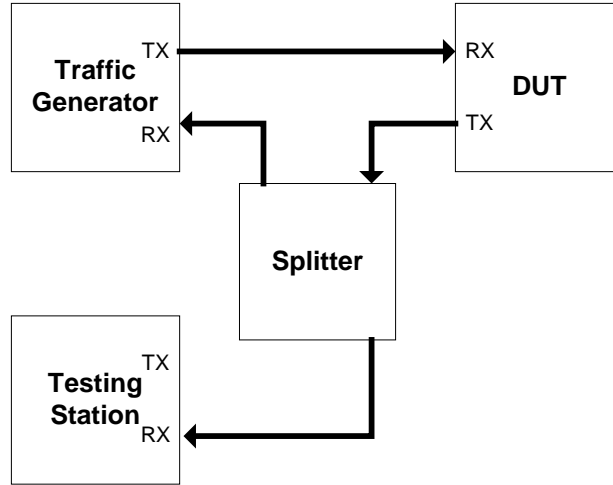

Figure 4 - 103 Test Setup#1 for 1000BASE-X Devices

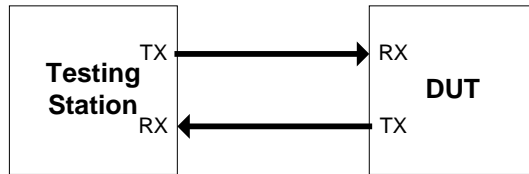

Figure 4 - 24 Test Setup#2 for 1000BASE-X Devices

The setup described in Figure 4 - 25 can be used to test 1000BASE-T devices.

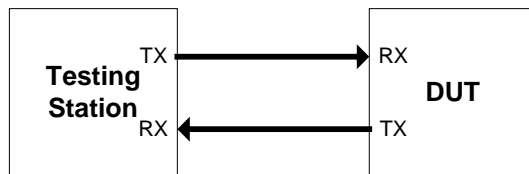

Figure 4 - 115 Test Setup for 1000BASE-T Devices

Suggested Test Setup for Switches

For switches connect the Testing Station to the Port Under Test of the DUT, and place a second traffic generator/ traffic monitor on another port of the DUT.

ANNEX D Stressing the device under test (DUT)

Under most conditions a device will function properly. A device is more likely to malfunction while operating under stressful conditions; this may be accomplished using a variety of different methods, some of these methods are listed below:

Reception of a large number of frames

Send the DUT a long series of frames that require a reply from the DUT. To stress the device further the preamble and the spacing between packets can be reduced. In this way the DUT will be receiving frames at a rate greater than it can legally reply to them.

Using PAUSE frames

Send the DUT one or more pause frames while it is attempting to reply to or forward multiple frames. The device's buffers should fill and, after `pause_time` has expired, the device should reply to or forward frames at or near line rate.

Forwarding large numbers of frames through a switch

Connect the DUT to two traffic generators and the testing station (as illustrated below). Each port on the DUT should have a full duplex link and each should be configured to link at the same speed (10Mb/s, 100Mb/s or 1000Mb/s). Transmit frames at line rate from the traffic generators so that the DUT attempts to forward them to the testing station (put the individual MAC address of the testing station in the destination address field of the frames being transmitted by the traffic generators).

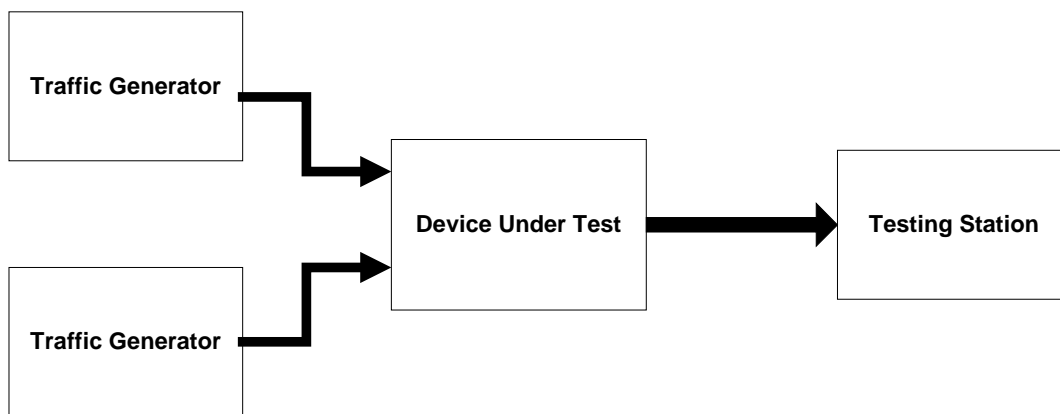

Figure 4 - 126 Stressing a Switch

Using Backpressure

Connect the DUT to the testing station so that a half duplex link of the appropriate speed is established. The DUT is instructed to transmit a large number of frames. The testing station is instructed to cause a collision during each frame so that the DUT is unable to successfully transmit any frames, thus causing the DUT's buffers to fill. The testing station is then instructed to cease causing collisions and the DUT should transmit each frame at or near line rate.