

NZXT

CANVAS 25F

25" FHD (1920X1080) 240HZ GAMING MONITOR

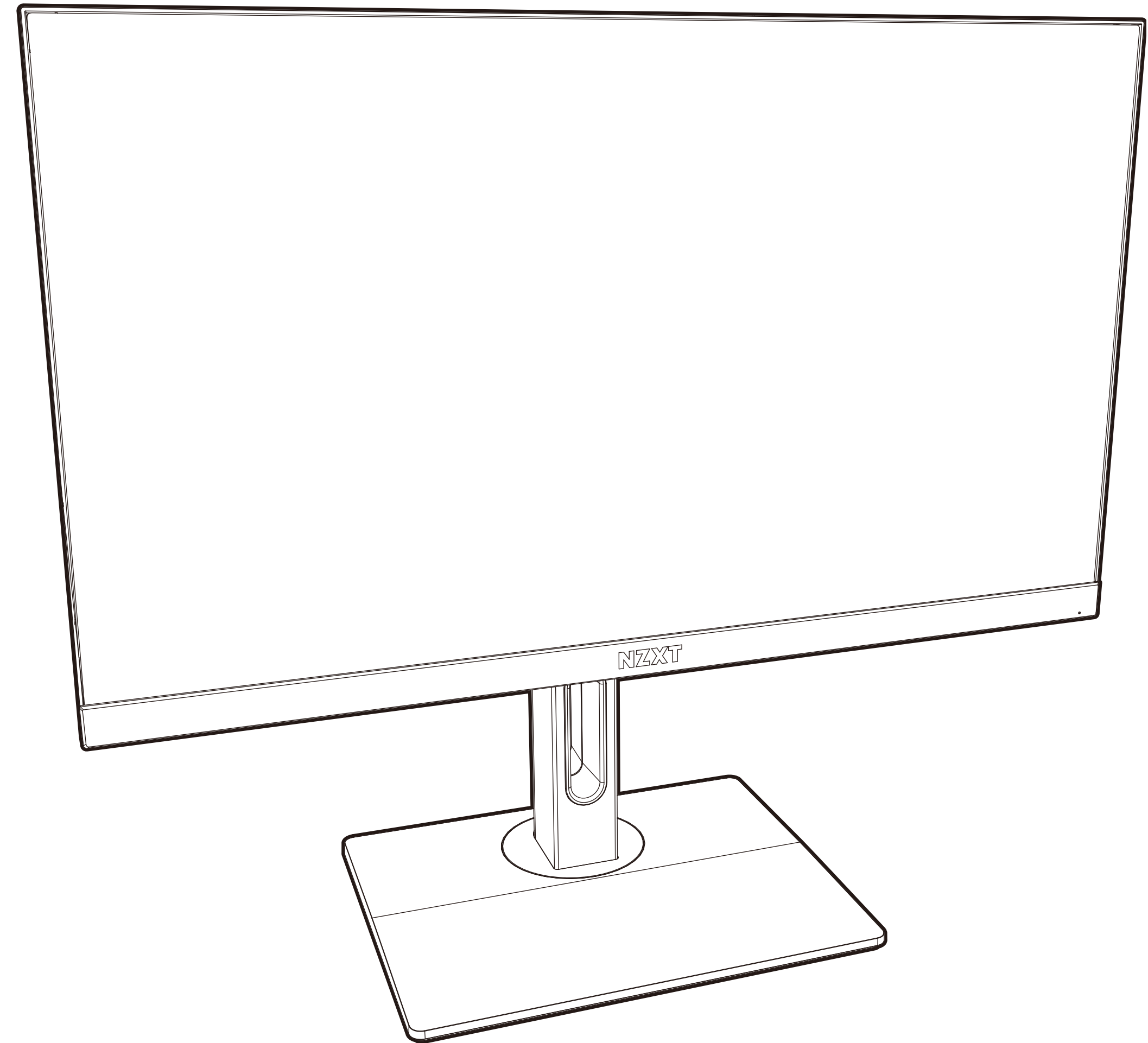

TABLE OF CONTENTS

VERSION 1.2

1. PREFACE 02

2. GETTING STARTED 05

3. INSTALLATION 12

4. MONITOR OSD
(ON-SCREEN DISPLAY) 25

5. CAM SOFTWARE SETUP 30

6. APPENDIX A-1



A. Copyright® NZXT, Inc. All Rights Reserved.

This manual including all illustrations and screen captures, is protected under international copyright laws, with all rights reserved. Neither this manual, nor any of the material contained herein, may be reproduced without written consent of the author.

B. Disclaimer

The information in this document is subject to change without notice. The manufacturer makes no representations or warranties with respect to the contents hereof and specifically disclaims any implied warranties of merchantability or fitness for any particular purpose. The manufacturer reserves the right to revise this publication and to make changes from time to time in the content hereof without obligation of the manufacturer to notify any person of such revision or changes.

C. Trademark Recognition

Product names used in this manual are the properties of their respective owners and are acknowledged.

D. Safety Precautions

Follow these safety precautions when setting up the monitor:

- Keep this User Manual with the package for future reference.
- Read the safety instructions carefully and thoroughly before using this product
- Setup the device on a reliable flat surface.
- To prevent fire or shock hazard, keep this device away from humidity and high temperature. Do not leave the device in an unconditioned environment with a storage temperature above 60°C or below -20°C, may cause damage to the device. Maximum operating temperature of the device is around 40°C.
- Make sure that the power voltage is within its safety range and has been adjusted properly to the value of 100~240V before connecting the device to the power outlet. Do not disable the protective earth pin from the plug. The device must be connected to an earthed mains socket-outlet. Do not place anything on the power cord and avoid the power cord from being stepped on.



- Always disconnect the power cord or switch the wall socket off if the device would be left unused for a certain time to achieve zero energy consumption.
- The ventilator on the device is used for air convection and to prevent the device from overheating. Do not cover the ventilator.
- When cleaning the device, be sure to remove the power plug. Use a piece of soft cloth rather than industrial chemicals to clean the device. Never pour any liquid into the opening; that could damage the device or cause electric shock.
- Always keep strong magnetic or electrical objects away from the device.
- It is recommended to take a 10 minute break for every 30 minutes of screen time.
- It is not recommended for children under 2 years of age to have any screen time. For children 2 years and over, screen time should be limited to less than one hour per day.
- Refer servicing to qualified personnel only. If any of the following situations arises, get the device checked by service personnel:
 - The power cord or plug is damaged.
 - Liquid has penetrated into the device.
 - The device has been exposed to moisture.
 - The device does not work well or you can not get it to work according to the user's manual.

- The device has dropped and damaged.
- The device has obvious signs of breakage.

E. Safety Instructions

Read through the following Safety Precautions before using the monitor:

- Make sure that the power voltage is within its safety range and has been adjusted properly to the value of 100~240V before connecting the device to the power outlet. Do not disable the protective earth pin from the plug. The device must be connected to an earthed mains socket-outlet.
- Only use the accessories that are provided with the monitor or recommended by the manufacturer.
- Always keep strong magnetic or electrical objects away from the device.
- Keep the plastic packaging bag for the product in a place that cannot be reached by children.
- Do not touch the plug with wet hands, it may cause electric shock.
- Place the monitor in a stable and well-ventilated place.
- Do not place the monitor near any heat sources such as electric radiators or direct sunlight.



- The holes or openings on the monitor are for ventilation. Do not cover or block the ventilation holes with any objects.
- Do not use the monitor near water, drinks, or all types of liquids. Failure to do so may result in electric shock or damage to the monitor.
- Make sure to unplug the monitor from the power outlet before cleaning or removal.
- The screen surface is easy to be scratched, avoid touching the surface with any hard or sharp object.
- Use a soft lint-free cloth instead of a tissue to clean the screen. You may use a glass cleaner to clean the monitor if required. However, never spray the cleaner directly onto the screen.
- Always disconnect the power cord or switch the wall socket off if the device would be left unused for a certain time to achieve zero energy consumption.
- Do not attempt to disassemble or repair the monitor yourself.

F. Stability Hazard Instructions

The product may fall, causing serious personal injury or death. To prevent injury, this product must be securely attached to the floor/wall in accordance with the installation instructions.

- Please use stands or installation methods recommended by the manufacturer of the product set.
- Lay this device on a reliable flat surface before setting it up.
- To prevent the monitor from tipping over, secure the monitor to a desk, wall or fixed object with an anti-tip fastener that helps to properly support the monitor and keep it safe in place.
- Please route cords and cables connected to your product so they cannot be tripped over, pulled or grabbed.



2.1 Getting Started.....06

2.2 Monitor Overview.....09

2.2 Package Contents.....07

2.3 Monitor Rear I/O Ports.....11



Caution - It is recommended to wear a grounding strap attached to a grounded device to avoid damage from static electricity.

 **NOTE**

Do not use any sharp objects on the monitor.

2.2 PACKAGE CONTENTS-MONITOR PANEL

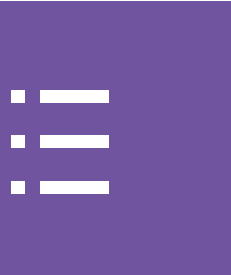

A. Monitor Panel

x1

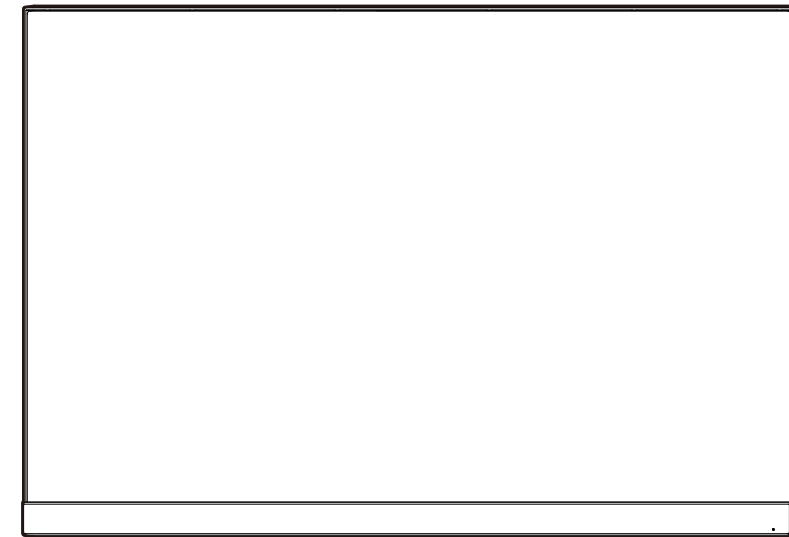

B. Power Cable

x1

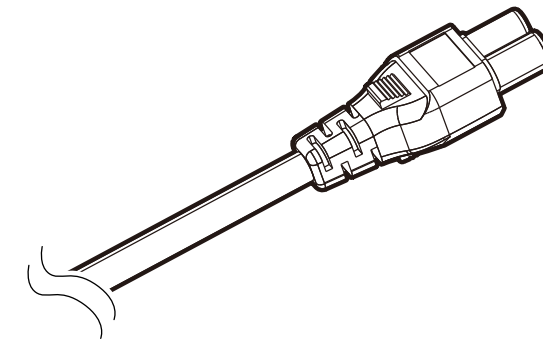

C. Power Adapter

x1

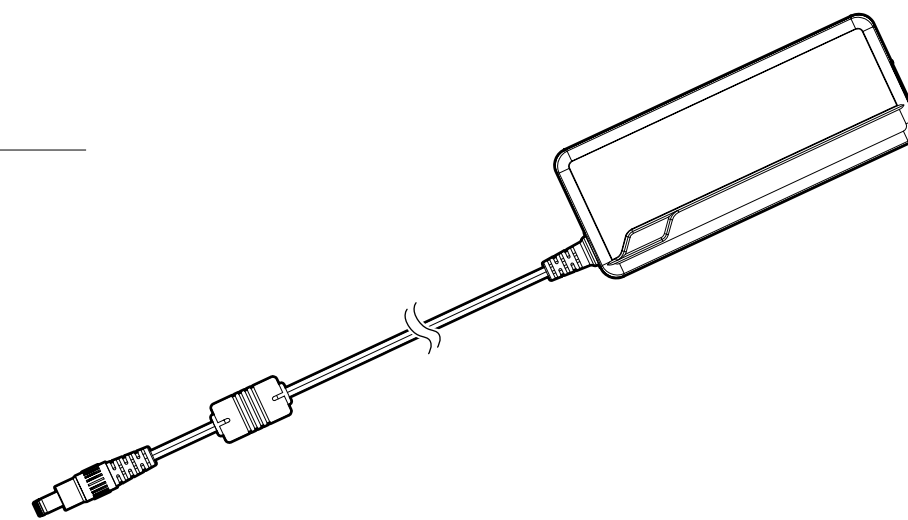

D. HDMI Cable

x1

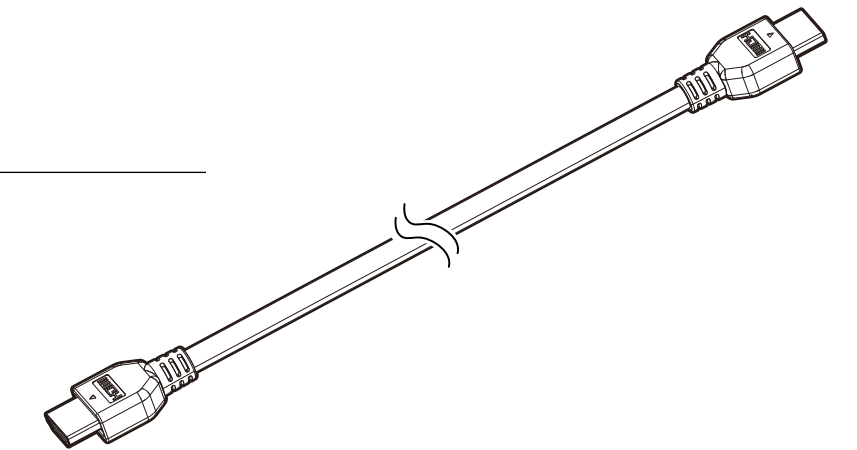

E. DisplayPort Cable

x1

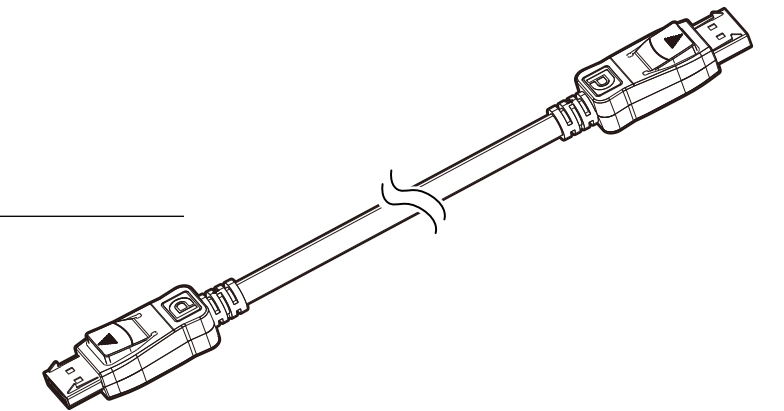

F. USB C / DP Alt

x1

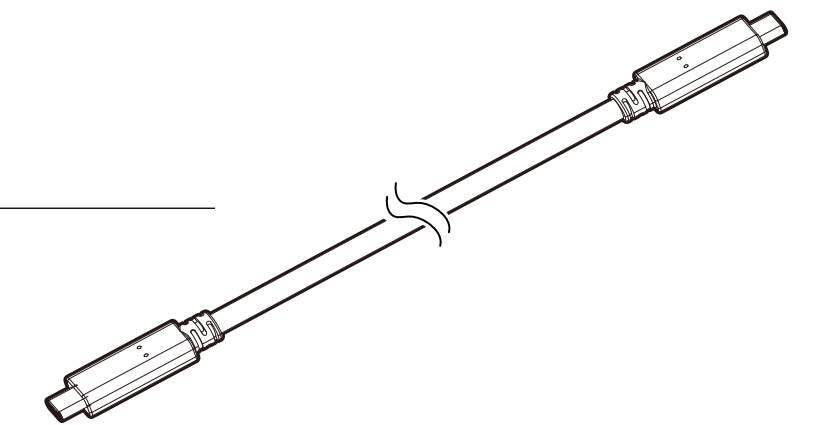

G. USB Type B to USB Type A Cable

x1

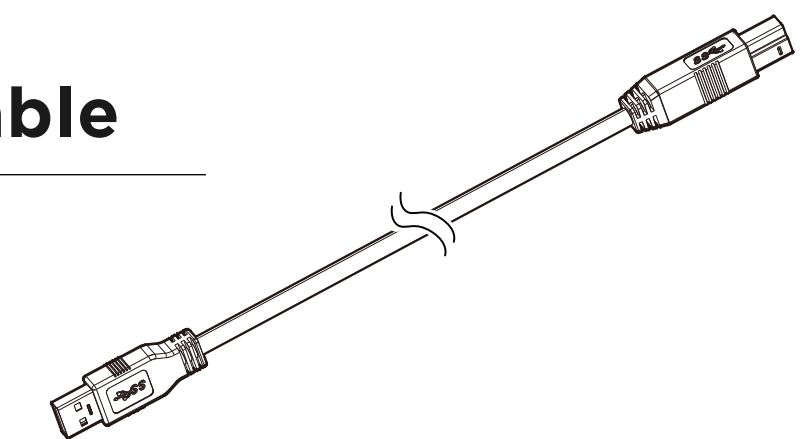

2.2 PACKAGE CONTENTS-MONITOR STAND

CANVAS 25F



H. Stand

x1

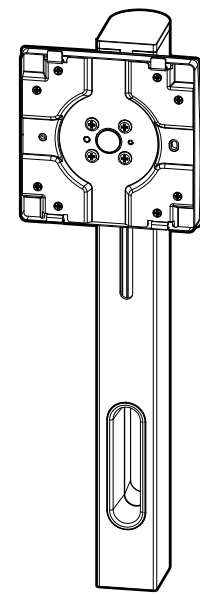

J. Cable Management Clip

x1

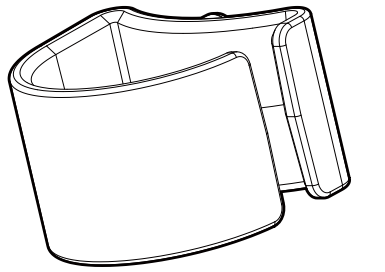

I. Stand Base

x1

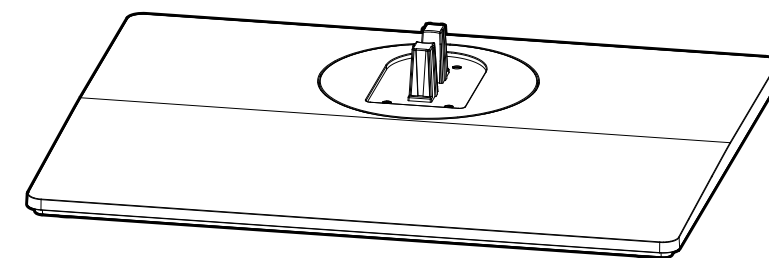

2.3 MONITOR OVERVIEW

CANVAS 25F



A MONITOR PANEL

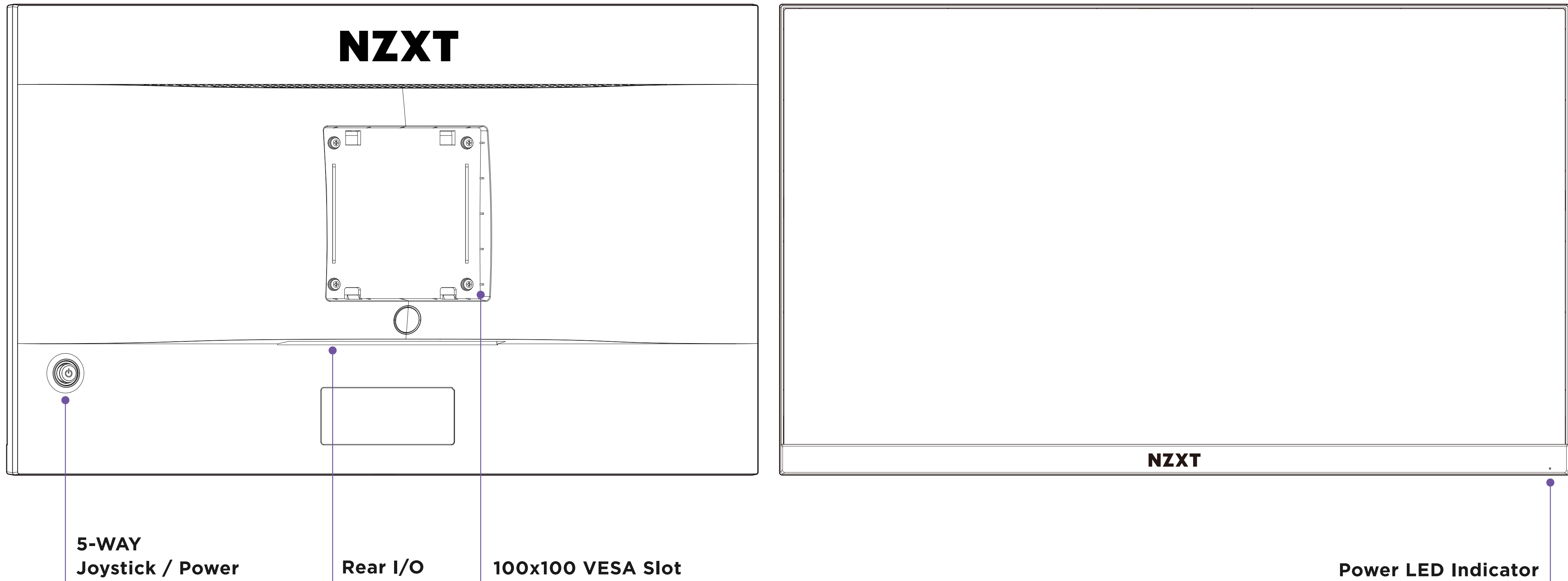



B MONITOR STAND

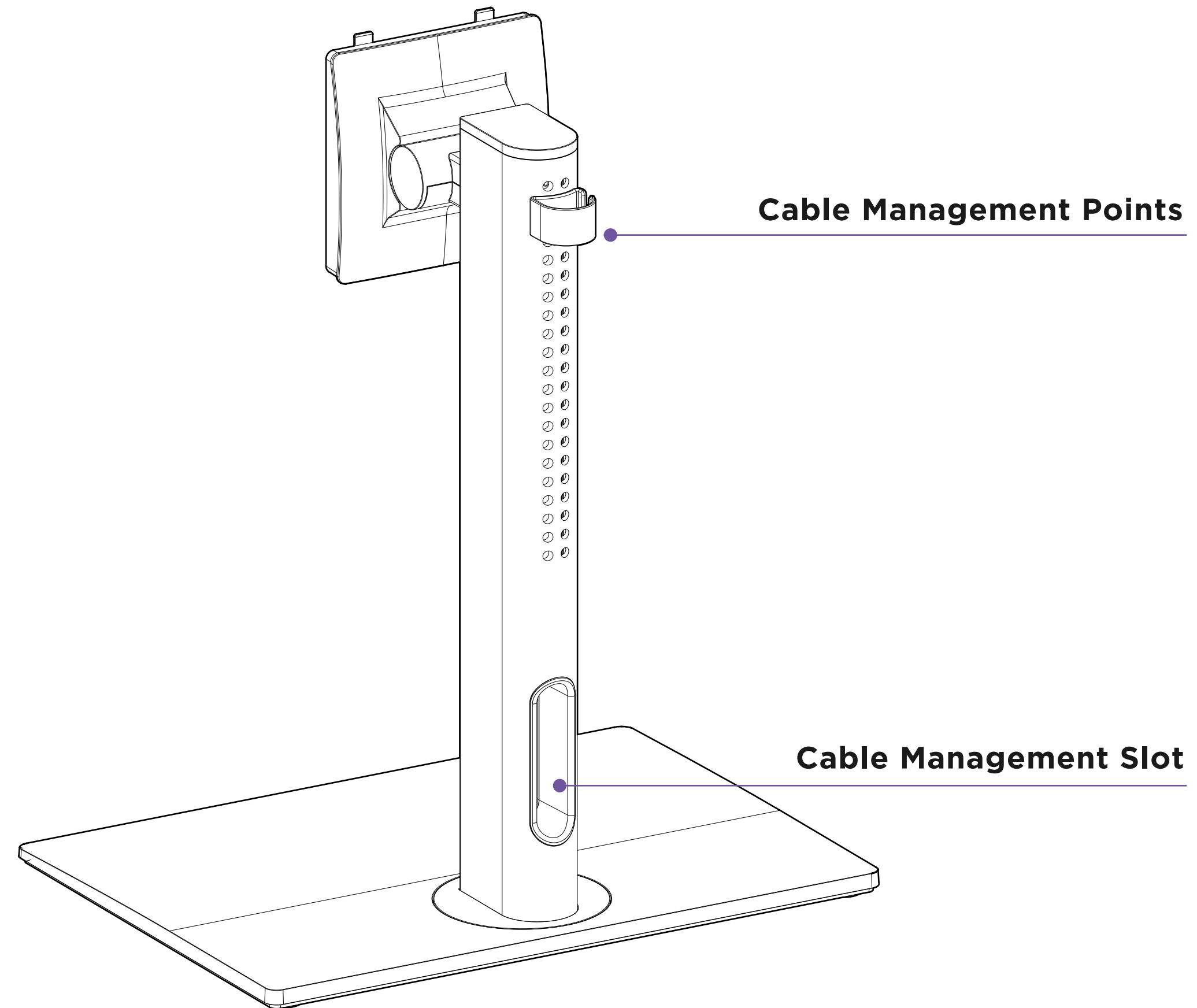

2.4 MONITOR REAR I/O PORTS

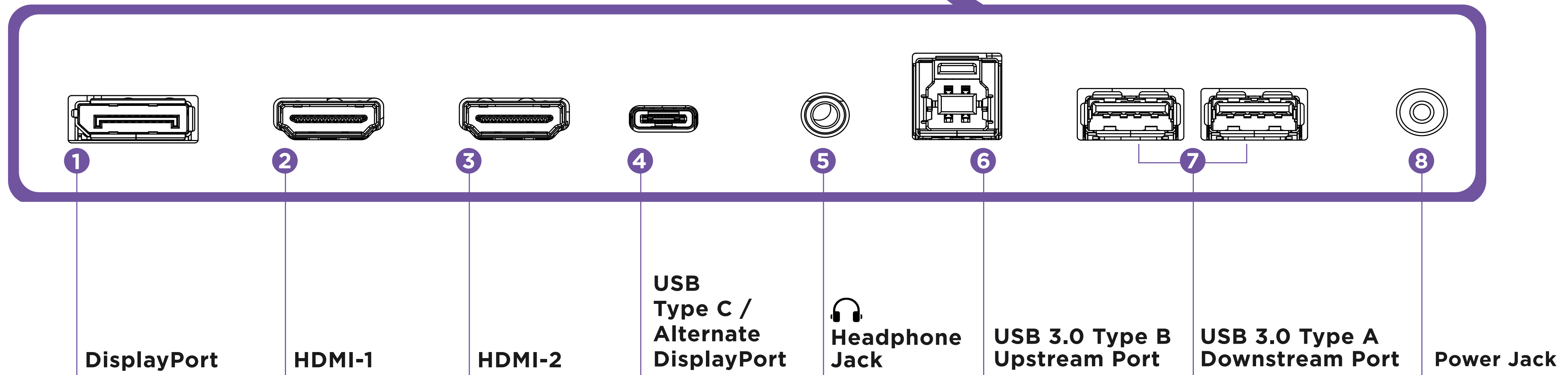
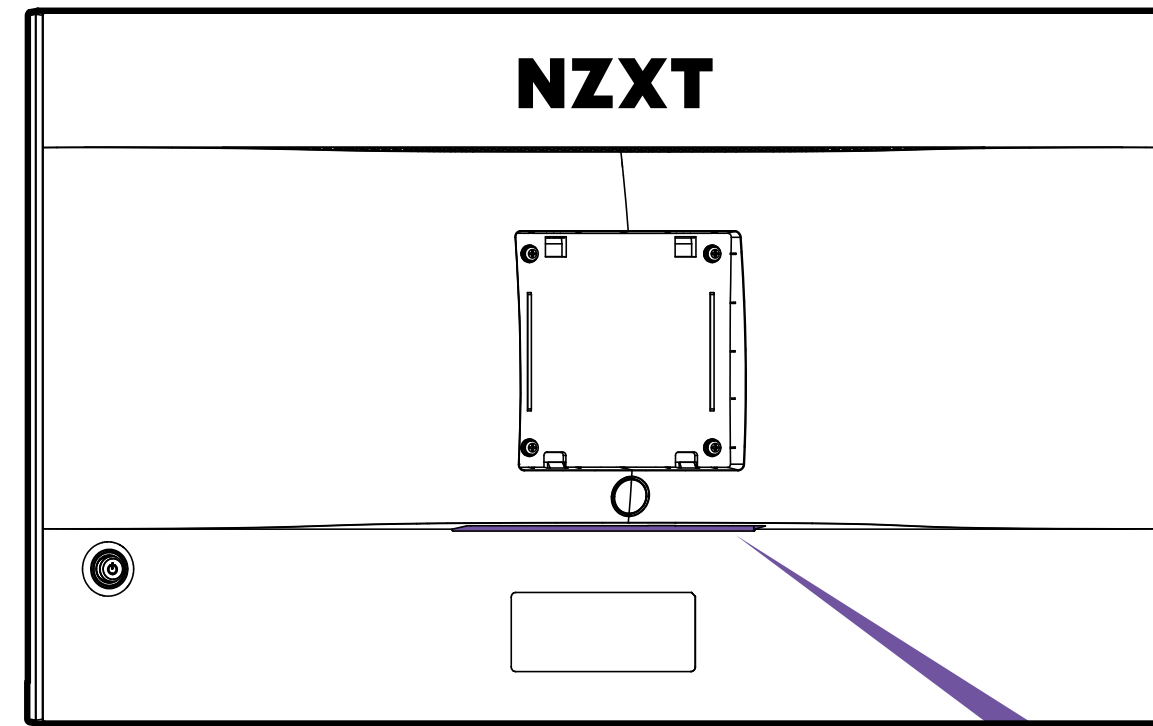

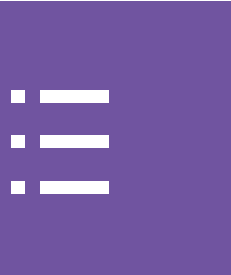

3.1 Monitor Stand Installation13

3.4 Cable Clip Installation..... 23

3.2 Adjusting the Monitor Orientation17

3.5 Monitor Stand Quick Release 24

3.3 Connecting the Monitor to PC..... 18

3.1 MONITOR STAND INSTALLATION



NOTE

- * Place the monitor on a soft, protected surface to avoid scratching the display panel.
- * The holes for installing the stand can also be used for 100x100 VESA compatible mounts.

STEP 1

Carefully hold the base and Insert base to the neck with the guiding structure.

STEP 2

Tighten the attached thumb screw to secure the base.

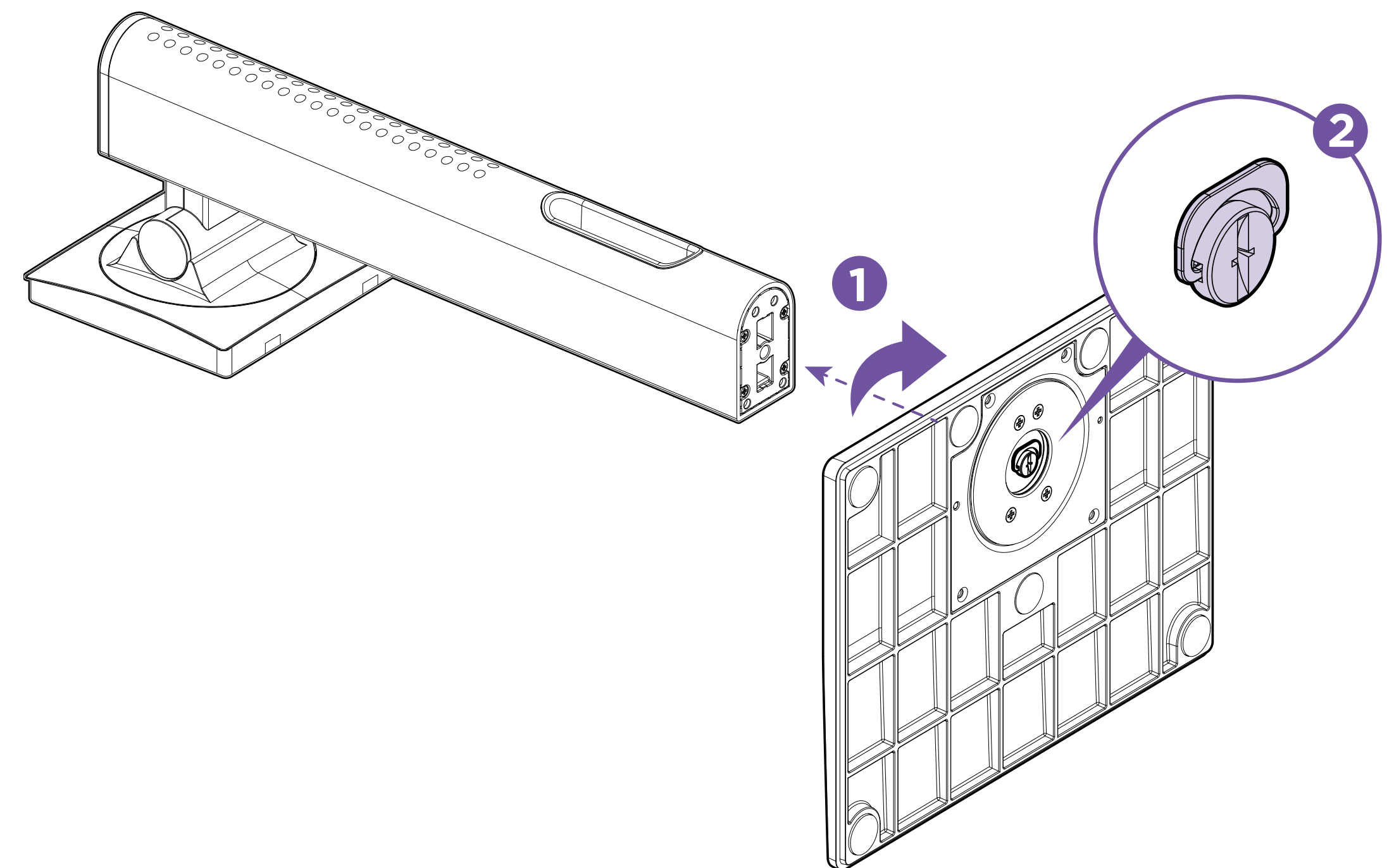



STEP 3

Align and fit the top of the stand to the slot in the rear of the monitor.

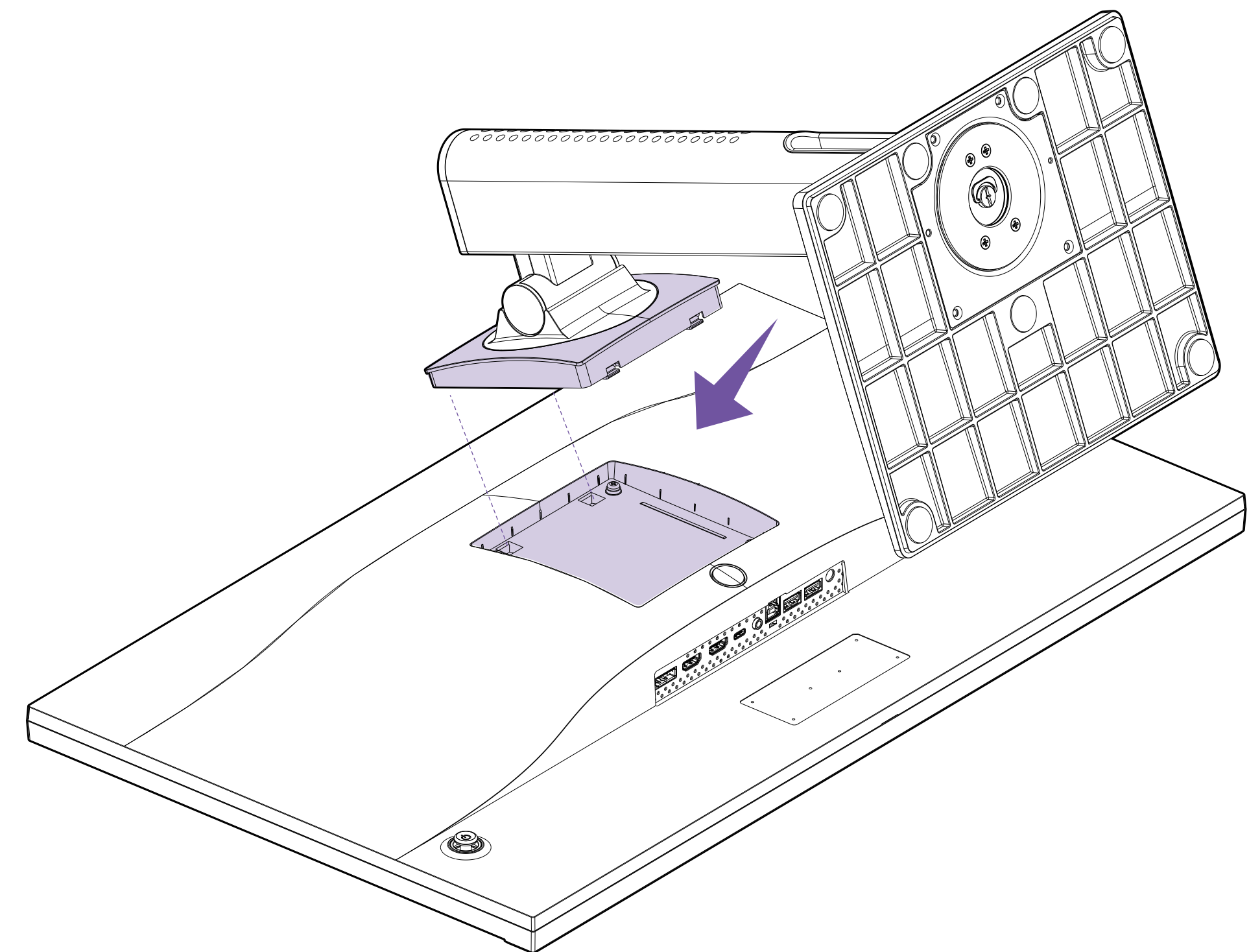



STEP 4

Push down to latch the quick-release mount and lock stand into place. You should hear a clicking sound once it is locked in place.

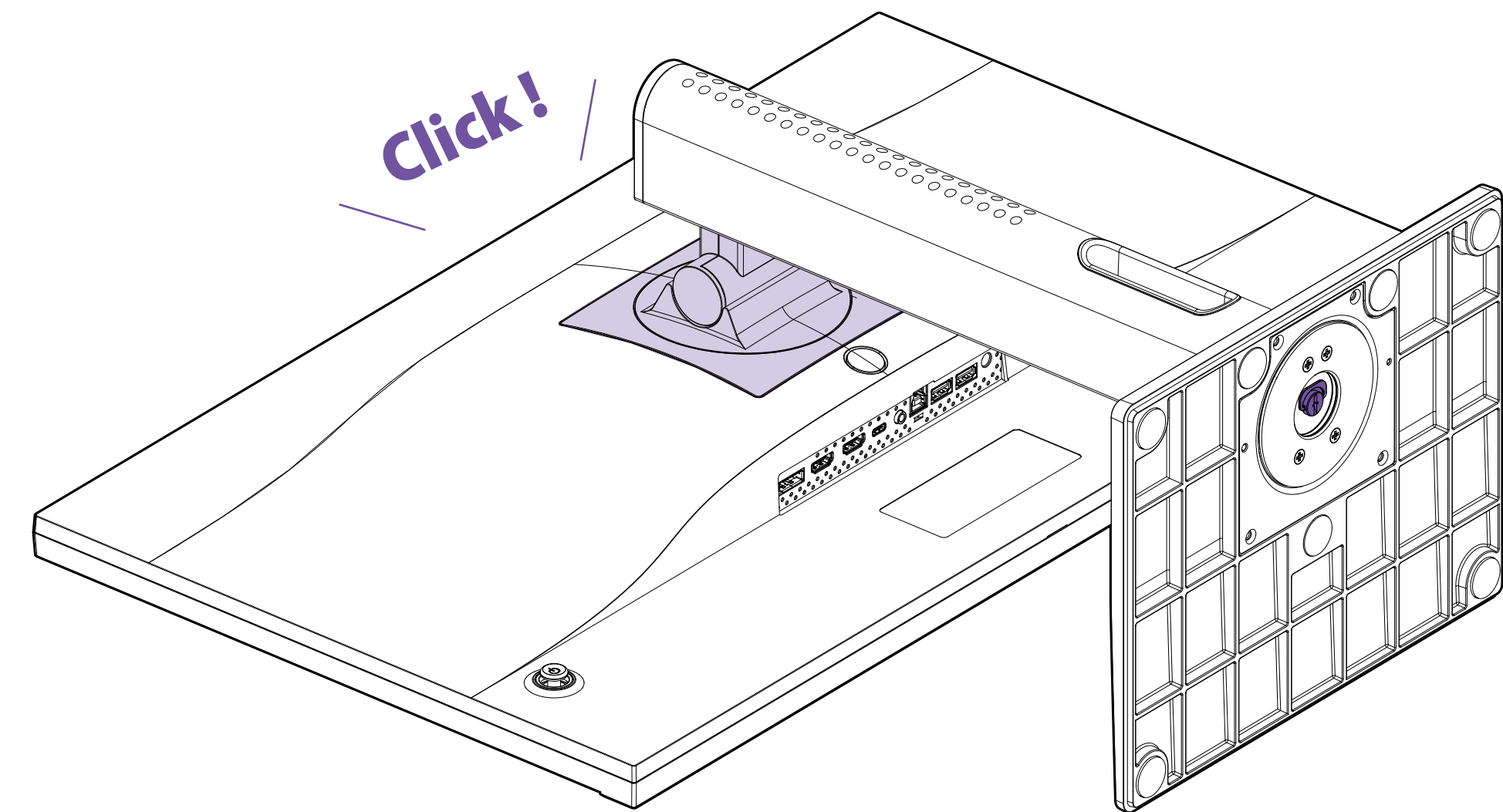

3.1 MONITOR STAND INSTALLATION

CANVAS 25F



STEP 5

Carefully lift up the monitor with two hands. Do not use one hand to hold the unit.

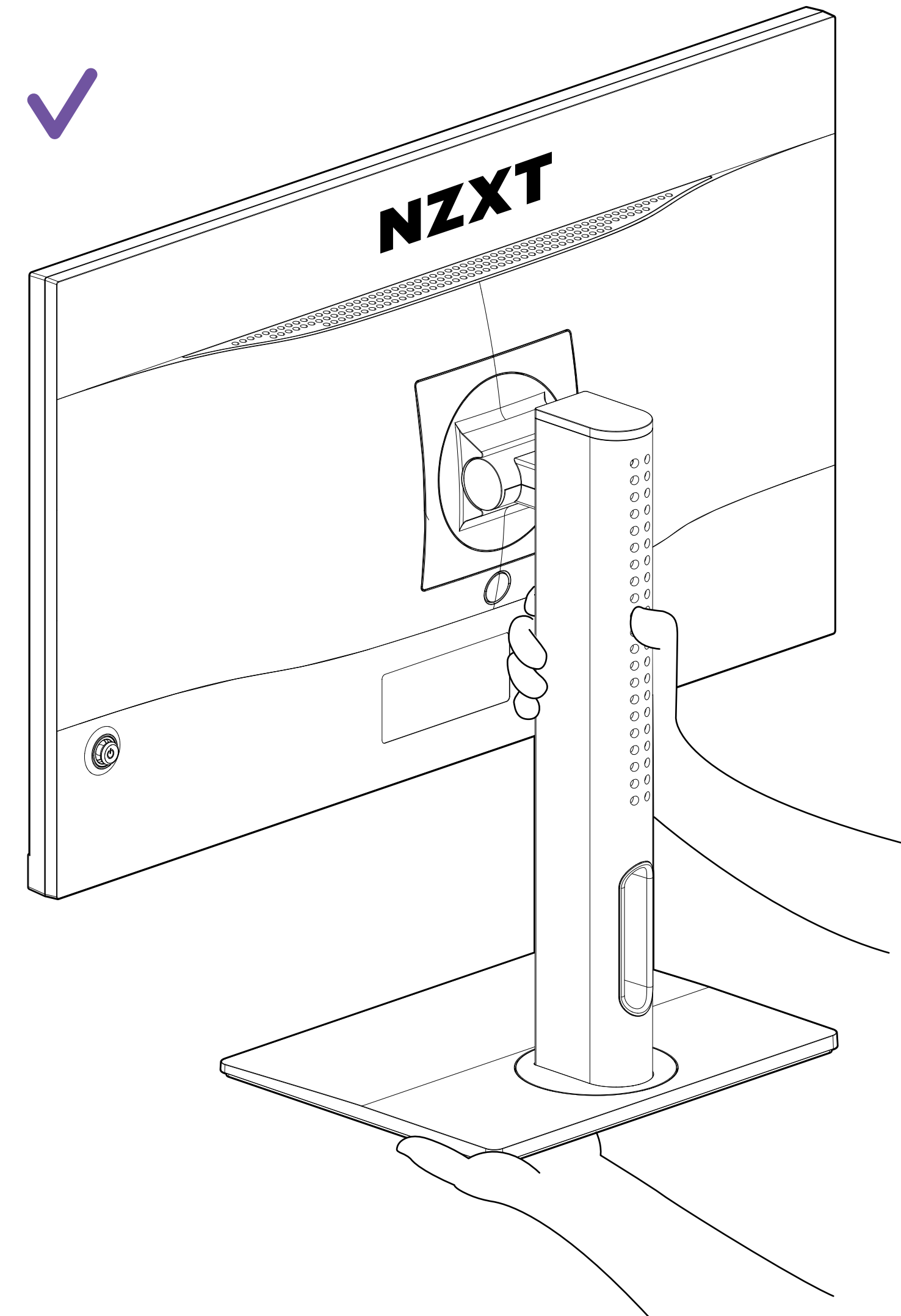
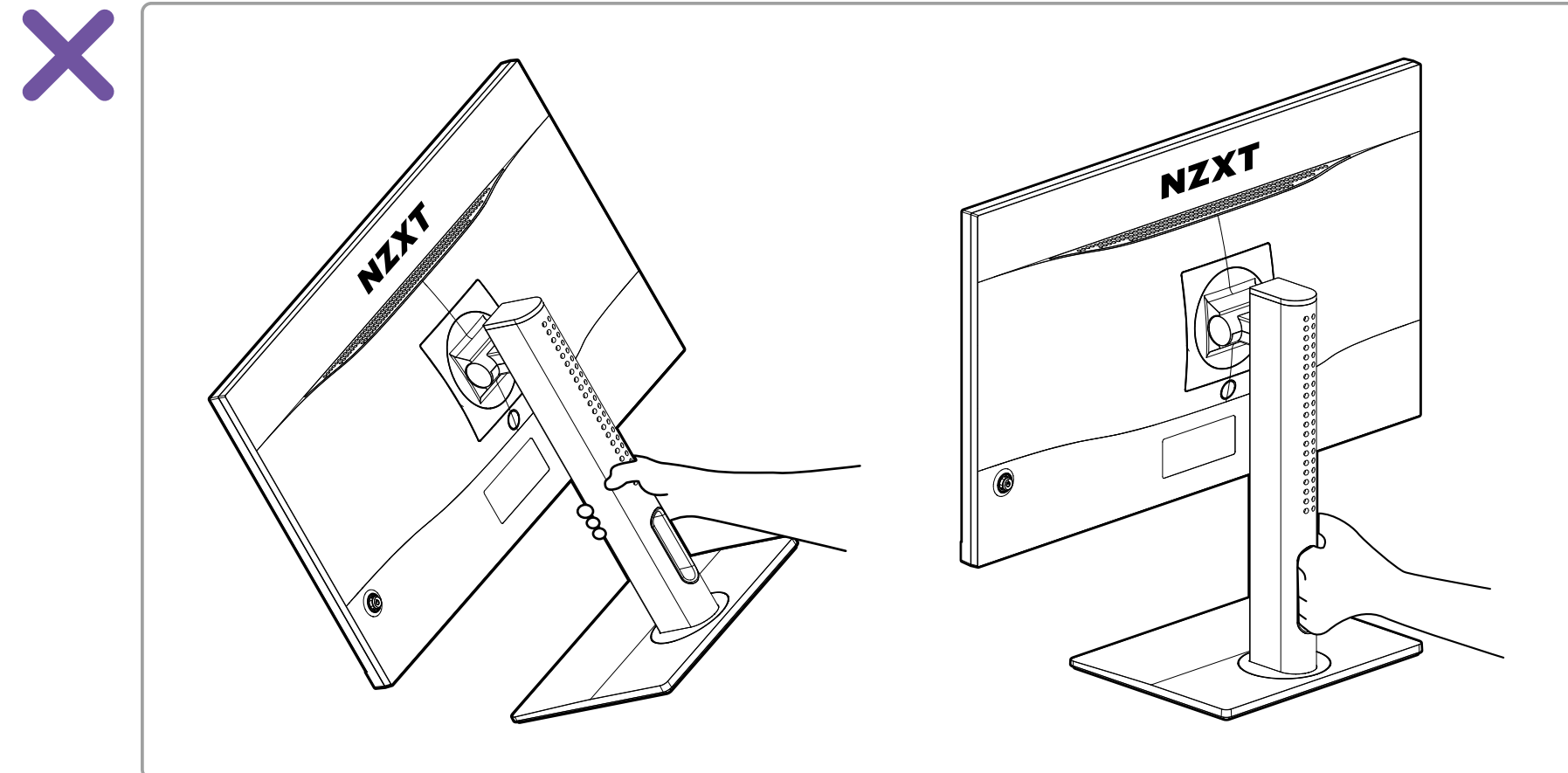

3.2 ADJUSTING THE MONITOR ORIENTATION



To maximize viewing comfort, this monitor includes tilt, swivel, height, and pivot adjustments.

HEIGHT

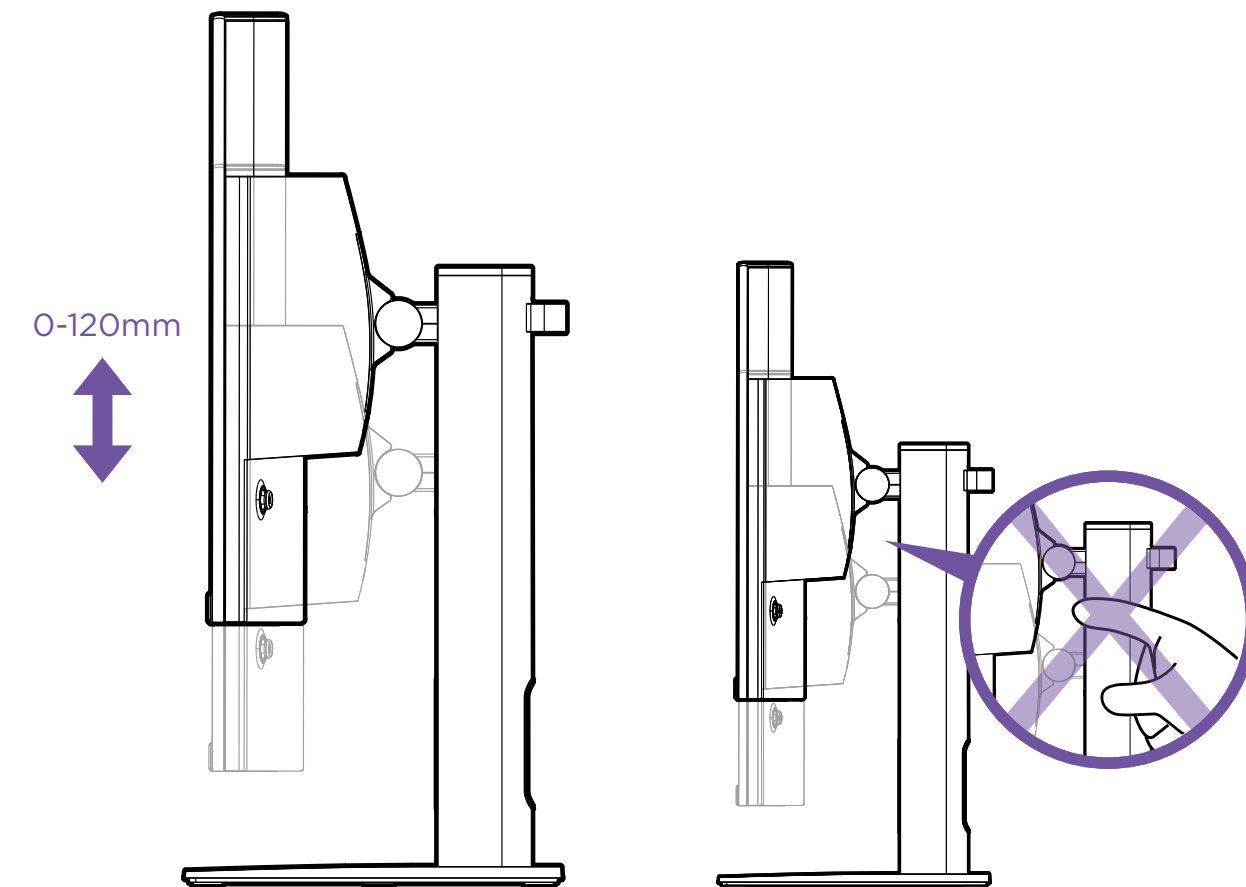

- **Caution** - To avoid injury during height adjustment, be careful when placing your hand behind the panel or around the stand.

- **Caution** - Take extra care to ensure your hand does not get stuck in the height adjustment area. This could injure your hand.

TILT

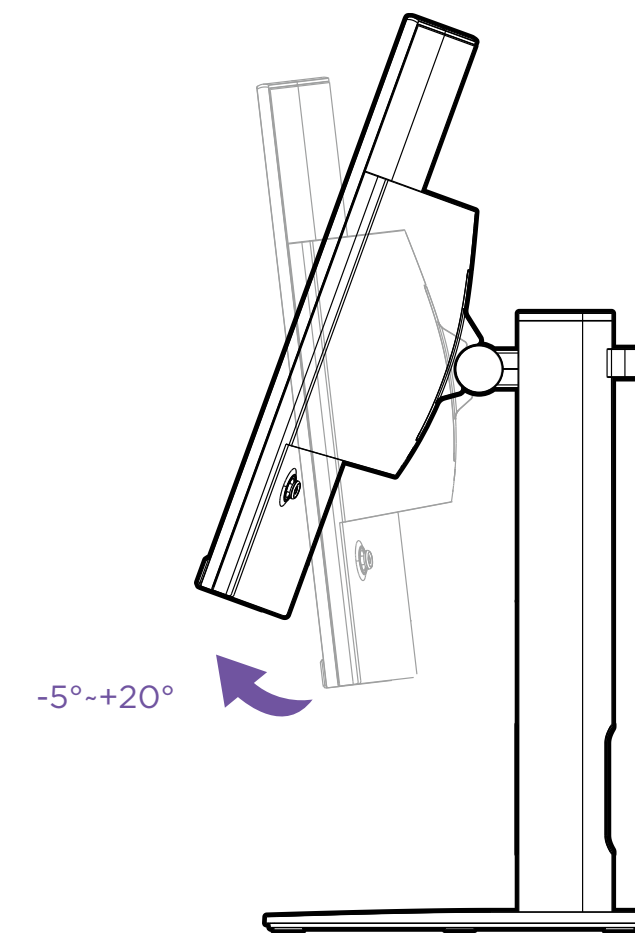

SWIVEL

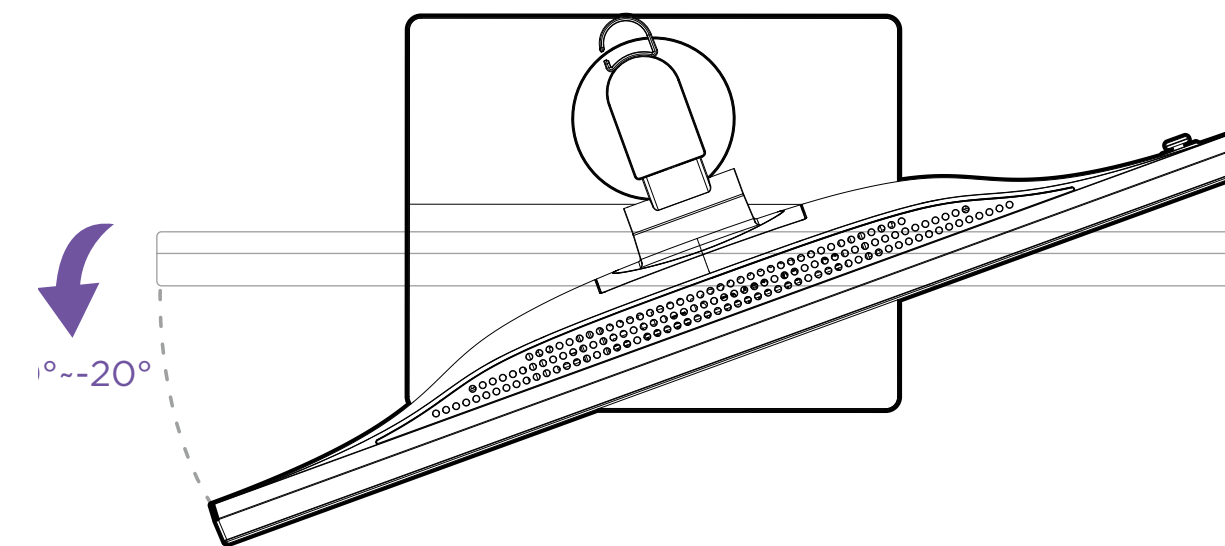

PIVOT

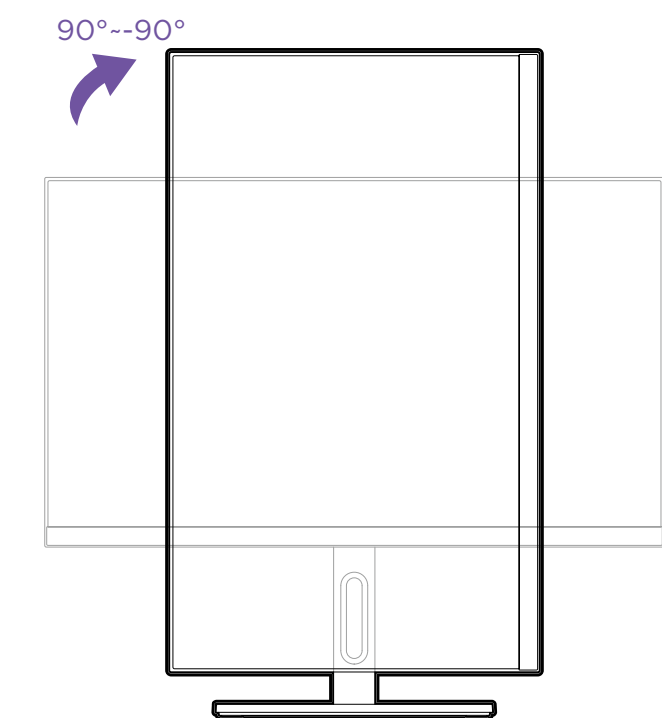

- **Caution** - Tilt monitor panel back 20° before pivoting the panel to prevent the lower corner from scratching the base.

3.3 CONNECTING THE MONITOR TO PC

CANVAS 25F



STEP 1

Make sure your PC is powered off.

STEP 2

Connect the included HDMI/DisplayPort cable from the monitor to your computer.

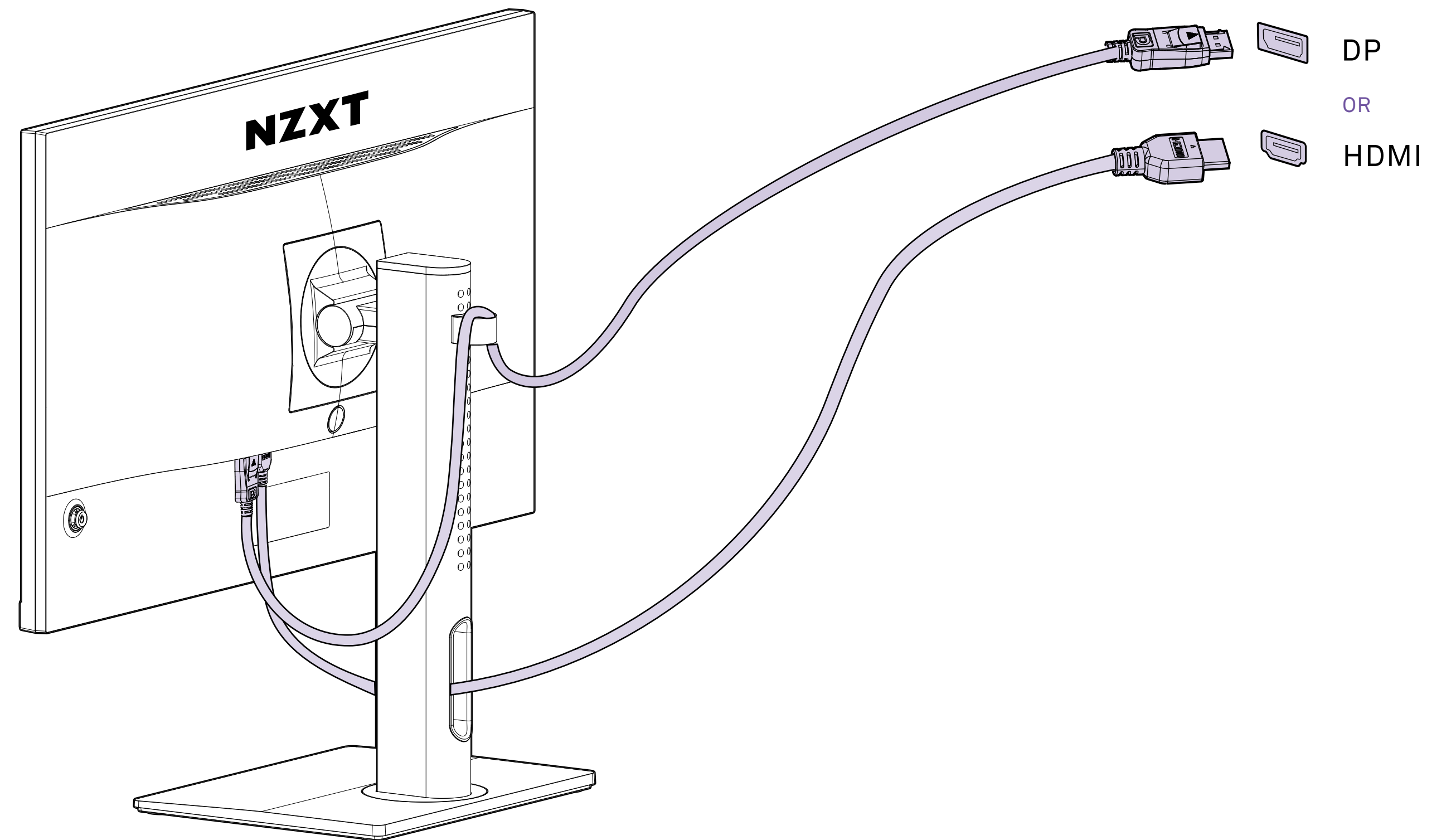

3.3 CONNECTING THE MONITOR TO PC

CANVAS 25F



STEP 3

Connect the monitor power adapter to the power cord.

STEP 4

Connect the power adapter to the monitor power jack.

STEP 5

Plug the power cord into an electrical outlet.

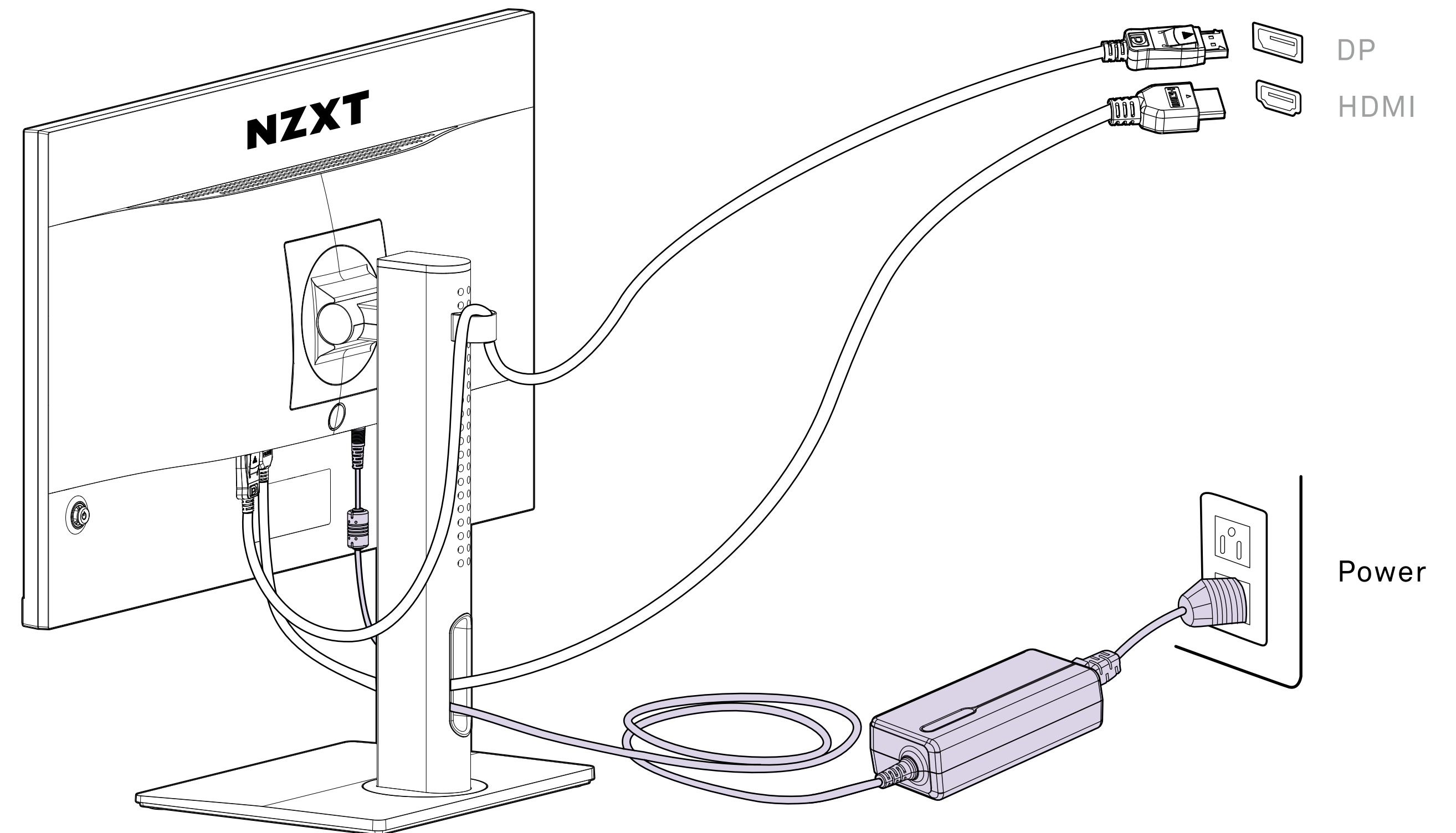

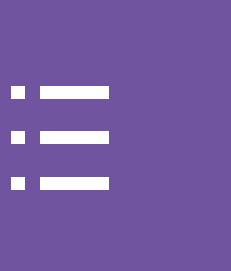

STEP 6

For CAM software connection, use the included USB Type A to B converter cable, connect the Type B connector to the monitor I/O and Type A to your PC.

[Download and install NZXT CAM from nzxt.com/camapp](https://nzxt.com/camapp)

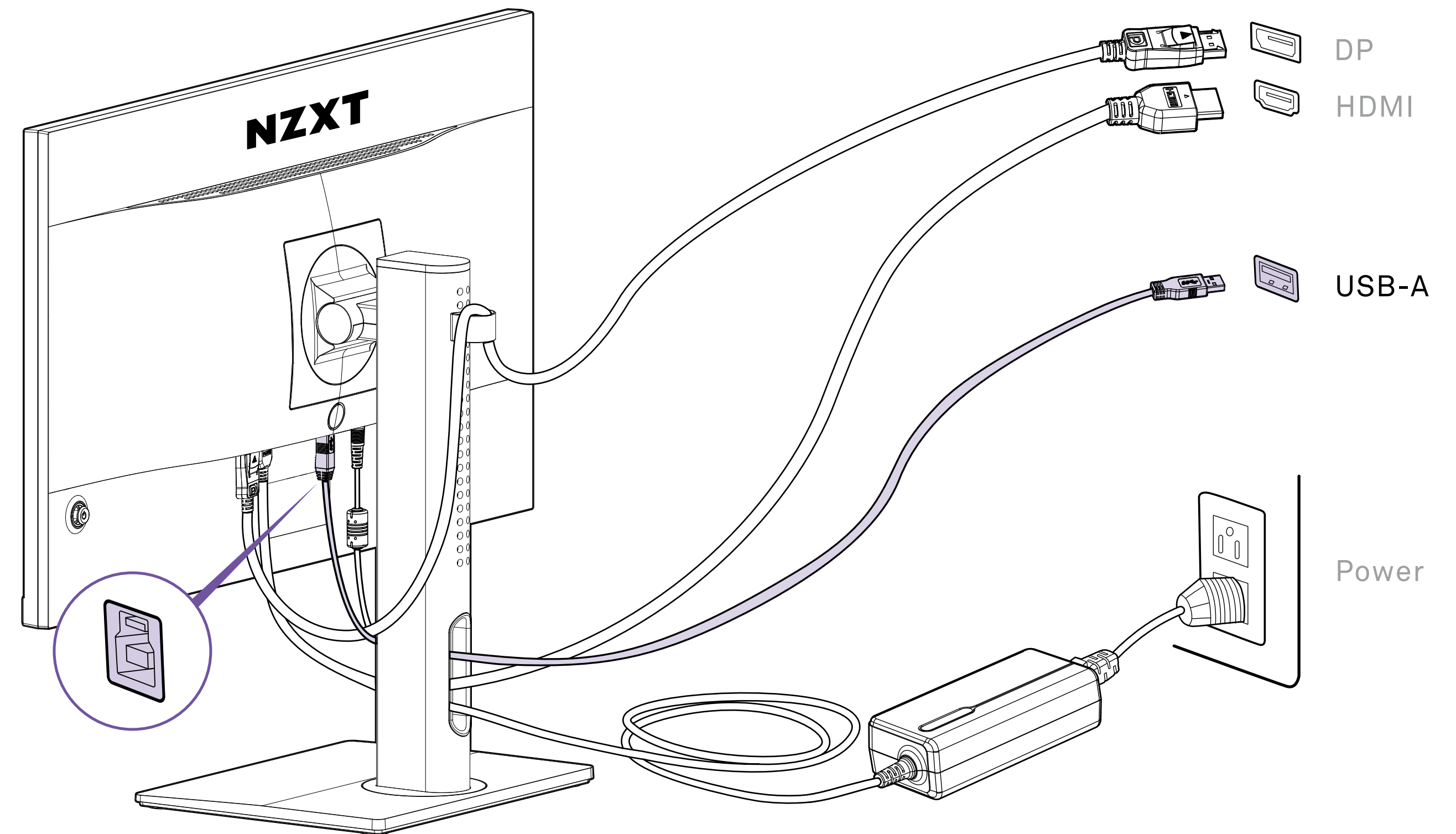



STEP 7

For cable management, use included cable clip and/or cable slot to route cables behind the monitor and desk.

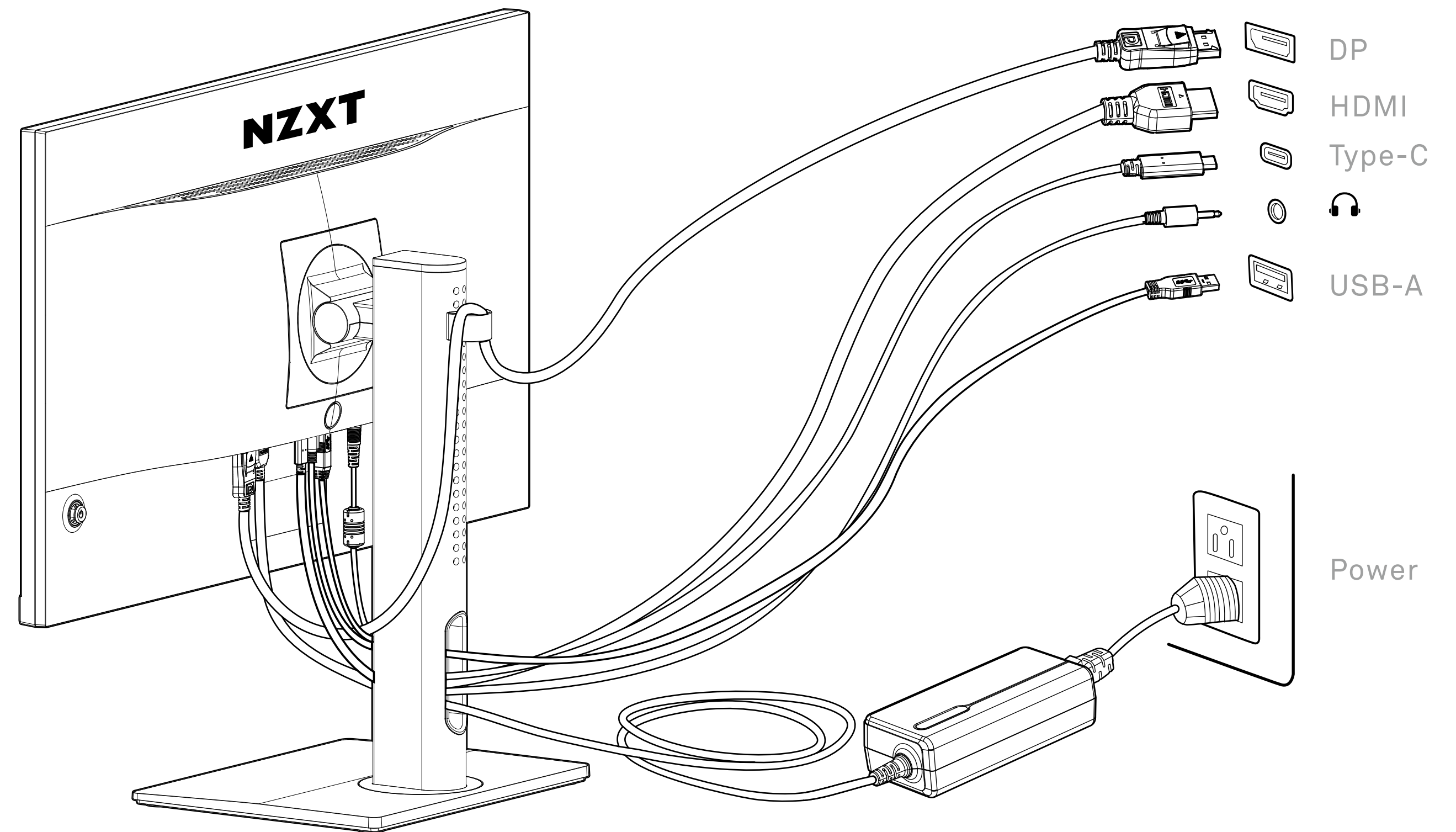

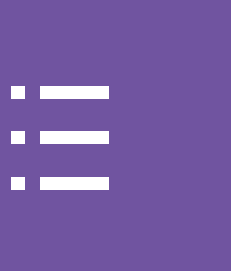

STEP 8

Turn on the monitor.

STEP 9

Power on the computer and monitor will automatically detect signal source(s).

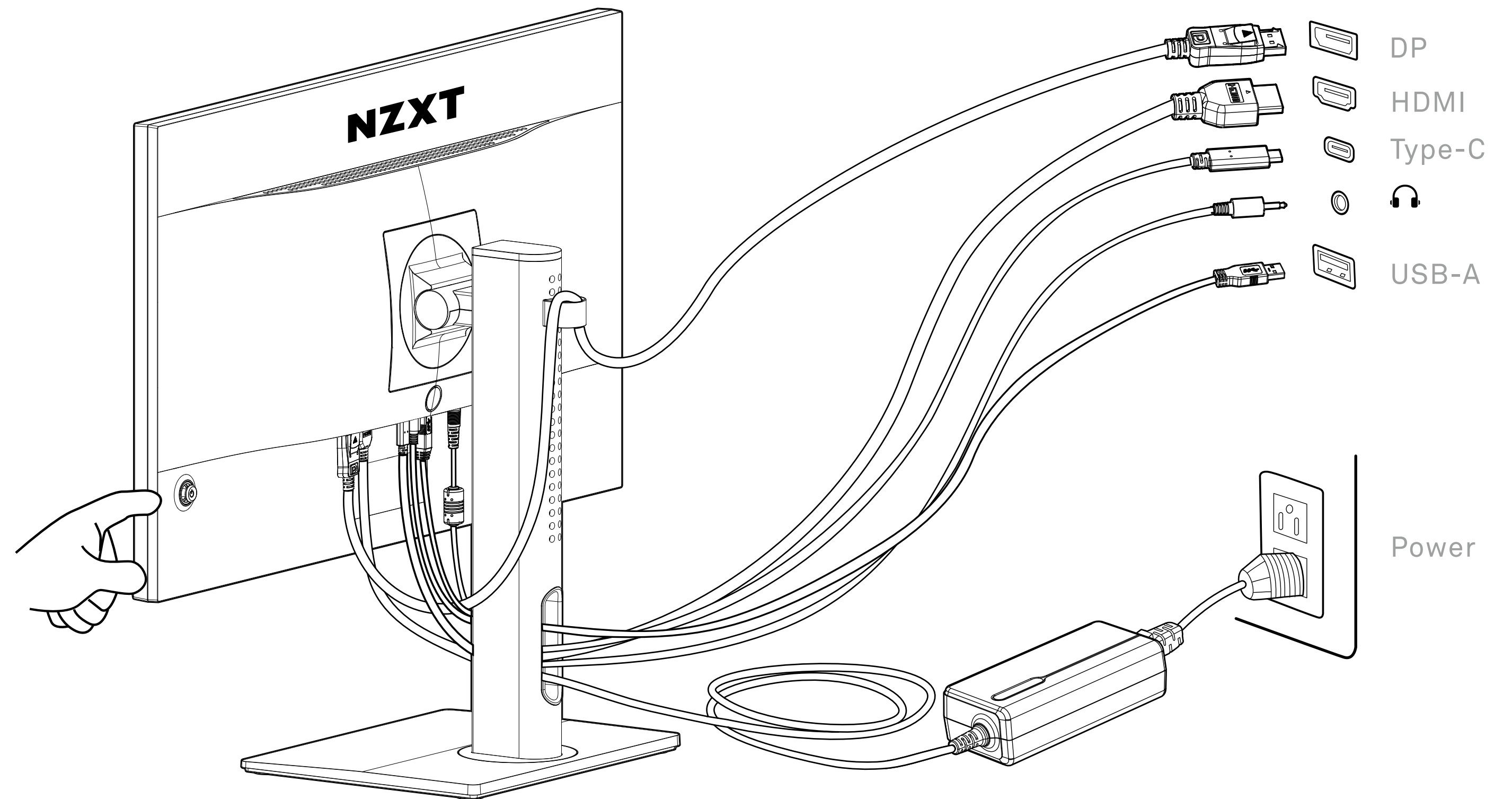

3.4 CABLE CLIP INSTALLATION

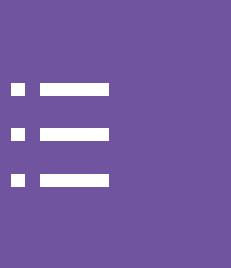

Inserting cable clip into neck back side.

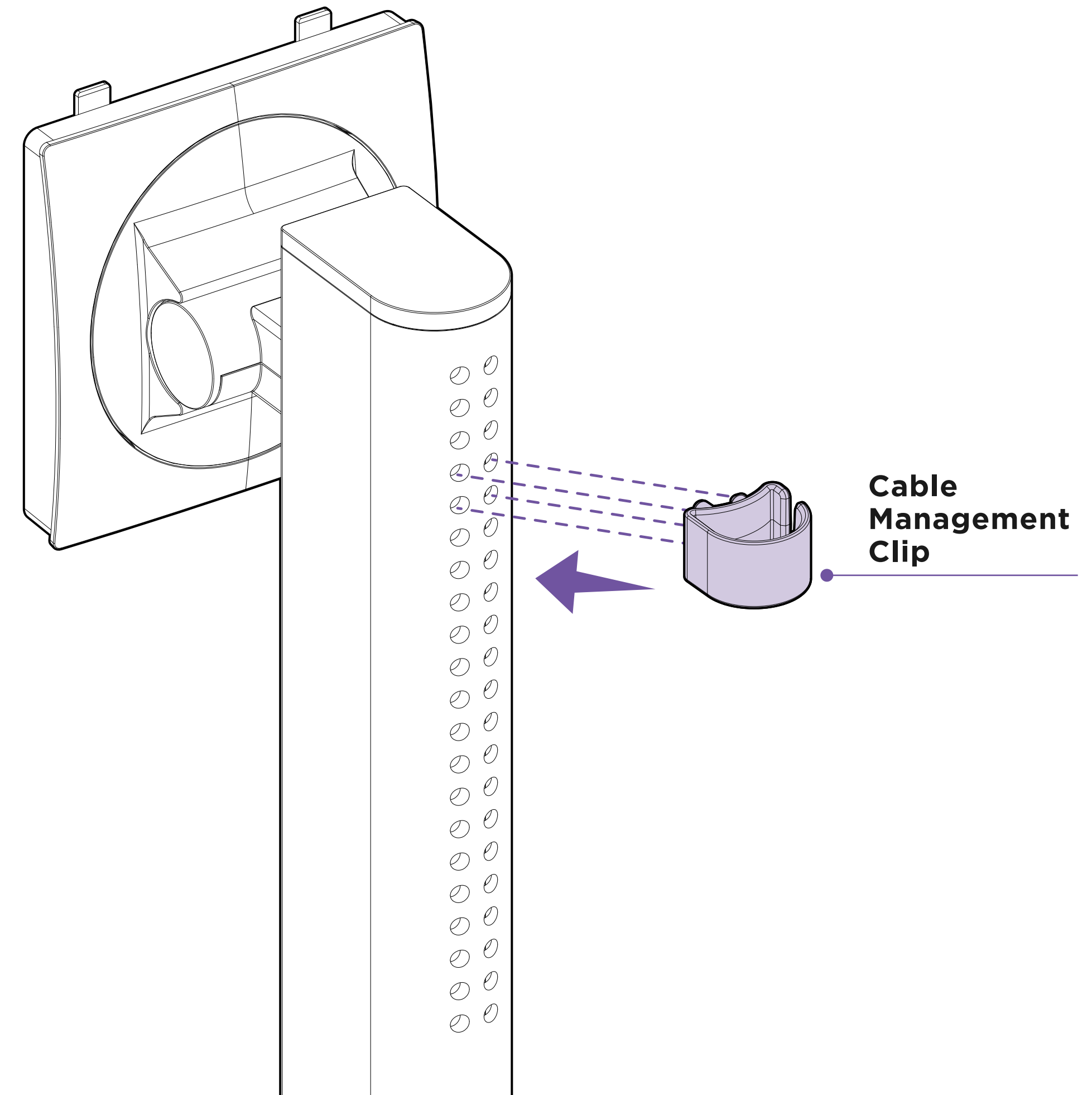

3.5 MONITOR STAND QUICK RELEASE



Press down the quick-release button and tilt back the monitor panel.

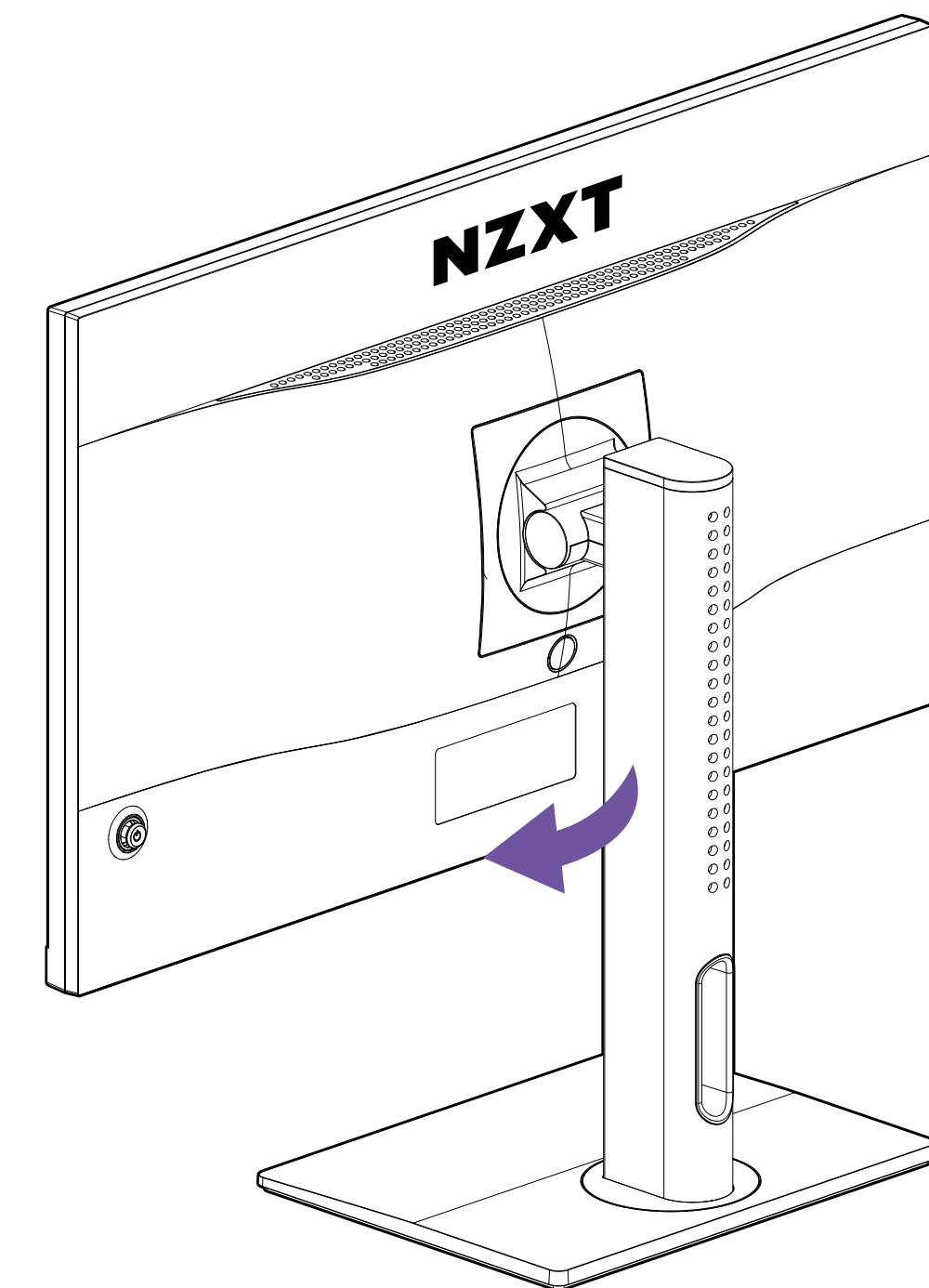
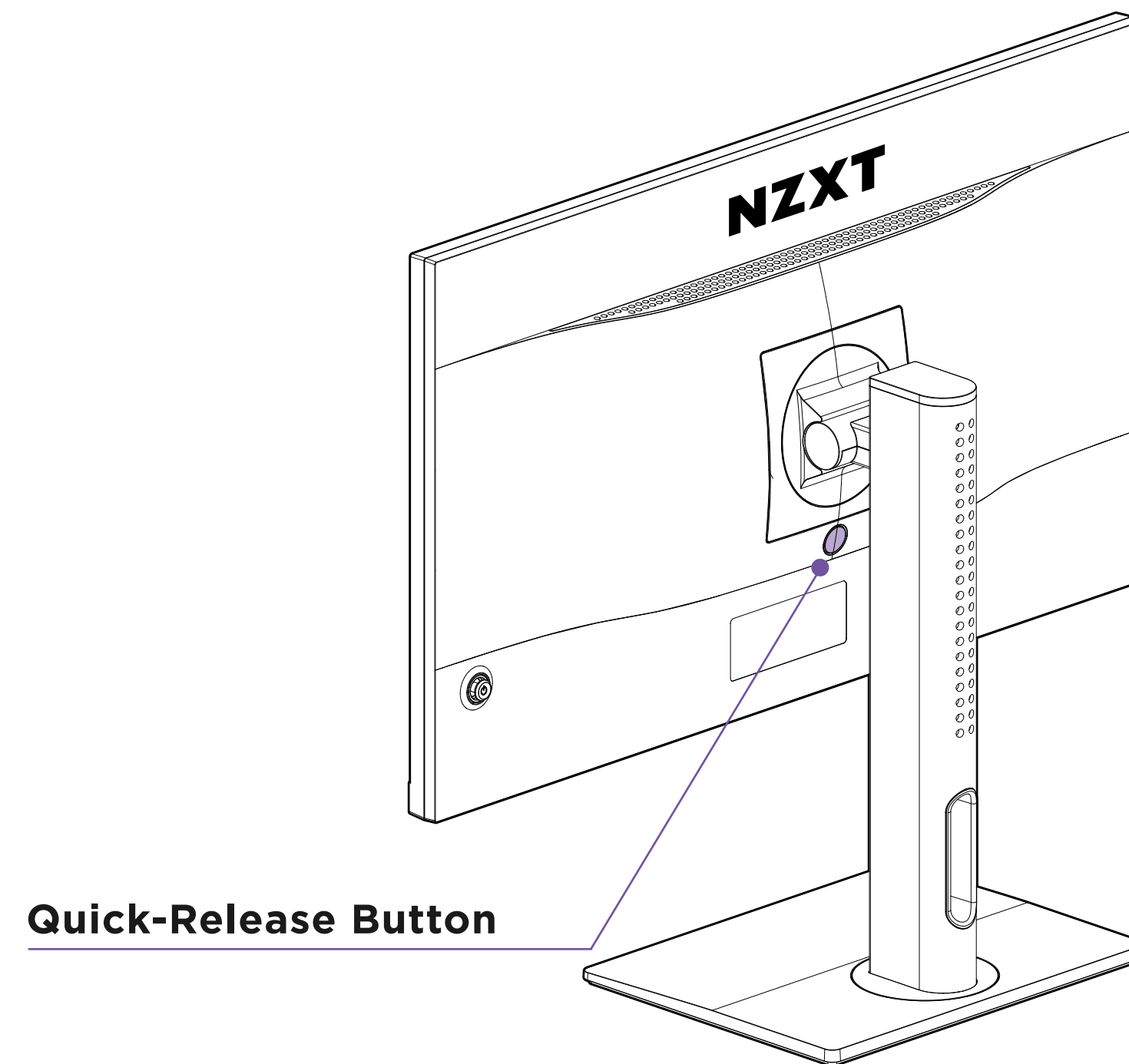

4. MONITOR OSD (ON-SCREEN DISPLAY) SETUP

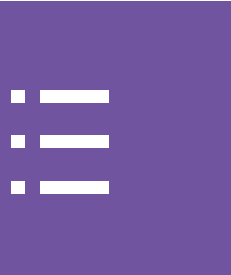

4.1 5-Way Joystick Control Instructions..... 26

4.2 OSD Menu Introduction.....27

4.1 5-WAY JOYSTICK CONTROL INSTRUCTIONS



The monitor comes with a 5-way joystick for power and multi-directional control that navigates the monitor OSD (On-Screen Display) Menu.

POWER ON/OFF - Hold for 3s

SELECT - Press down

QUICK ACCESS

RIGHT - Source

LEFT - Contrast

UP - Brightness

DOWN - Picture Mode

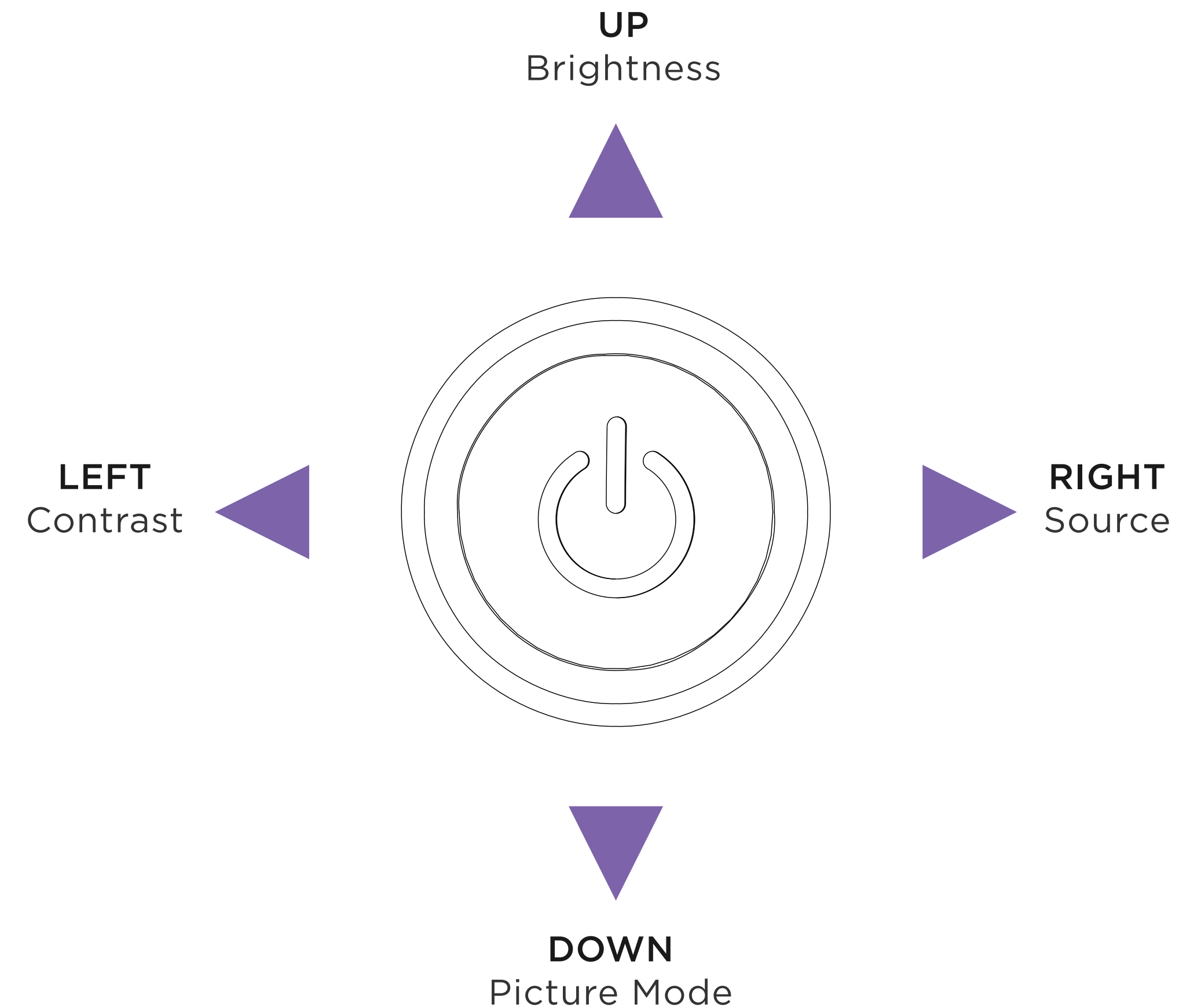

4.2 OSD MENU INTRODUCTION



PICTURE

1st Level Menu	2nd Level Menu	3rd Level Menu	Description	
Picture	Picture Mode	Standard		
		FPS		
		RTS		
		RPG		
		Racing		
		Cinema		
		Professional		
		Night		
		HDR		
	Brightness	0-100%		Brightness can be adjusted in any Mode
	Contrast	0-100%		Contrast can be adjusted in any Mode
	Sharpness	0-100%		<ul style="list-style-type: none"> - Sharpness can be adjusted in any Mode - This improves clarity and details of images
	Color Temperature	Cool / Normal / Warm		<ul style="list-style-type: none"> - Default Color Temperature depends on Picture Mode selected. - Use the Up or Down button to select and preview mode effects. - Press the Center Button to confirm and apply the selected Mode type. - Users can adjust Color Temperature in Customization Mode.
		Customization	R(0-100) G(0-100) B(0-100)	
	Gamma	Off / 2.0 / 2.2 / 2.4		
	Saturation	0-10		
	Response Time	Normal / Fast / Fastest		
Refresh Rate	Off / Upper Right / Upper Left			
MPRT	On / Off			
Low Blue Light	0-10		<ul style="list-style-type: none"> - Low Blue Light protects your eyes against monitor blue light. When enabled, the screen color temperature is adjusted to a more yellow light. - Adjust Low Blue Light in any Mode. - When Reader Mode is On, Low Blue Light will be automatically turned ON. 	
Black Equalizer	0-10			
Aspect Ratio	Auto / 4:3 / 16:9			

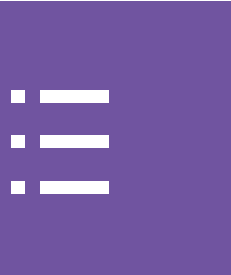

OSD SETTINGS

1st Level Menu	2nd Level Menu	3rd Level Menu	Description
OSD Settings	Language	Chinese (Traditional) / English / French / German / Italian / Spanish / Korean / Japanese / Russian / Portuguese	<ul style="list-style-type: none"> - Default Language is English. - Users can use the Up or Down button to switch to different languages. Center Button to apply new selection. - Language is an independent setting. Users' own language setting will override factory default. When the user sets Reset to Yes, Language will not be changed.
	OSD Transparency	0% / 20% / 40% / 60% / 80%	Adjust OSD Transparency in any Mode
	OSD TimeOut	10-60 sec	Adjust OSD TimeOut in any Mode

SYSTEM SETTINGS

1st Level Menu	2nd Level Menu	3rd Level Menu	Description
System Settings	Free Sync	On / Off	<ul style="list-style-type: none"> - Default is OFF. FreeSync is a united switch; if HDMI is set to OFF, each input source will also be set to OFF. - Only DisplayPort can enable G-Sync compatibility for NVIDIA graphics cards.
	LED	On / Off	Default is ON. Controls LED indicator light on or off
	Source Detection	Auto / Manual	Automatically or manually switching between input sources.
	Mute	On / Off	Default is OFF. Controls 3.5mm audio jack on/off
	Volume	0-100	Default is 50. Controls 3.5mm audio jack volume
	Reset All	On / Off	Reset or restore settings to original OSD Default in any Mode.



INPUT SOURCE

1st Level Menu	2nd Level Menu	3rd Level Menu	Description
Input Source	HDMI 1		
	HDMI 2		
	DisplayPort		
	Type C		

MONITOR INFORMATION

1. Source 2. Resolution 3. Refresh Rate 4. FreeSync Premium 5. HDR 6. FW Version

5. CAM SOFTWARE SETUP

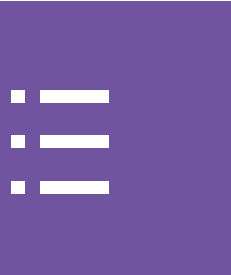

5.1 Download CAM31

5.2 CAM Introduction..... 32



NZXT CAM

Download and install NZXT CAM from nzxt.com/camapp.

Descargue e instale NZXT CAM en nzxt.com/camapp.

Téléchargez et installez NZXT CAM depuis nzxt.com/camapp.

laden Sie NZXT CAM von nzxt.com/camapp herunter und installieren Sie die Software.

Scaricare e installare NZXT CAM da nzxt.com/camapp.

Baixe e instale o NZXT CAM de nzxt.com/camapp.

загрузите и установите приложение NZXT CAM со страницы nzxt.com/camapp.

nzxt.com/camapp 에서 NZXT CAM을 다운로드하여 설치하십시오.

NZXT CAMは nzxt.com/camapp からダウンロード・インストール可能です。

請从：nzxt.com/camapp 下载并安装 NZXT CAM 软件。

請從 nzxt.com/camapp 下載並安裝 NZXT CAM。

5.2 CAM INTRODUCTION



NZXT CAM allows users to turn their PC gaming setup into a synchronous and fully immersive ecosystem. This cohesive and intuitive software is built for PC monitoring, customization, and performance tweaking. With NZXT CAM, users can adjust Canvas monitor settings directly, using custom profiles that can sync to certain games or time of day.

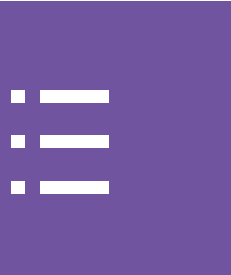

6.1 SPECIFICATIONS..... A-2

6.2 Troubleshooting (FAQ)..... A-3

6.3 Supported Timing List..... A-4

6.4 NZXT Global Warranty Policy..... A-5

6.5 Support and Service..... A-11

6.6 限用物质及元素列表/限用物質及元素清單 A-11

6.6 Regulatory Notices..... A-14

6.7 Battery Information..... A-15

6.8 WEEE Statement..... A-16

6.9 Revision History A-20

6.1 SPECIFICATIONS

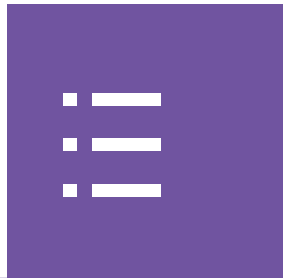

MODEL	NZXT CANVAS 25F GAMING MONITOR
PANEL SIZE	25"
ASPECT RATIO	16:9
FLAT / CURVED	FLAT
MAX. RESOLUTION	FHD 1920X1080
LCM BRIGHTNESS (TYP.)	400 CD/M ²
BEZEL TYPE	BORDERLESS
ACTIVE DISPLAY AREA (H*V)	543.744 (H) X 302.616 (V)
COLOR GAMUT	DCI-P3 94%, RGB 99%
VIEWING ANGLE (H/V)	178° / 178° (TYP.)
DISPLAY COLORS	16.7M
RESPONSE TIME	1MS (GTG)
ADAPTIVE SYNC.	AMD FREESYNC PREMIUM
PANEL REFRESH RATE	240HZ
HDR	VESA DISPLAYHDR™ 400
VIDEO INPUT	2X HDMI 2.0 1X DP 1.2
USB PORTS	2X USB 3.0 TYPE A 1X USB 3.0 TYPE B 1X USB TYPE C (DISPLAYPORT ALT)
HEADPHONE OUT	3.5MM X1
POWER TYPE	EXTERNAL ADAPTER
ADAPTER POWER INPUT	100-240VAC, 50-60HZ,1.6A MAX
ADAPTER POWER OUTPUT	19V = 3.42 A

CHASSIS COLORS	BLACK / WHITE
POWER SAVING MODE	0.5W
POWER OFF MODE	0.3W
VESA COMPATIBILITY	100 X 100 MM SCREW TYPE: M4 X 15MM
VIEWING	ANTI-FLICKER BLUE LIGHT PROTECTION ANTI-GLARE BLUR REDUCTION
TILT ADJUSTMENT	5° ~ -20°
SWIVEL ADJUSTMENT	20° ~ -20°
HEIGHT ADJUSTMENT	0-120MM
PIVOT	90° ~ -90°
DIMENSION WITH STAND (WXHxD)	558.1MM X 509.3MM X 219.7MM
DIMENSION WITHOUT STAND (WXHxD)	558.1MM X 332.2MM X 68.4MM
BOX DIMENSION (WXHxD)	660X450X130MM
NET WEIGHT (PANEL ONLY)	3.43KG
NET WEIGHT (STAND ONLY)	2.6KG
VOLTAGE RATING	19V 3.42A
ENVIRONMENT	OPERATING: TEMPERATURE: 0°C TO 40°C HUMIDITY: 20% TO 90%, NON-CONDENSING ALTITUDE: 0 ~ 5000M STORAGE TEMPERATURE: -20°C TO 60°C HUMIDITY: 10% TO 90%, NON-CONDENSING

6.2 TROUBLESHOOTING (FAQ)



Problem	Possible Solution
Power LED is not ON	<ul style="list-style-type: none"> - Check if the adapter or power cord is correctly and firmly connected or out. - If the screen is working without power LED on, check MENU > Other Setting > LED, make sure it is turned to ON.
The power LED light is on but there is no screen image	<ul style="list-style-type: none"> - Check if the operating system had entered sleep or power-save mode. Press the joystick or move the mouse to wake it up. - Check if the signal cable (HDMI/DisplayPort/Type-C) is well connected, and confirm another end of the output cable has been firmly connected to the computer input port (graphics card). Unplug and plug 2-terminals again to ensure all pins aren't bent. - Replace signal cable (HDMI/DisplayPort/Type-C) to take a cross-test - Check MENU > Input Source, and switch to the correct source. - Connect monitor to the other computers (PC/Notebook) to confirm whether it is normal - Reset the monitor, MENU > Other Setting > Reset All.
Screen image is too light or dark	<ul style="list-style-type: none"> - Check and set MENU > Image > Brightness, the larger value means lighter.
Screen image bounces or a wave pattern is present in the image	<ul style="list-style-type: none"> - Check and set MENU > Image > Sharpness. - Check MENU > Image > Response time and switch Normal/Fast/Fastest mode. - Check MENU > Image > MPRT and switch OFF/ON. - Check MENU > Other Setting > FreeSync Premium and switch OFF/ON and check if the abnormal display disappeared.
Screen image has color defects (white does not look white)	<ul style="list-style-type: none"> - Check MENU > Image > Color Temperature and switch Cool/Normal/Warm. - Check and set Color Temperature > Customization > R/G/B. - If it still does not look "white" enough, reset the monitor, MENU > Other Setting > Reset All, and try the above actions again.
Setting and changing display refresh rate	<ul style="list-style-type: none"> - Default display refresh rate setting is 60Hz - To change display refresh rate settings: <ul style="list-style-type: none"> • Right click on Windows desktop • Select "Display Settings" from the drop down • Scroll down and select "Advanced Display Settings" • Select the display to view or change the settings for it • Select Refresh Rate setting • Note - To use display in portrait mode, follow above steps to change display refresh rate settings prior to changing display orientation to portrait mode. You will not be able to change the refresh rate settings while in portrait mode.

6.3 SUPPORTED TIMING LIST

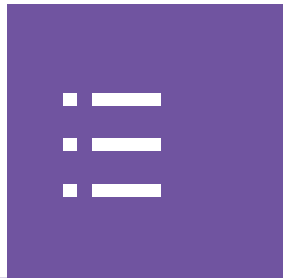

Standard	Resolution	HDMI 1	HDMI 2	DisplayPort	Type C
VGA	640x480@60Hz	<input checked="" type="checkbox"/>	<input checked="" type="checkbox"/>	<input checked="" type="checkbox"/>	<input checked="" type="checkbox"/>
	640x480@67Hz	<input checked="" type="checkbox"/>	<input checked="" type="checkbox"/>	<input checked="" type="checkbox"/>	<input checked="" type="checkbox"/>
	640x480@72Hz	<input checked="" type="checkbox"/>	<input checked="" type="checkbox"/>	<input checked="" type="checkbox"/>	<input checked="" type="checkbox"/>
	640x480@75Hz	<input checked="" type="checkbox"/>	<input checked="" type="checkbox"/>	<input checked="" type="checkbox"/>	<input checked="" type="checkbox"/>
Dos-Mode	720x480@60Hz	<input checked="" type="checkbox"/>	<input checked="" type="checkbox"/>	<input checked="" type="checkbox"/>	<input checked="" type="checkbox"/>
	720x576@50Hz	<input checked="" type="checkbox"/>	<input checked="" type="checkbox"/>	<input checked="" type="checkbox"/>	<input checked="" type="checkbox"/>
SVGA	800x600@56Hz	<input checked="" type="checkbox"/>	<input checked="" type="checkbox"/>	<input checked="" type="checkbox"/>	<input checked="" type="checkbox"/>
	800x600@60Hz	<input checked="" type="checkbox"/>	<input checked="" type="checkbox"/>	<input checked="" type="checkbox"/>	<input checked="" type="checkbox"/>
	800x600@72Hz	<input checked="" type="checkbox"/>	<input checked="" type="checkbox"/>	<input checked="" type="checkbox"/>	<input checked="" type="checkbox"/>
	800x600@75Hz	<input checked="" type="checkbox"/>	<input checked="" type="checkbox"/>	<input checked="" type="checkbox"/>	<input checked="" type="checkbox"/>
XGA	1024x768@60Hz	<input checked="" type="checkbox"/>	<input checked="" type="checkbox"/>	<input checked="" type="checkbox"/>	<input checked="" type="checkbox"/>
	1024x768@70Hz	<input checked="" type="checkbox"/>	<input checked="" type="checkbox"/>	<input checked="" type="checkbox"/>	<input checked="" type="checkbox"/>
	1024x768@75Hz	<input checked="" type="checkbox"/>	<input checked="" type="checkbox"/>	<input checked="" type="checkbox"/>	<input checked="" type="checkbox"/>
SXGA	1280x768@60Hz	<input checked="" type="checkbox"/>	<input checked="" type="checkbox"/>	<input checked="" type="checkbox"/>	<input checked="" type="checkbox"/>
	1280x768@75Hz	<input checked="" type="checkbox"/>	<input checked="" type="checkbox"/>	<input checked="" type="checkbox"/>	<input checked="" type="checkbox"/>
WXGA+	1440x900@60Hz	<input checked="" type="checkbox"/>	<input checked="" type="checkbox"/>	<input checked="" type="checkbox"/>	<input checked="" type="checkbox"/>
WSXGA+	1680x1050@60Hz	<input checked="" type="checkbox"/>	<input checked="" type="checkbox"/>	<input checked="" type="checkbox"/>	<input checked="" type="checkbox"/>
Full HD	1920x1080@60Hz	<input checked="" type="checkbox"/>	<input checked="" type="checkbox"/>	<input checked="" type="checkbox"/>	<input checked="" type="checkbox"/>
	1920x1080@85Hz	<input type="checkbox"/>	<input type="checkbox"/>	<input type="checkbox"/>	<input type="checkbox"/>
	1920x1080@120Hz	<input checked="" type="checkbox"/>	<input checked="" type="checkbox"/>	<input checked="" type="checkbox"/>	<input checked="" type="checkbox"/>

Standard	Resolution	HDMI 1	HDMI 2	DisplayPort	Type C
Full HD QHD	1920x1080@144Hz	<input type="checkbox"/>	<input type="checkbox"/>	<input type="checkbox"/>	<input type="checkbox"/>
	1920x1080@165Hz	<input checked="" type="checkbox"/>	<input checked="" type="checkbox"/>	<input checked="" type="checkbox"/>	<input checked="" type="checkbox"/>
	1920x1080@200Hz	<input checked="" type="checkbox"/>	<input checked="" type="checkbox"/>	<input checked="" type="checkbox"/>	<input checked="" type="checkbox"/>
	1920x1080@240Hz	<input checked="" type="checkbox"/>	<input checked="" type="checkbox"/>	<input checked="" type="checkbox"/>	<input checked="" type="checkbox"/>
Video Timing Resolution	480P@60Hz	<input checked="" type="checkbox"/>	<input checked="" type="checkbox"/>	<input checked="" type="checkbox"/>	<input checked="" type="checkbox"/>
	576P@50Hz	<input checked="" type="checkbox"/>	<input checked="" type="checkbox"/>	<input checked="" type="checkbox"/>	<input checked="" type="checkbox"/>
	720P@50Hz	<input checked="" type="checkbox"/>	<input checked="" type="checkbox"/>	<input checked="" type="checkbox"/>	<input checked="" type="checkbox"/>
	720P@60Hz	<input checked="" type="checkbox"/>	<input checked="" type="checkbox"/>	<input checked="" type="checkbox"/>	<input checked="" type="checkbox"/>
	720P@100Hz	<input checked="" type="checkbox"/>	<input checked="" type="checkbox"/>	<input checked="" type="checkbox"/>	<input checked="" type="checkbox"/>
	720P@120Hz	<input checked="" type="checkbox"/>	<input checked="" type="checkbox"/>	<input checked="" type="checkbox"/>	<input checked="" type="checkbox"/>
	1080i	<input type="checkbox"/>	<input type="checkbox"/>	<input type="checkbox"/>	<input type="checkbox"/>
	1080P@50Hz	<input checked="" type="checkbox"/>	<input checked="" type="checkbox"/>	<input checked="" type="checkbox"/>	<input checked="" type="checkbox"/>
	1080P@60Hz	<input checked="" type="checkbox"/>	<input checked="" type="checkbox"/>	<input checked="" type="checkbox"/>	<input checked="" type="checkbox"/>
	1080P@100Hz	<input checked="" type="checkbox"/>	<input checked="" type="checkbox"/>	<input checked="" type="checkbox"/>	<input checked="" type="checkbox"/>
	1080P@120Hz	<input checked="" type="checkbox"/>	<input checked="" type="checkbox"/>	<input checked="" type="checkbox"/>	<input checked="" type="checkbox"/>
	2160P@50Hz	<input checked="" type="checkbox"/>	<input checked="" type="checkbox"/>	<input checked="" type="checkbox"/>	<input checked="" type="checkbox"/>
2160P@60Hz	<input checked="" type="checkbox"/>	<input checked="" type="checkbox"/>	<input checked="" type="checkbox"/>	<input checked="" type="checkbox"/>	

6.4 NZXT GLOBAL WARRANTY POLICY

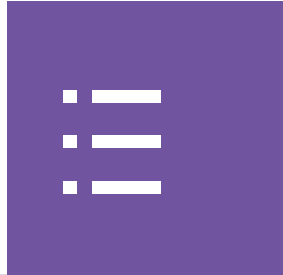

This NZXT Global Warranty Policy governs the sale of products by NZXT to you.

I. WARRANTY LENGTH

Any replacement product will be covered under warranty for the remainder of the warranty period or thirty days, whichever is longer. Proof of purchase is required for warranty service.

II. WHO IS PROTECTED

The Warranty covers only NZXT products purchased by the original consumer.

NEW NZXT PRODUCT	WARRANTY LENGTH FOR PARTS
Computer Cases	2 Years
Temperature Meters	2 Years
Fans	2 Years
Lighting	2 Years
Accessories	2 Years
Kraken M Coolers	3 Years
Headset/Headphone	2 Years
Headset/Headphone Storage	2 Years
Mixer	2 Years
Motherboards	3 Years
Gold Power Supply	10 Years
Bronze Power Supply	5 Years
Kraken X/Z Coolers	6 Years
Mini ITX Case with PSU, AIO, and Riser Card	3-year warranty on case, riser card, and AIO. 10-year warranty on PSU.
Monitors	3 Years
REFURBISHED NZXT PRODUCT	WARRANTY LENGTH FOR PARTS
All NZXT Certified Refurbished Products	1 Years



III. WHAT IS AND IS NOT COVERED

Please note that our warranty is not an unconditional guarantee. If the product, in NZXT's reasonable opinion, malfunctions within the warranty period, NZXT will provide you at its sole discretion with a repaired or replacement product, either new or refurbished, with a similar function that is equal or greater in value depending on supply.

Our warranty does not cover the following:

- any product or serial number/warranty sticker modification applied without permission from NZXT;
- any damage that is not a manufacturing defect;
- damage, deterioration or malfunction resulting from: accident, abuse, misuse, neglect, fire, water, lightning, or other acts of nature, unauthorized product modification or failure to follow instructions included with the product;
- improper installation, unauthorized alterations or modifications, or repair or attempted repair by anyone not authorized by NZXT;
- shipping or transport damage (claims must be made with the carrier);
- normal wear and tear.

NZXT does not warrant that this product will meet your requirements. It is your responsibility to determine the suitability of this product for your purpose. For NZXT Store orders, we cover two way return shipping for all exchanges and returns. For all other authorized dealers, NZXT Support does not cover return shipping and only covers one way shipping from NZXT back to the end user for exchanges. Two way expedited shipping is provided for all PSUs covered under the Less Than Three program, indiscriminate of purchase location, provided the location is an approved NZXT reseller.

IV. EXCLUSION OF DAMAGES (DISCLAIMER)

NZXT's sole obligation and liability under this warranty is limited to the repair or replacement of a defective product with either a new or refurbished product with a similar function that is equal or greater in value at our option. NZXT shall not, in any event, be liable for any incidental or consequential damage, including but not limited to damages resulting from interruption of service and loss of data, business, or for liability in tort relating to this product or resulting from its use or possession.



V. LIMITATIONS OF IMPLIED WARRANTIES

Here are no other warranties, expressed or implied, including but not limited to those of merchantability or fitness for a particular purpose. The duration of implied warranties is limited to the warranty length specified in Paragraph I.

VI. TO OBTAIN TECHNICAL SUPPORT

If you have already referenced your product owner's manual and still need help, you may contact us by phone at +1 (800) 228-9395, by email at service@nzxt.com, or visit the NZXT Support site at nzxt.com/customer-support.

VII. HOW TO OBTAIN A WARRANTY SERVICE FROM NZXT

To receive a warranty service for your product when purchased directly from NZXT, you must submit a request via the NZXT Support site outlining the problem. If a technician deems the product defective or requiring testing, you will be required to provide a copy of your proof of purchase, which will enable you to submit a Return Merchandise Authorization "RMA" request.

Once approved, you`ll receive an RMA number, upon which you will be asked to ship the defective item back to NZXT with the RMA number clearly marked or labelled on the package. NZXT recommends that appropriate measures are taken to safeguard the product from damage during shipping.



VIII. APPLICABLE LAW AND ADDITIONAL LEGAL RIGHTS FOR CONSUMERS

This warranty gives you specific legal rights. These conditions are governed and construed in accordance with the laws of California (with exception of its conflict of law provisions), and the application of the United Nations Convention of Contracts for the International Sale of Goods is expressly excluded. The non-exclusive jurisdiction of the courts of California is agreed, which means that you may bring a claim to enforce your consumer protection rights in connection with this Global Warranty in the country which you have your habitual residence where you may have additional rights. These rights may vary.

For original consumers who are covered by consumer protection laws or regulations in their country, state, or province of purchase or, if different, their country, state, or province of residence, the benefits conferred by this warranty are in addition to all rights and remedies conveyed by such consumer protection laws and regulations. To the extent that liability under such consumer laws can be limited, NZXT's liability is limited, and its sole option, to repair or replacement, either new or refurbished, with a similar function that is equal or greater in value depending on supply.

In the United Kingdom:

- For NZXT products sold to customers in the UK, during the expected lifespan of your product your legal rights entitle you to the following:
 - > Up to 30 days: if your goods are faulty, then you can get an immediate refund.
 - > Up to six months: if your goods can't be repaired or replaced, then you're entitled to a full refund, in most cases.
 - > Up to six years: if your goods do not last a reasonable length of time you may be entitled to some money back.
- If the person seeking to rely on the guarantee is not the original consumer, the NZXT Warranty will cover the product in relation to that person provided that they are able to provide proof of the transfer of the benefit of the guarantee from the original consumer.
- The implied warranties under the Consumer Rights Act 2015 says that your goods must be as described, fit for all purposes for which such goods are usually supplied, and of satisfactory quality.

In the EU:

- If you are a consumer and have your habitual residence in the EU, you additionally enjoy the protection afforded to you by provisions that cannot be derogated from by agreement by virtue of the law where you have your habitual residence.



IX. WARRANTY SERVICE FROM RESELLERS

In the event that a warranty service is sought, you must provide proof of purchase (store receipt or invoice) in order to receive the service and if deemed necessary, repair or replacement product.

In North America:

Within the first 60 days after purchase, please return your product (or for power supplies installed within our enclosures, just the failed power supply) to your dealer or reseller for a replacement. If the product is still within warranty and you can no longer return it to your dealer, please contact NZXT Customer Support (see above) for assistance and instructions. NZXT will not accept returns without prior approval and an RMA number.

In Europe:

Within the first year after purchase, please return your product (or for power supplies installed within our enclosures, just the failed power supply) to your dealer or reseller for a replacement. If the product is still within warranty and you can no longer return it to your dealer, please contact NZXT Customer Support (see above) for assistance and instructions. NZXT will not accept returns without prior approval.

In Australasia:

Within the first two years after purchase, please return your product (or for power supplies installed within our enclosures, just the failed power supply) to your dealer or reseller for a replacement. If the product is still within warranty and you can no longer return it to your dealer, please contact NZXT Customer Support (see above) for assistance and instructions. NZXT will not accept returns without prior approval.

The cost of shipping will be borne at the first instance by you; however, if the purchased item is defective, NZXT will reimburse reasonable postage or transportation of costs.

Outside North America, Europe, and Australasia:

If your product needs to be returned within the warranty period, please contact the retailer or distributor from whom you purchased the product.



X. NZXT.COM STORE RETURNS/EXCHANGE POLICY

Eligible products under this NZXT Warranty qualify for a full refund or exchange only with an authorized RMA number and if the item is returned to the NZXT.com store inventory within 30 days of purchase. Returns are not allowed beyond 30 days of the purchase date. The NZXT.com Store reserves the right to deny any return or exchange. Refunds will be credited to the original method of payment. To initiate a return, simply submit a request via NZXT support site.

- > Visit nzxt.com/warranty and support.nzxt.com for information on warranty coverage and service.
- > Visite el sitio Web nzxt.com/warranty y support.nzxt.com para obtener información sobre la cobertura y el servicio de la garantía.
- > Visitez nzxt.com/warranty et support.nzxt.com pour les informations de la couverture de la garantie et du service.
- > Informationen zu Geltungsbereich und Service der Garantie finden Sie unter support.nzxt.com und nzxt.com/warranty.
- > Visitare il sito nzxt.com/warranty e support.nzxt.com per informazioni sulla copertura e sul servizio della garanzia.
- > Visite nzxt.com/warranty e support.nzxt.com para obter informações sobre a cobertura da garantia e assistência.
- > Подробную информацию об условиях гарантийного обслуживания см. на веб-сайте nzxt.com/warranty и support.nzxt.com.
- > 제품 보증 범위와 서비스 정보를 확인하시려면 nzxt.com/warranty 또는 support.nzxt.com 을 방문해 주시기 바랍니다.
- > 保証範囲およびサービスに関する情報については、support.nzxt.com と nzxt.com/warranty にアクセスしてください。
- > 请造访 nzxt.com/warranty 和 support.nzxt.com 了解保修范围和服务的信息。
- > 請訪問 nzxt.com/warranty 和 support.nzxt.com 了解產品保固範圍和更多服務訊息。

NZXT, Inc./ 15736 E Valley Blvd, City of Industry, CA 91744, USA
NZXT Europe GmbH/ Industriering Ost 66 | 47906 Kempen | Germany
+1 (800) 228-9395 / service@nzxt.com / [NZXT.com](https://nzxt.com)



SUPPORT AND SERVICE

If you have any questions or problems with the NZXT product you purchased, please don't hesitate to contact us using our support system. support.nzxt.com

Please include a detailed explanation of your problem and your proof of purchase. For comments and suggestions, you can e-mail our design team, designer@nzxt.com. Lastly we would like to thank you for your support by purchasing this product.

For more information about NZXT, please visit us online. NZXT Website: [NZXT.com](https://nzxt.com)

SOPORTE Y SERVICIO

Si tiene preguntas o problemas con el producto NZXT que usted compró, no dude en ponerse en contacto con service@nzxt.com y suministrar una explicación detallada de su problema así como su prueba de compra. Puede hacer consultas sobre piezas de repuesto en support.nzxt.com. Para comentarios y sugerencias, escriba un mensaje de correo electrónico a nuestro equipo de diseño: designer@nzxt.com. Gracias por comprar un producto NZXT. Para más información acerca de NZXT, visítenos en línea. Página web de NZXT: [NZXT.com](https://nzxt.com)

SUPPORT ET SERVICE

Si vous avez des questions ou des problèmes avec le produit NZXT que vous avez acheté, n'hésitez pas à contacter service@nzxt.com avec une description détaillée de votre problème et votre preuve d'achat. Vous pouvez aussi commander des pièces de remplacement auprès support.nzxt.com. Pour les commentaires et les suggestions, envoyez un email à notre équipe de design, designer@nzxt.com. Merci d'avoir acheté ce produit de NZXT. Pour plus d'informations sur NZXT, visitez notre site Web. Site Web de NZXT : [NZXT.com](https://nzxt.com)

KUNDENDIENST UND SERVICE

Falls Fragen oder Probleme bezüglich Ihres NZXT-Produktes auftreten, wenden Sie sich bitte mit einer detaillierten Problembeschreibung und Ihrem Kaufbeleg an service@nzxt.com.

Ersatzteile können Sie unter support.nzxt.com anfragen. Kommentare und Anregungen senden Sie bitte per designer@nzxt.com an unser Designteam. Vielen Dank, dass Sie ein NZXT-Produkt erworben haben. Weitere Informationen über NZXT erhalten Sie im Internet. NZXT-Webseite: [NZXT.com](https://nzxt.com)



ASSISTENZA E SERVIZIO

In caso di dubbi o problemi con il prodotto NZXT acquistato, non esitate a contattarci utilizzando il nostro sistema di assistenza.

support.nzxt.com

Includere una spiegazione dettagliata del problema e la prova di acquisto. Per commenti e suggerimenti, siete pregati di inviare un messaggio al nostro team di progettisti, all'indirizzo: designer@nzxt.com. Infine, vogliamo ringraziarvi del vostro supporto con l'acquisto di questo prodotto. Per altre informazioni su NZXT, visitate il nostro sito. Sito NZXT: NZXT.com

ASSISTÊNCIA E MANUTENÇÃO

Caso tenha questões ou problemas com o produto NZXT adquirido, não hesite em contactar-nos através do endereço service@nzxt.com fornecendo a explicação detalhada do seu problema e a prova de compra. Poderá solicitar peças de substituição através do endereço support.nzxt.com. Para comentários e sugestões, contacte a nossa equipa de design através do endereço de e-mail, designer@nzxt.com. Obrigado por ter adquirido um produto NZXT. Para mais informações

acerca da NZXT, visite-nos online. Web site da NZXT: NZXT.com

СЛУЖБА ПОДДЕРЖКИ И ОБСЛУЖИВАНИЯ

В случае возникновения вопросов или неисправностей в приобретенных вами продуктах NZXT обращайтесь по адресу: service@nzxt.com с подробным описанием проблемы и подтверждением покупки. О наличии запчастей можно узнать, обратившись по адресу: support.nzxt.com. Замечания и предложения отправляйте в адрес нашей группы разработчиков: designer@nzxt.com. Благодарим вас за покупку продукта NZXT. Более подробная информация о компании NZXT представлена на наших веб-сайтах. Веб-сайт NZXT: NZXT.com



지원 및 서비스

구입한 NZXT 제품과 관련하여 질문 또는 문제가 있을 경우, 당사의 지원 시스템 (support.nzxt.com)을 사용하여 문의하십시오.

문제를 자세히 기술하고 구매 증빙을 제출하십시오. 의견 또는 제안 사항이 있을 경우 당사 설계 팀에 designer@nzxt.com으로 이메일을 보내십시오. 마지막으로 이 제품을 구입하여 당사를 응원해 주셔서 감사합니다. NZXT에 대해 자세히 알려면 온라인으로 방문하십시오. NZXT 웹사이트: NZXT.com

サポートおよびサービス

購入されましたNZXTの製品に関するご質問または問題は、問題の詳細および購入の証明を添えて、ご遠慮なくservice@nzxt.comまでご連絡ください。交換部品はsupport.nzxt.comまでお尋ねください。ご意見およびご提案は弊社設計チーム、designer@nzxt.comまでメールを送信してください。NZXT製品をご購入いただきましてありがとうございます。NZXTに関する詳細は、インターネット上のウェブサイトをご覧ください。NZXT ウェブサイト: NZXT.com

支持和服务

如果有任何疑问或者在使用 NZXT 产品的过程中遇到任何问题,欢迎联络 service@nzxt.com,联络时请提供关于问题的详细说明及购买凭证。您可以向 support.nzxt.com 查询更换部件。如有任何意见或建议,欢迎致信我们的设计团队,电子邮件地址是 designer@nzxt.com。感谢您购买 NZXT 产品。有关 NZXT 的更多信息,请造访我们的在线网站。NZXT 网站: NZXT.com

支援和服務

如果在使用NZXT 產品的過程中有遇到任何問題或疑問，歡迎聯繫 service@nzxt.com，並請提供問題的詳細敘述及購買證明。您可以透過 support.nzxt.com 查詢更換部件。如有任何意見或建議，歡迎來信與設計團隊聯繫 designer@nzxt.com。最後，感謝您購買 NZXT 產品。有關 NZXT 的更多信息，請訪問我們的網站。NZXT 網站: NZXT.com



CE CONFORMITY

This device complies with the requirements set out in the Council Directive on the Approximation of the Laws of the Member States relating to Electromagnetic Compatibility (2014/30/EU), Low-voltage Directive (2014/35/EU), ErP Directive (2009/125/EC) and RoHS directive (2011/65/EU). This product has been tested and found to comply with the harmonized standards for Information Technology Equipment published under Directives of the Official Journal of the European Union.

FCC COMPLIANCE STATEMENT

This device complies with Part 15 of the FCC Rules, Subpart B, Unintentional Radiators.

Operation is subject to the following two conditions: (1) This device may not cause harmful interference, and (2) this device must accept any interference received, including interference that may cause undesired operation.

CANADIAN DEPARTMENT OF COMMUNICATIONS

STATEMENT

This digital apparatus does not exceed the Class B limits for radio noise emissions from digital apparatus set out in the Radio Interference Regulations of the Canadian Department of Communications. This class B digital apparatus complies with Canadian ICES-003.

Avis de conformité à la réglementation d'Industrie Canada Cet appareil numérique de la classe B est conforme à la norme NMB-003 du Canada.

WEEE STATEMENT

Under the European Union (“EU”) Directive on Waste Electrical and Electronic Equipment, Directive 2012/19/EU, products of “electrical and electronic equipment ” cannot be discarded as municipal waste anymore and manufacturers of covered electronic equipment will be obligated to take back such products at the end of their useful life.

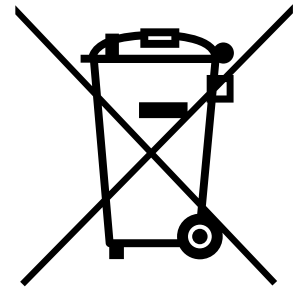

EUROPEAN UNION

Batteries, battery packs, and accumulators should not be disposed of as unsorted household waste. Please use the public collection system to return, recycle, or treat them in compliance with the local regulations.

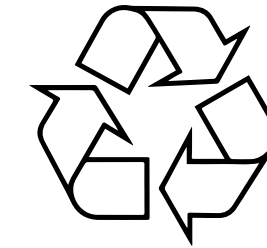

CALIFORNIA, USA

The button cell battery may contain perchlorate material and requires special handling when recycled or disposed of in California. For further information please visit: <http://www.dtsc.ca.gov/hazardouswaste/perchlorate>

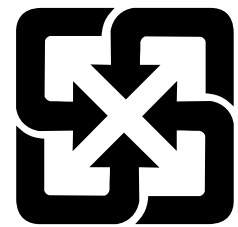

TAIWAN

For better environmental protection, waste batteries should be collected separately for recycling or special disposal.

CAUTION

- There is a risk of explosion, if battery is incorrectly replaced. Replace with the same or equivalent type recommended by the manufacturer.

6.8 WEEE (WASTE ELECTRICAL AND ELECTRONIC EQUIPMENT) STATEMENT

CANVAS 25F



ENGLISH

To protect the global environment and as an environmentalist, NZXT must remind you that...

Under the European ("EU") Directive on Waste Electrical and Electronic Equipment, Directive 2012/19/EU, effective February 14, 2014, products of "electrical and electronic equipment" cannot be discarded as municipal wastes, and manufacturers of covered electronics must take back such products at the end of their useful life. NZXT will comply with the product take back requirements at the end-of-life of NZXT products that are sold within the EU. You can return these products to local collection points.

ESPAÑOL

NZXT como empresa comprometida con la protección del medio ambiente, recomienda:

Bajo la directiva 2012/19/EU de la Unión Europea en materia de desechos y/o equipos electrónicos, con fecha de rigor desde el 14 de febrero de 2014, los productos clasificados como "eléctricos y equipos electrónicos" no pueden ser depositados en los contenedores habituales de su municipio, los fabricantes de equipos electrónicos, están obligados a hacerse cargo de dichos productos al término de su período de vida. NZXT estará comprometido con los términos de recogida de sus productos vendidos en la Unión Europea al final de su periodo de vida. Usted debe depositar estos productos en el punto limpio establecido por el ayuntamiento de su localidad o entregar a una empresa autorizada para la recogida de estos residuos.



FRANÇAIS

En tant qu'écologiste et afin de protéger l'environnement, NZXT tient à rappeler ceci...

Au sujet de la directive européenne (EU) relative aux déchets des équipement électriques et électroniques, directive 2012/19/EU, prenant effet le 14 février 2014, que les produits électriques et électroniques ne peuvent être déposés dans les décharges ou tout simplement mis à la poubelle. Les fabricants de ces équipements seront obligés de récupérer certains produits en fin de vie. NZXT prendra en compte cette exigence relative au retour des produits en fin de vie au sein de la communauté européenne. Par conséquent vous pouvez retourner localement ces matériels dans les points de collecte.

DEUTSCH

Hinweis von NZXT zur Erhaltung und Schutz unserer Umwelt
Gemäß der Richtlinie 2012/19/EU über Elektro- und Elektronik-Altgeräte dürfen Elektro- und Elektronik-Altgeräte nicht mehr als kommunale Abfälle entsorgt werden. NZXT hat europaweit verschiedene Sammel- und Recyclingunternehmen beauftragt, die in die Europäische Union in Verkehr gebrachten Produkte, am Ende seines Lebenszyklus zurückzunehmen. Bitte entsorgen Sie dieses Produkt zum gegebenen Zeitpunkt ausschliesslich an einer lokalen Altgerätesammelstelle in Ihrer Nähe.

ITALIANO

Per salvaguardare l'ambiente globale, NZXT ricorda che:
La Direttiva Europea (UE) RAEE, in materia di rifiuti costituiti da apparecchiature elettriche ed elettroniche (Direttiva 2012/19/UE, in vigore dal 14 febbraio 2014), le apparecchiature elettriche ed elettroniche non possono essere smaltite tra i rifiuti municipali e i produttori di apparecchiature elettroniche sono tenuti a ritirare tali prodotti alla fine del ciclo di vita utile. NZXT è conforme ai requisiti inerenti al ritiro a fine vita dei prodotti NZXT venduti nell'UE. Questi prodotti devono essere conferiti nei centri di raccolta locali.



PORTUGUÊS

Para proteger o meio ambiente global e como um ambientalista, a NZXT lembra você de que...

Sob a Diretiva Europeia (“EU”) sobre Equipamentos Eletroeletrônicos Residuais, Diretiva 2012/19/EU, em vigor desde 14 de fevereiro de 2014, produtos de “equipamentos eletroeletrônicos” não podem ser descartados como lixo municipal e os fabricantes de eletrônicos cobertos devem receber de volta tais produtos no fim de sua vida útil. A NZXT cumprirá os requisitos de recolhimento do produto ao fim da vida útil dos produtos da NZXT vendidos dentro da UE. Você pode devolver esses produtos aos pontos de coleta locais.

РУССКИЙ

В целях поддержки движения защитников окружающей среды и охраны глобальной окружающей среды компания NZXT напоминает вам...

В соответствии с требованиями Директивы по утилизации электрического и электронного оборудования ЕС 2012/19/EU от 14 февраля 2014 г. продукты, являющиеся «электрическим и электронным оборудованием», должны утилизироваться отдельно от бытовых отходов, и производители оборудования, подпадающего под действие данной директивы, должны принимать такие продукты в случае их возврата в конце срока службы. NZXT будет соблюдать требования к возврату продукта производителю в конце срока службы продуктов NZXT, которые продаются на территории ЕС. Для возврата продуктов производителю созданы специализированные пункты приема.



한국어

지구를 보호하고, 환경에 친화적인 기업인 NZXT는 다음 사항을 안내합니다. 2014년 2월 14일부터 시행되는 Directive 2012/19/EU, 폐전기·전자제품에 관한 유럽연합("EU")의 지침에 따라 "전기·전자제품"은 일반폐기물로서 폐기할 수 없으며, 수명이 다한 제품은 반드시 해당 제품의 제조업체가 회수해야 합니다. NZXT는 유럽 내에서 판매되는 NZXT 제품에 대한 회수 지침을 준수합니다. 수명이 다한 제품은 해당 지역의 회수처에 반납하실 수 있습니다.

日本語

NZXTはかけがえのない地球環境を保護するために、廃電気・電子製品(WEEE)に関する欧州連合(EU)の指令を遵守します。WEEE指令2012/19/EU(2014年2月14日発効)で定められた通り、EU域内では電気機器・電子機器製品は地方自治体の廃棄物として廃棄できないため、対象となる電子機器メーカーは、製品が耐用年数に達した際に該当製品を引き取る必要があります。NZXTは、EU内で販売されるNZXT製品の耐用年数終了時の製品引き取り要件を遵守します。ユーザーの方におかれましては、該当製品を最寄りの回収場所にお出しいただけますよう、お願いいたします。

简体中文

作为一家环保型企业，为保护全球环境，NZXT 提醒您..... 根据 2014 年 2 月 14 日生效的欧洲 ("EU") 废弃电子电气设备指令——第 2012/19/EU 号指令的规定，“电气和电子设备”产品不可作为市政废物丢弃，相关电子产品的制造商须在此类产品使用寿命结束时将其收回。对于 NZXT 在欧盟地区售出的 NZXT 产品报废时，NZXT 将遵循该产品回收要求。您可以将这些产品送至当地的回收点。

中文

為保護全球環境，NZXT 提醒您... 依據 2014 年 2 月 14 日生效的歐盟 ("EU") 廢棄電子電氣設備指令第 2012/19 / EU 號指令規定，「電氣和電子設備」產品不得視為都市廢棄物丟棄，相關的電子產品製造商必須在產品使用壽命結束時將產品回收。對於歐盟境內銷售的 NZXT 產品，NZXT 將在產品使用壽命結束時，按照產品回收要求收回產品。您可以將這些產品送到當地的回收點。

6.9 REVISION HISTORY

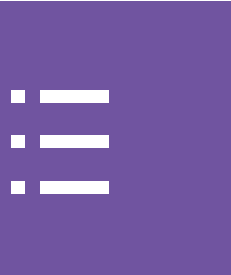

Version 1.2, 2022/11/10