

NZXT

N7 B550

ATX MOTHERBOARD

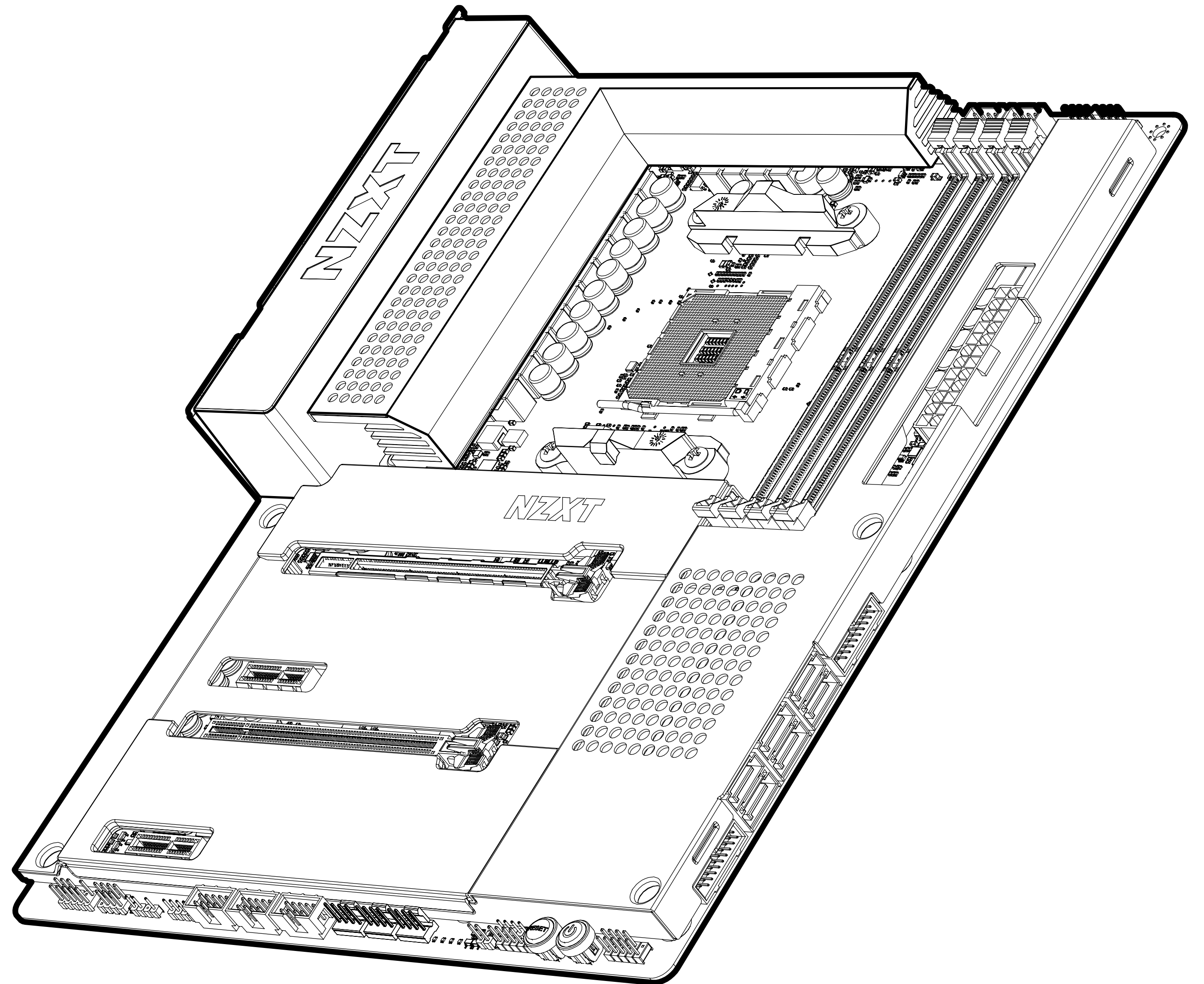

TABLE OF CONTENTS

VERSION 1.1

1. PREFACE..... 02

2. PRODUCT INFORMATION..... 03

3. COMPONENTS & PORTS..... 10-12

4. DOWNLOADING NZXT CAM..... 42

5. APPENDIX..... A-1



A. Copyright© NZXT, Inc. All Rights Reserved.

This manual including all illustrations and screen captures, is protected under international copyright laws, with all rights reserved. Neither this manual, nor any of the material contained herein, may be reproduced without written consent of the author.

B. Disclaimer

The information in this document is subject to change without notice. The manufacturer makes no representations or warranties with respect to the contents hereof and specifically disclaims any implied warranties of merchantability or fitness for any particular purpose. The manufacturer reserves the right to revise this publication and to make changes from time to time in the content hereof without obligation of the manufacturer to notify any person of such revision or changes.

C. Trademark Recognition

Product names used in this manual are the properties of their respective owners and are acknowledged.

D. Safety Precaution

Follow these safety precautions when installing the motherboard:

- It is recommended to wear a grounding strap attached to a grounded device to avoid damage from static electricity.
- Discharge static electricity by touching the metal case of a safely grounded object before working on the motherboard.
- Leave components in the static-proof bags.
- Always remove the AC power by unplugging the power cord from the power outlet before installing or removing the motherboard or other hardware components.

2. PRODUCT INFORMATION



2.1 Package Contents 04

2.2 Specifications 05

2.1 PACKAGE CONTENTS

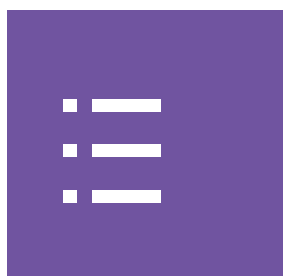

A. N7 B550 Motherboard

x1

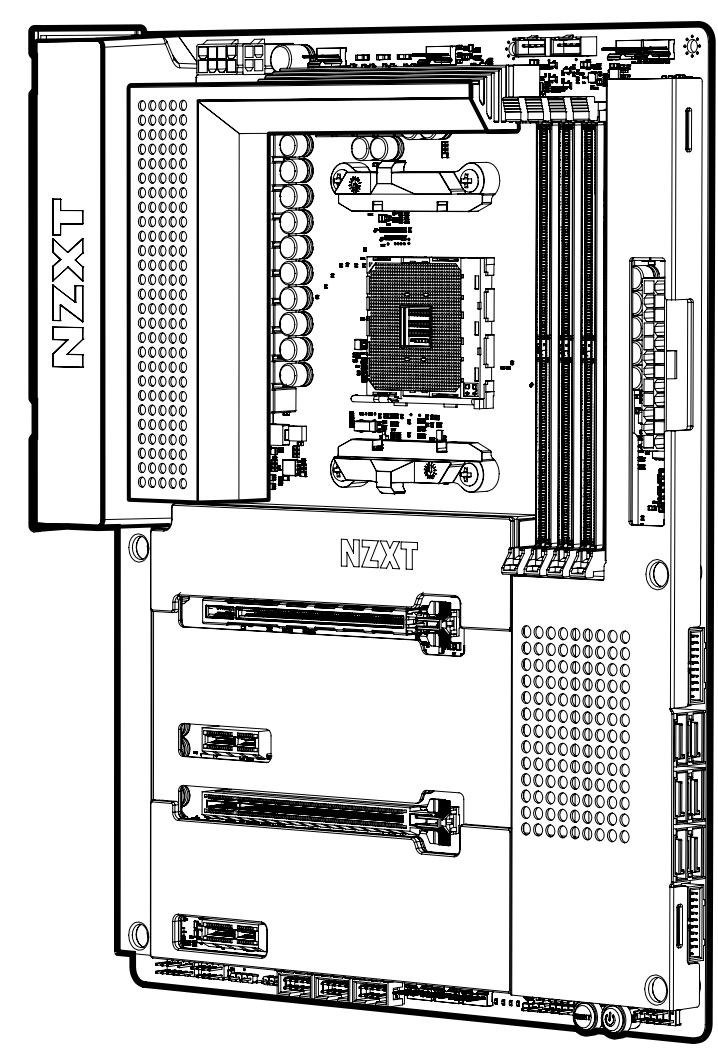

B. SATA Cables

90°x2, 180°x2

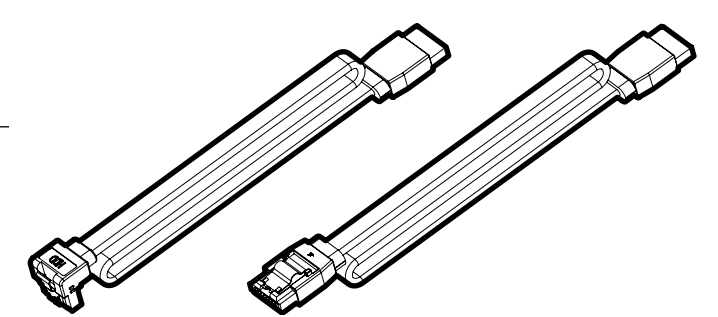

C. M.2 Screws

x2

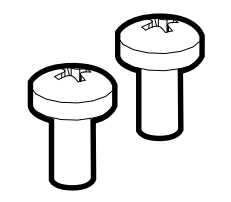

D. Wireless Antenna

x2

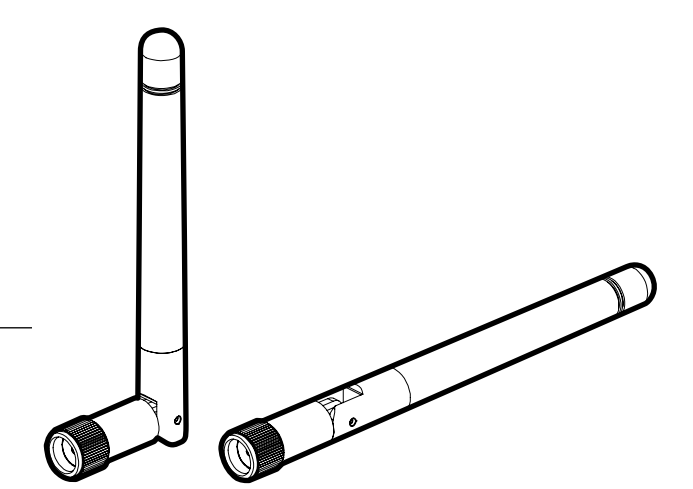



CPU & Socket

Supports AMD Socket AM4 Ryzen™ Processors (3000, 4000, and 5000 Series Processors) *

* Not compatible with AMD Ryzen™ 5 3400G and Ryzen™ 3200G

Chipset

AMD® B550

Memory

4 * DIMM, Max. 128GB, DDR4

Dual-channel memory architecture

- AMD Ryzen series CPUs (Vermeer)
support DDR4 4666+(O.C.)/ 4600(O.C.)/ 4533(O.C.) /4466(O.C.)/ 4400(O.C.)/ 4333(O.C.)/ 4266(O.C.)/ 4200(O.C.)/ 4133(O.C.)/ 4000(O.C.)/ 3866(O.C.)/ 3800(O.C.)/ 3733(O.C.)/ 3600(O.C.)/ 3466(O.C.)/ 3200/ 2933/ 2667/ 2400/ 2133ECC & non-ECC, un-buffered memory*
- AMD Ryzen series CPUs (Matisse)
support DDR4 4666+(O.C.)/ 4600(O.C.)/ 4533(O.C.) /4466(O.C.)/ 4400(O.C.)/ 4333(O.C.)/ 4266(O.C.)/ 4200(O.C.)/ 4133(O.C.)/ 4000(O.C.)/ 3866(O.C.)/ 3800(O.C.)/ 3733(O.C.)/ 3600(O.C.)/ 3466(O.C.)/ 3200/ 2933/ 2667/ 2400/ 2133 ECC & non-ECC, un-buffered memory*
- AMD Ryzen series APUs (Renoir)
support DDR4 4733+(O.C.)/ 4666(O.C.)/ 4600(O.C.)/ 4533(O.C.) /4466(O.C.)/ 4400(O.C.)/ 4333(O.C.)/ 4266(O.C.)/ 4200(O.C.)/ 4133(O.C.)/ 4000(O.C.)/ 3866(O.C.)/ 3800(O.C.)/ 3733(O.C.)/ 3600(O.C.)/ 3466(O.C.)/ 3200/ 2933/ 2667/ 2400/ 2133 ECC & non-ECC, un-buffered memory*
- Support Extreme Memory Profile (XMP) memory module
- 15µ Gold Contact in DIMM Slots

*Please refer to Memory QVL on NZXT's website (www.nzxt.com) for more information.



Expansion Slots

- AMD Ryzen Series CPUs (Vermeer)
2 * PCIe x16 Slots (PCIe1: 4.0 x16 mode; PCIe3: 3.0 x4 mode)
- AMD Ryzen Series CPUs (Matisse)
2 * PCIe x16 Slots (PCIe1: 4.0 x16 mode; PCIe3: 3.0 x4 mode)
- AMD Ryzen Series CPUs (Renoir)
2 * PCIe x16 Slots (PCIe1: 3.0 x16 mode; PCIe3: 3.0 x4 mode)
 - Supports AMD Quad CrossFireX™ and CrossFireX™
 - Supports NVMe SSD as boot disks2 * PCIe 3.0 x1 Slots
1 * M.2 Socket (Key E), supports type 2230 WiFi/BT module

Integrated Graphics

Integrated AMD Radeon™ Vega Series Graphics in Ryzen Series APU*

** Actual support may vary by CPU*

- DirectX 12, Pixel Shader 5.0
- Shared memory default 2GB. Max Shared memory supports up to 16GB with 32GB system memory installed.
- Supports HDMI 2.1 with max. resolution up to 4K x 2K (4096x2160) @ 60Hz, HDR and HDCP 2.3
- Supports Microsoft PlayReady®

Multi-GPU Support

Supports AMD 2-Way CrossFireX™ Technology



Storage

AMD® B550 Chipset

- 1 * M2_1: M.2 type 2242/2260/2280 (PCIe 4.0 x4 mode (with Mastisse & Vermeer) or PCIe 3.0 x4 (with Renoir))
- 1 * M2_2: M.2 type 2242/2260/2280 (PCIe 3.0 x2 & SATA mode)
- 6 * SATA 6Gb/s ports*
Support RAID 0/1/5/10, NCQ, AHCI and Hot Plug

* M2_2 and SATA3_5_6 share lanes.

LAN

Realtek® RTL8125BG 2.5G LAN

- Support Wake-On-LAN
- Supports Energy Efficient Ethernet 802.3az

Wireless

Intel Dual Band Wireless-AX210 Wi-Fi 6E

Wi-Fi 802.11 a/b/g/n/ax

- Support dual band frequency 2.4/5GHz/6GHz
- Support MU-MIMO

USB Ports

- 3 * USB 3.2 Gen 2 ports (3 at back panel)
- 1 * USB 3.2 Gen 2 Type-C (at back panel)
- 1 * USB 3.2 Gen 2 front panel port (For USB Type-C)
- 8 * USB 3.2 Gen 1 ports (4 at back panel, 4 at mid-board)
- 8 * USB 2.0 ports (2 at back panel, 6 at mid-board)



Bluetooth

Bluetooth V5.2

Audio

Realtek® ALC1220 Codec

- 8-Channel High Definition Audio, 32-bit /192KHz DAC
- 120dB SNR DAC with Differential Amplifier
- NE5532 Premium Headset Amplifier for Front Panel Audio Connector (Supports up to 600 Ohm impedance headsets)
- Nichicon Fine Gold Series Audio Capacitors
- 15μ Gold Audio Connector and Gold Audio Jacks

Rear I/O

- 2 * USB 2.0 ports
- 3 * USB 3.2 Gen 2 ports
- 1 * USB 3.2 Gen 2 Type-C port
- 4 * USB 3.2 Gen 1 ports
- 1 * HDMI™ port
- 2 * Wireless antenna SMA connectors
- 1 * Clear CMOS button
- 1 * BIOS Flashback button
- 1 * LAN (RJ45) port
- 1 * Optical S/PDIF Out port
- 1 * 5.1-Channel audio jacks¹



Internal I/O

- 1 * 24-pin ATX power connector
- 1 * 8+4-pin ATX 12V power connector
- 1 * 4-pin CPU_FAN connector(1)
- 1 * 4-pin AIO_PUMP connector(2)
- 5 * 4-pin SYS_FAN connectors(2)
- 2 * NZXT RGB LED connectors(3)
- 1 * 5V ARGB LED connector(4)
- 1 * 12V RGB LED connector(5)
- 3 * USB 2.0 header (Up to 6 USB 2.0 ports)
- 2 * USB 3.2 Gen1 header (Up to 4 USB 3.2 Gen 1 ports)
- 1 * USB 3.2 Gen2 front panel header (For USB Type-C)
- 6 * SATA 6Gb/s connectors
- 1 * M.2 Socket 3 with M Key, type 2242/2260/2280 storage device support (PCIe 4.0 x4 mode (with Mastisse & Vermeer) or PCIe 3.0 x4 (with Renoir))
- 1 * M.2 Socket 3 with M Key, type 2242/2260/2280 storage device support (PCIe 3.0 x2 & SATA mode)
- 1 * M.2 Socket 1 with E Key, (For wireless cards)
- 1 * Front panel audio connector
- 1 * Power button
- 1 * Reset button
- 4 * POST LEDs

1. CPU_Fan connector supports 3-pin or 4-pin fans with maximum 2A (24W) fan power.
2. AIO_PUMP and all SYS_FAN connectors support maximum 2A (24W) per fan header and auto detects if a 3-pin or 4-pin fan is connected.
3. Supports up to 40 individually addressable LEDs per channel. 80 LEDs total. Lighting channels support up to six addressable RGB LED Strips or five Aer RGB Fans.
4. Supports in total up to 5V/3A, 15W LED Strip. Supports up to 40 individually addressable LEDs.
5. Supports in total up to 12V/3A, 36W LED Stripconnected.

Operating System

Microsoft® Windows® 10 (64-bit)

Form Factor

ATX

Certification

FCC, CE, KCC, BSMI, ErP/EuP Ready

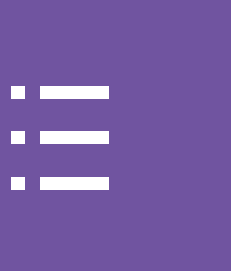

3.1 Covers 13

3.2 Exploded View 14

3.3 Ports Overview 15

3.4 Rear I/O 16

3.5 CPU Socket 17

3.6 DIMM Slots 19

3.7 PCI Express Expansion Slots 21

3.8 SATA Connectors 23

3.9 M.2 Slots for Storage 24

3.10 M.2 Slot for Wireless Connectivity 26

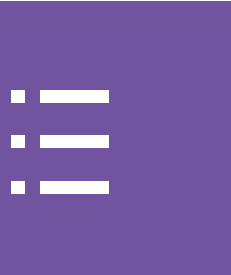

3.11 Antenna..... 27

3.12 Power Connectors..... 28

3.13 USB Connectors..... 29

3.14 Front Panel Audio Connector 30

3.15 Front Panel Connector..... 31

3.16 Fan Connectors..... 32

3.17 NZXT RGB Connectors..... 33

3.18 5V Addressable RGB Connector 34

3.19 12V RGB Connector 35

3.20 Buttons and Post Leds..... 36

3. COMPONENTS & PORTS



3.21 CMOS Battery.....39

3.22 BIOS Flashback.....40

3.1 COVERS



The all-metal N7 cover pieces can be removed by hand. They are latched onto the motherboard through multiple points. When installing and removing, please pay close attention to these points and apply an even force to prevent damage.

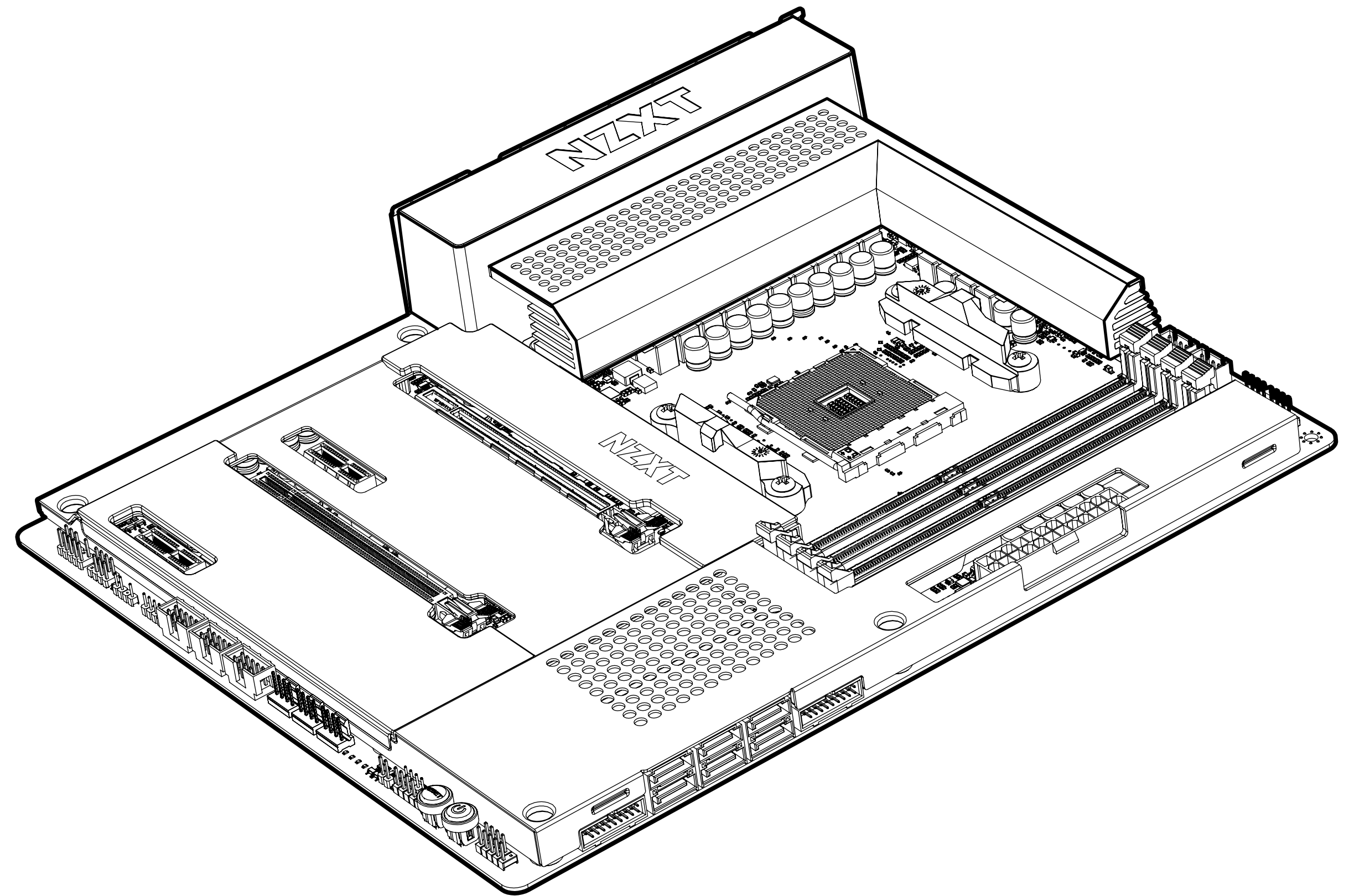

3.2 EXPLODED VIEW

N7 B550 ATX MOTHERBOARD

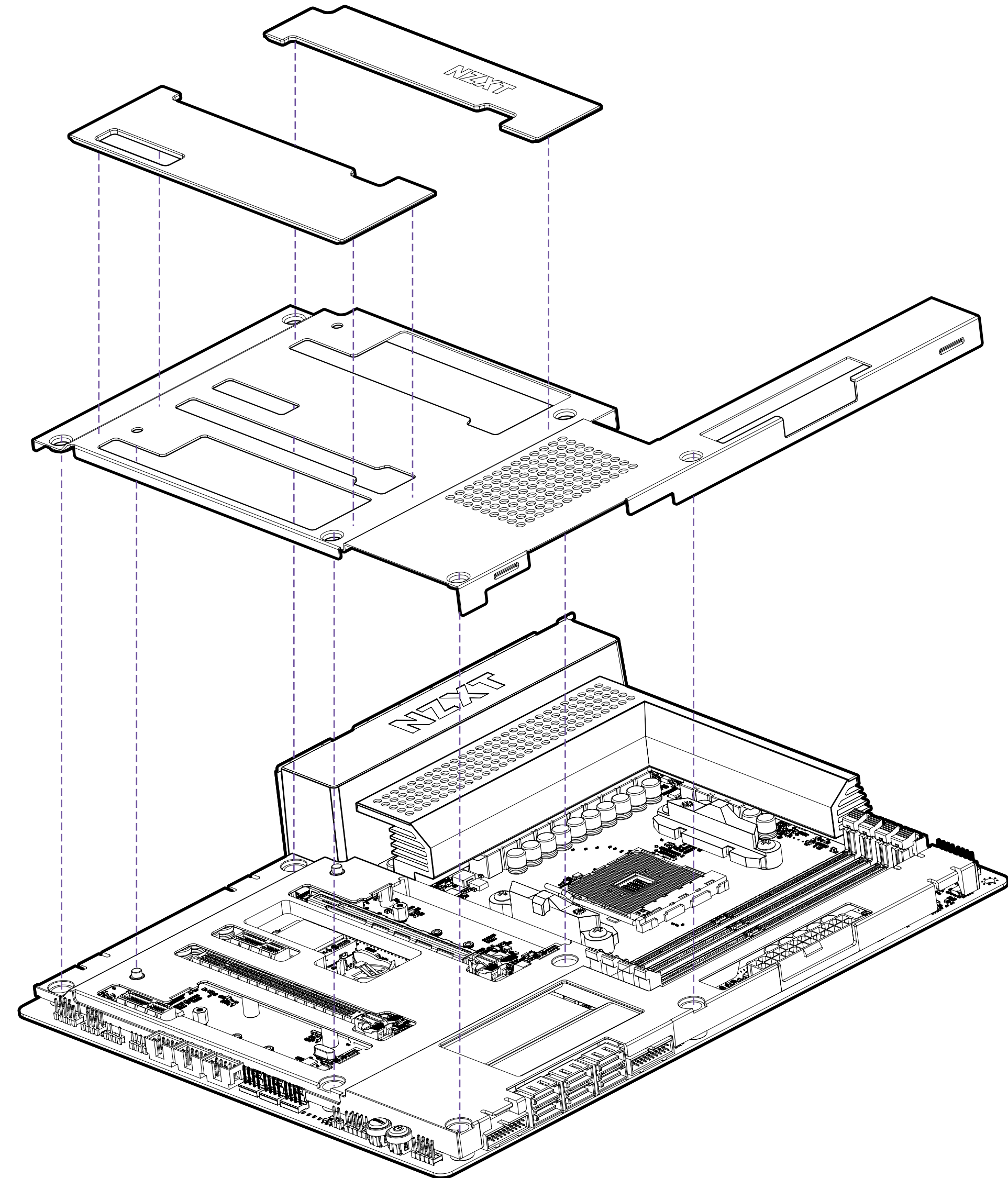

3.3 PORTS OVERVIEW

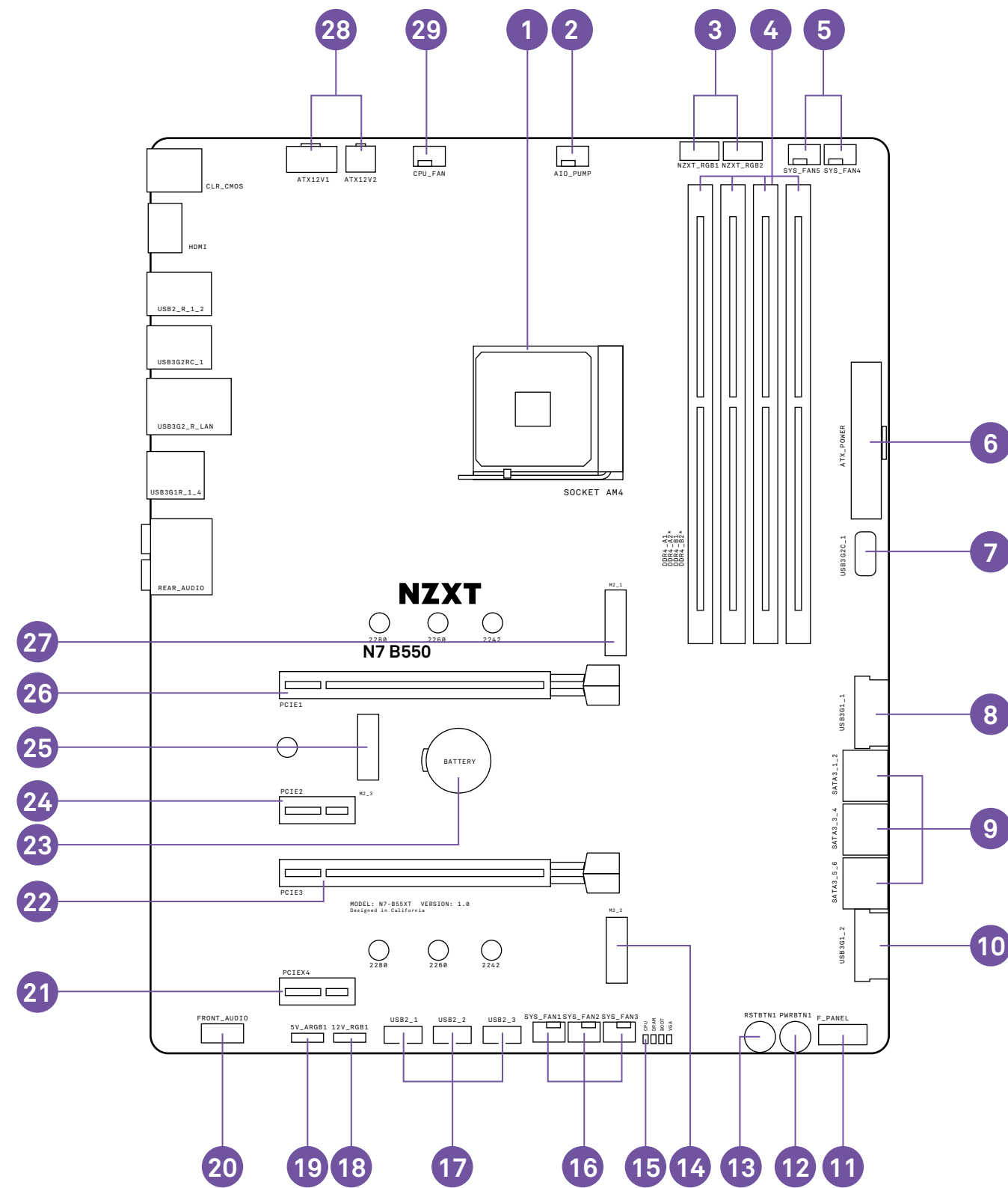

NO.	PORT NAME	DESCRIPTION
1	CPU Socket	AM4 Socket for AMD Ryzen processors (3000, 4000, and 5000 Series Processors)
2	AIO_PUMP	4-pin AIO pump connector
3	NZXT RGB 1 & 2	4-pin LED header
4	DIMM A1-B2	288-pin DDR4 memory slots
5	SYS_FAN 4-5	4-pin fan connectors
6	ATX_POWER	24-pin ATX power connector
7	USB3G2C_1	Front panel USB 3.2 Gen 2 Type-C header
8	USB3G1_1	Front panel USB 3.2 Gen 1 header
9	SATA 1-6	Serial ATA 6Gbps connectors
10	USB3G1_2	Front panel USB 3.2 Gen 1 header
11	Front Panel Connectors	Front panel switches and LED connectors
12	Power Button	Power Button
13	Reset Button	Reset Button
14	M2_2	M.2 Socket 3 with M key, supports type 2242/2140/2280 storage devices (Supports PCIE & SATA mode)
15	POST LEDs	Boot status indicator

NO.	PORT NAME	DESCRIPTION
16	SYS_FAN 1-3	4-pin fan connectors
17	USB2_1-3	Front panel USB 2.0 headers
18	12V RGB1	4-pin 12V LED header
19	5V ARGB1	3-pin 5V LED header
20	FRONT_AUDIO	Front panel audio connector
21	PCIE4	PCI Express x1 Gen3 slot
22	PCIE3	PCI Express x16 Gen3 slot for GPU
23	Battery	CMOS Battery
24	PCIE4	PCI Express x1 Gen3 slot
25	M2_3	M.2 Socket 1 with E key, supports type 2230 wireless devices
26	PCIEX16_1	PCI Express x16 Gen3 slot for GPU
27	M2_1	M.2 Socket 3 with M key, supports type 2242/2260/2280 storage devices (Supports PCIE)
28	ATX_12V	8+4-pin +12V power connector
29	CPU_FAN	4-pin CPU fan connector

3.4 REAR I/O

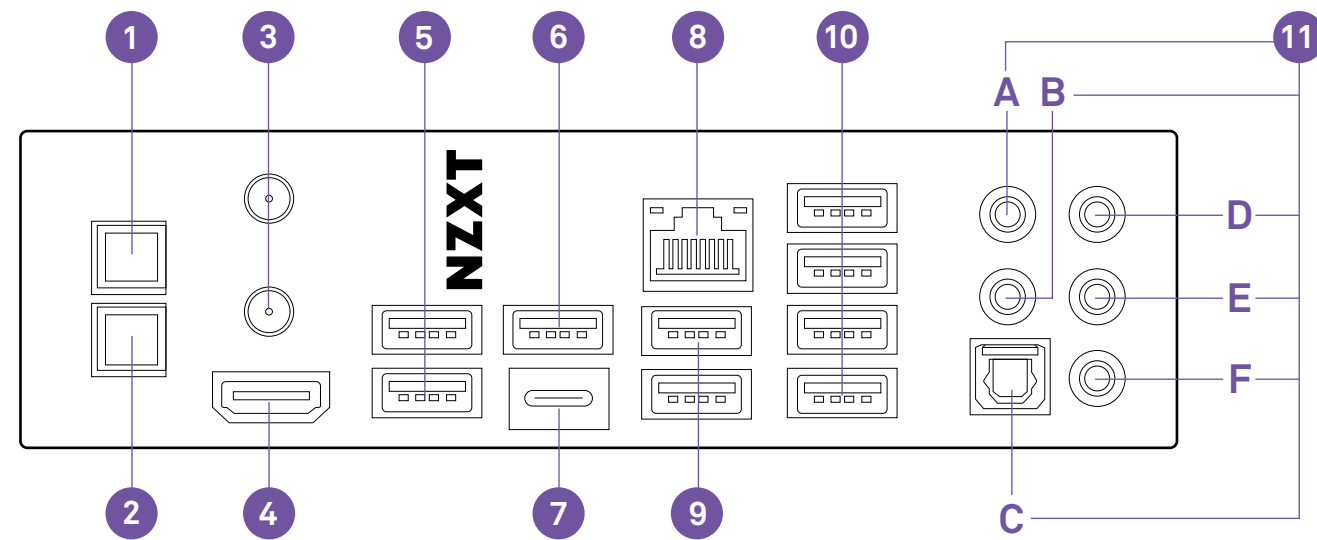

NO.	PORT NAME
1	BIOS Flashback Button
2	Clear CMOS Button
3	Wireless Antenna
4	HDMI port
5	USB 2.0 x 2
6	USB 3.2 Gen 2
7	USB 3.2 Gen 2 Type-C

NO.	PORT NAME
8	RJ45 LAN port
9	USB 3.2 Gen 2 x 2
10	USB 3.2 Gen 1 x 4
11	Audio ports
	A. Center and Subwoofer
	B. Rear Surround
	C. Optical SPDIF Out port
	D. Line-in
	E. Front Left and Right
	F. Microphone

3.5 CPU SOCKET

The AM4 socket has a triangle to assist in correctly lining up the CPU for placement within the socket.

NOTE

- Always unplug the power cord from the power outlet before installing or removing the CPU.
- Confirm that the CPU heatsink has been mounted properly before booting.
- Please refer to the CPU cooler manufacturer's instructions to install your cooler.

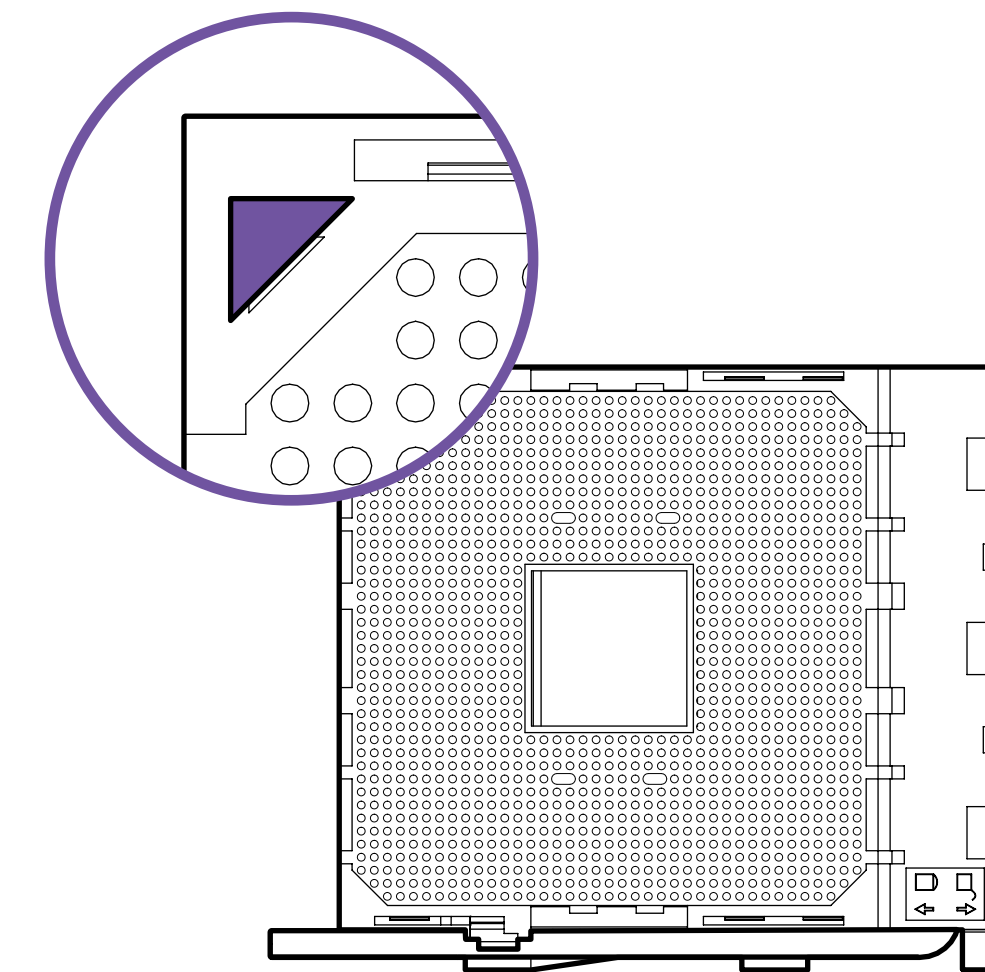
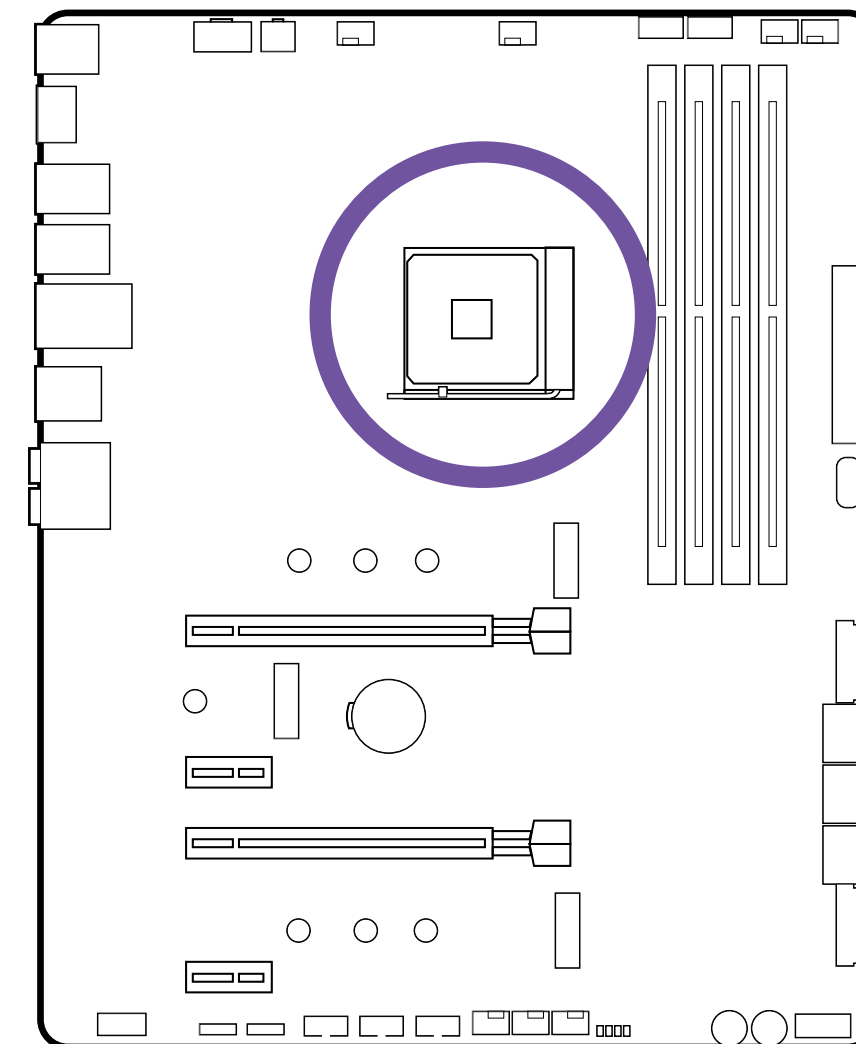

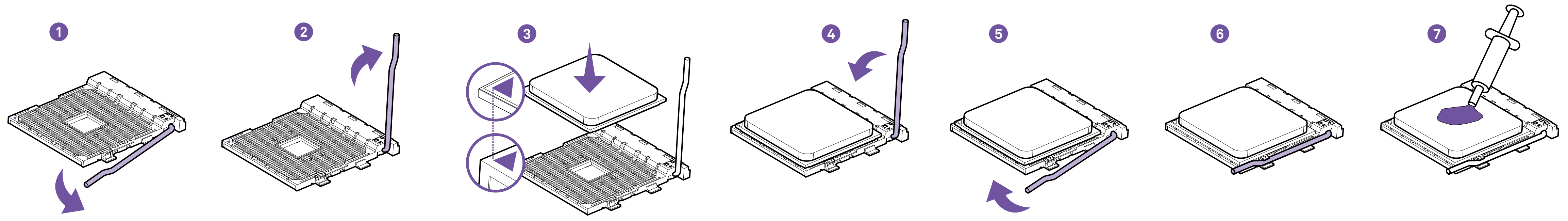

- Push down on the retention arm and outwards to release.
- Place the CPU, making sure the triangle on the CPU matches the corner as indicated.
- Push down on the retention arm to lock it into place.
- Apply thermal paste as needed and install your CPU cooler.

3.6 DIMM SLOTS

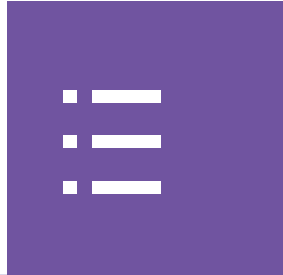

The DIMM slots are located here. Please see the diagram for recommended memory configuration.

NOTE

- Insert memory modules in the A2 slot first.

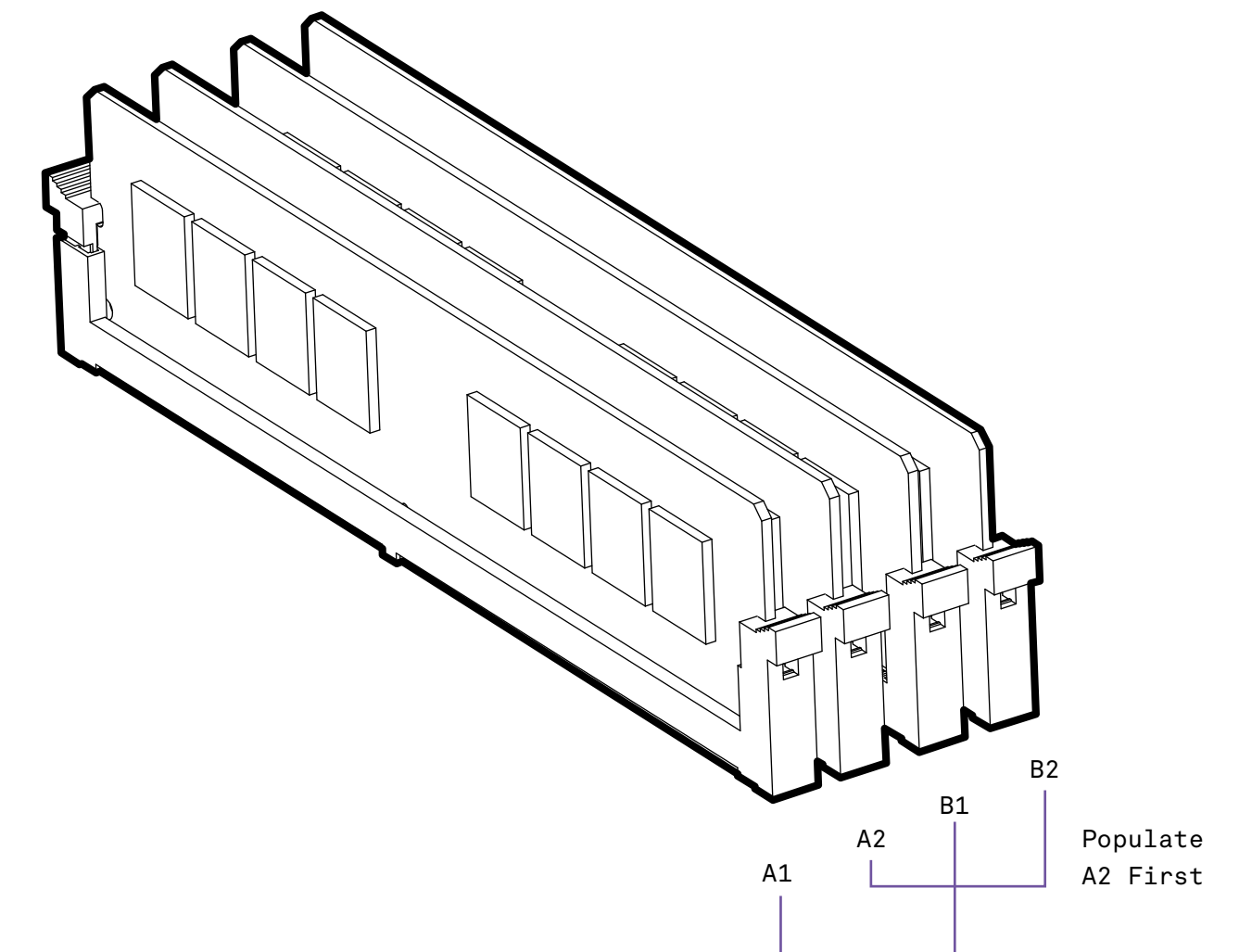
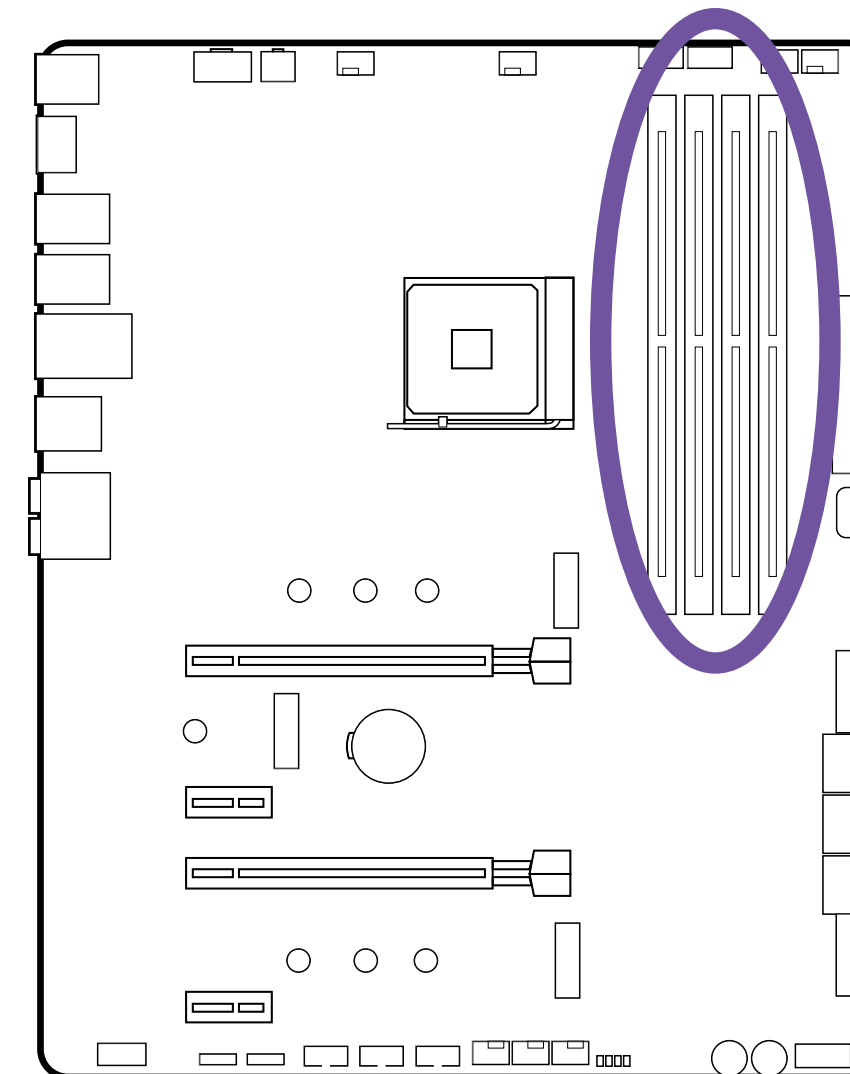

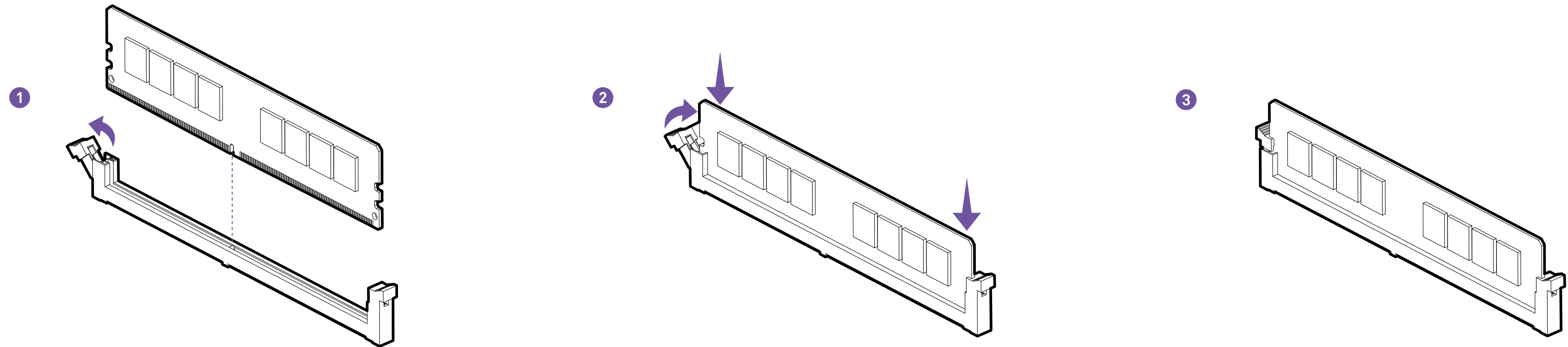

- Push the release lever as indicated.
- Match the memory with the middle notch and align into the DIMM slots.
- Push the memory into the DIMM slot firmly until the lever has been locked automatically.

3.7 PCI EXPRESS EXPANSION SLOTS



See the diagram below for the list of slots.
Please install graphics cards using the PCIE1
first then the PCIE3.

NOTE

- For a single PCIe x16, please use PCIE1.
- When adding or removing expansion cards, always turn off the power supply and unplug the power supply power cable from the power outlet. Read the expansion card's documentation to check for any necessary additional hardware or software changes.

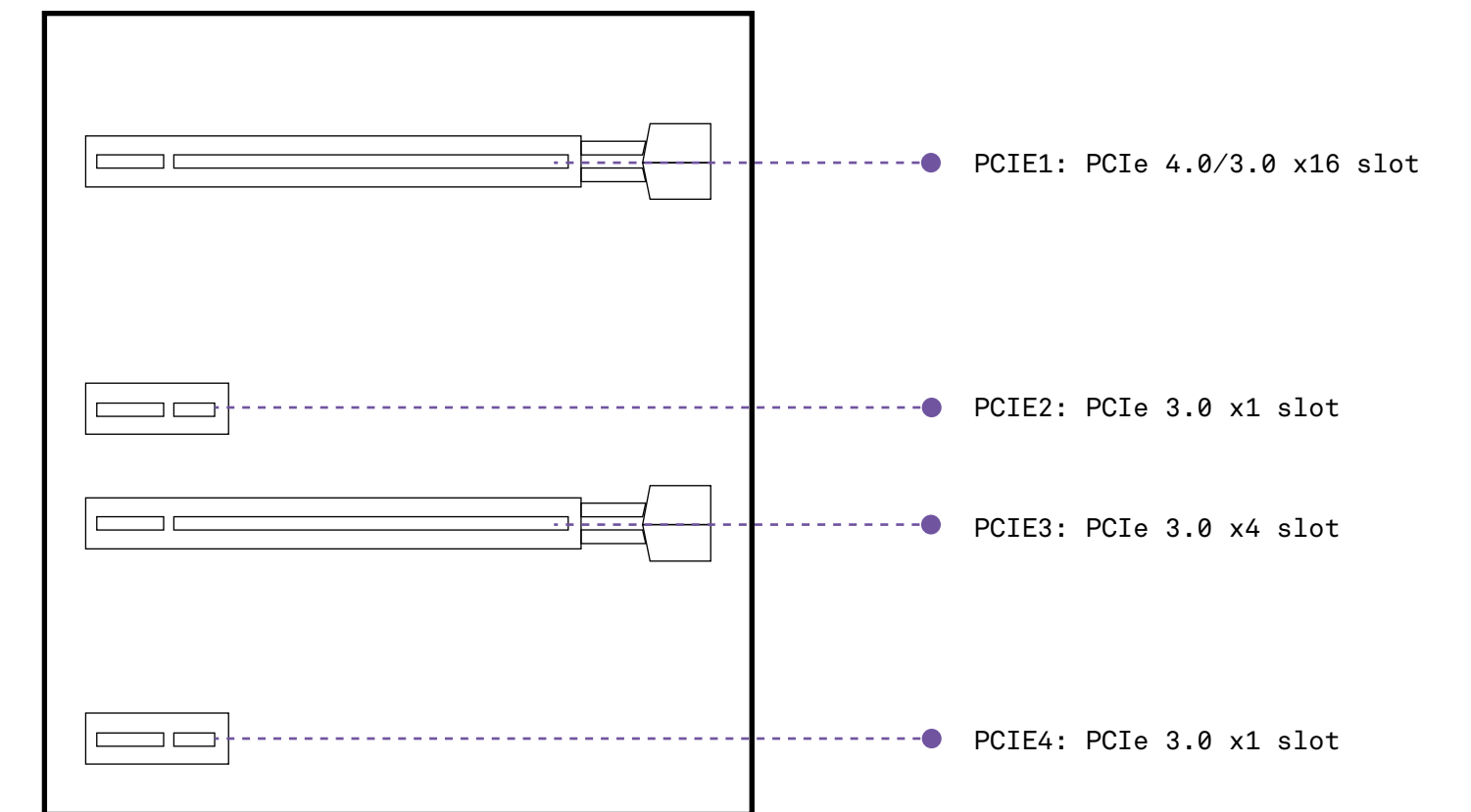
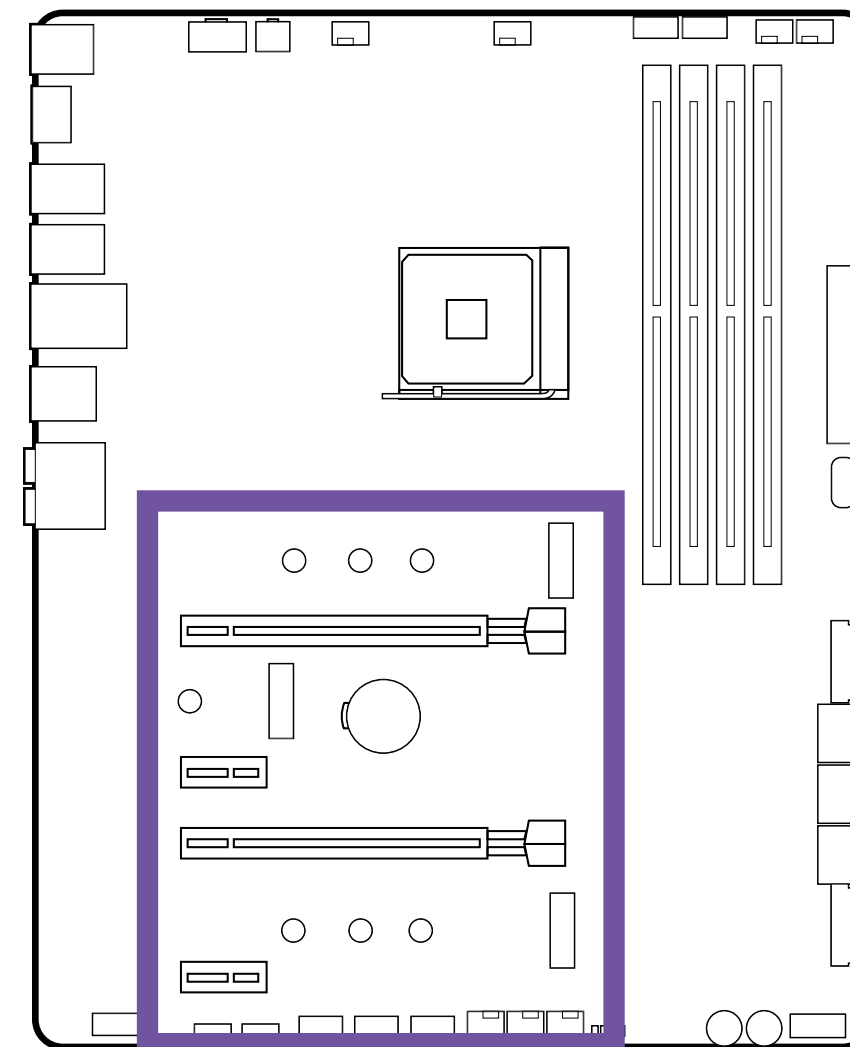



For power supply recommendations for multi-GPU configurations, please refer to the user guide of your graphics card to make sure you meet all the system requirements.

To install multiple graphics cards :

- Turn off your computer and disconnect the power cord, install two graphics cards into the PCIE1 and PCIE3 slots.
- Connect all PCIe power connectors of the graphics cards.
- Reconnect the power cord, power up the computer and install the drivers and software included in your graphics card package.

3.8 SATA CONNECTORS

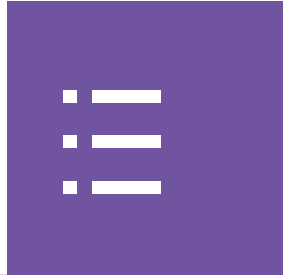

These connectors are SATA 6Gb/s interface ports. Each connector can connect to one SATA device.

⚠ NOTE

- M2_2 and SATA3_5_6 share lanes.
- Please do not fold the SATA cable at a 90-degree angle. Data loss may result during transmission otherwise.
- SATA cables have identical plugs on either side of the cable. However, it is recommended that the flat connector be connected to the motherboard for space saving purposes.

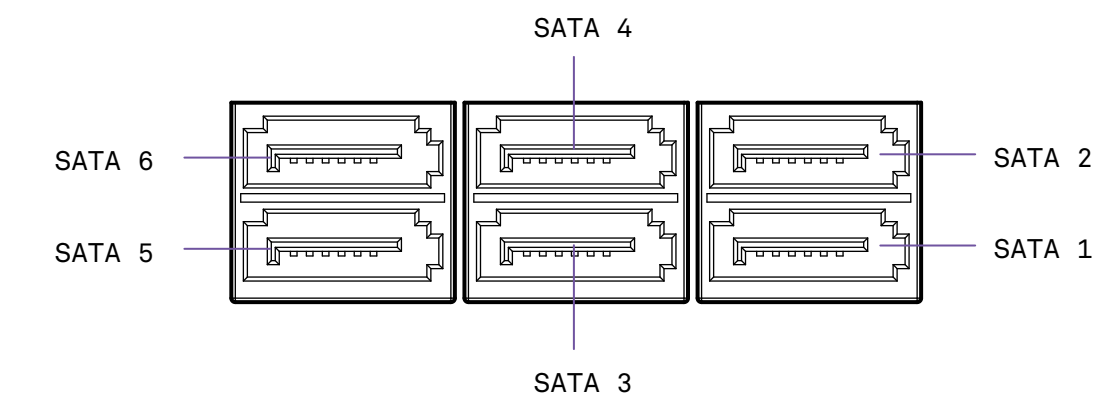
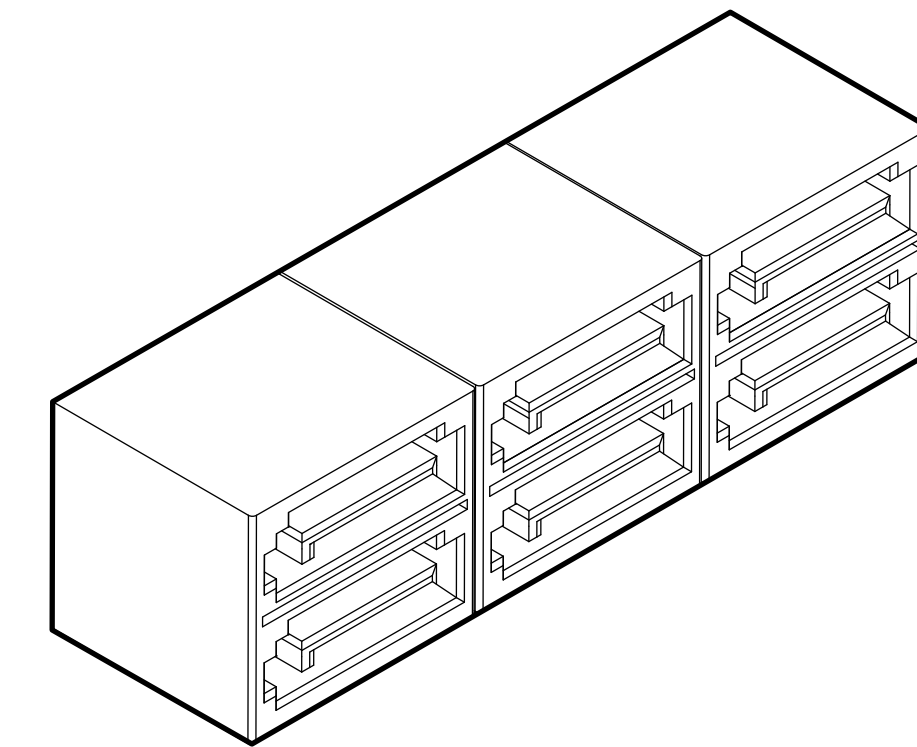
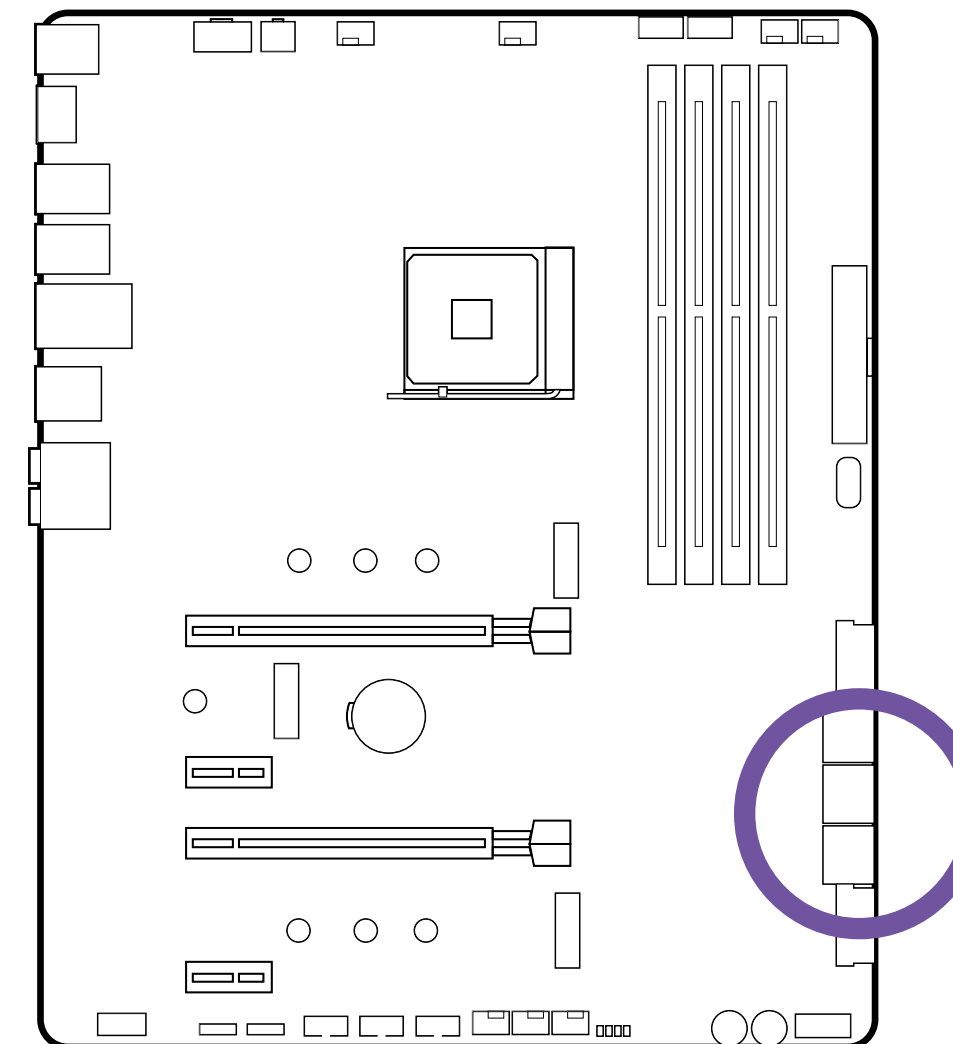

3.9 M.2 SLOTS FOR STORAGE



There are two M.2 slots on the N7 motherboard. You will need to remove the steel cover pieces prior to installation. The M.2 slots supports form factors up to type 2280.

NOTE

- If you have installed an M.2 drive, we recommend leaving the cover off to ensure optimal cooling for your M.2 drives.

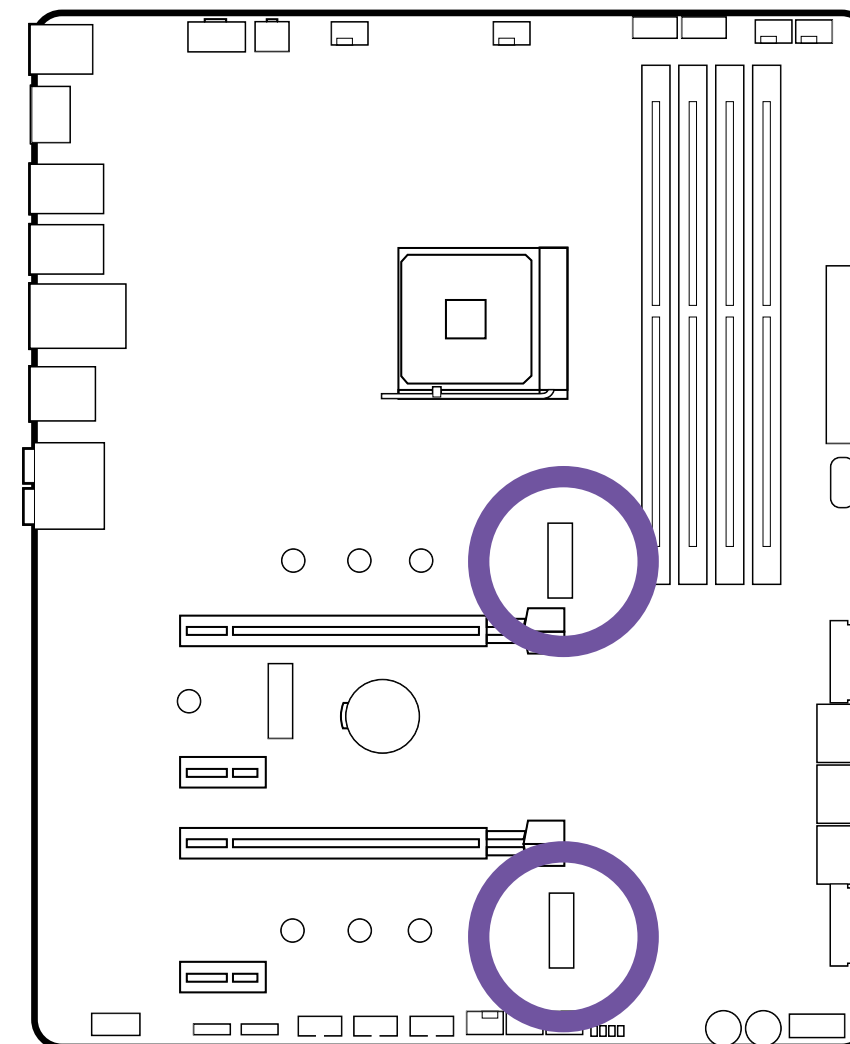

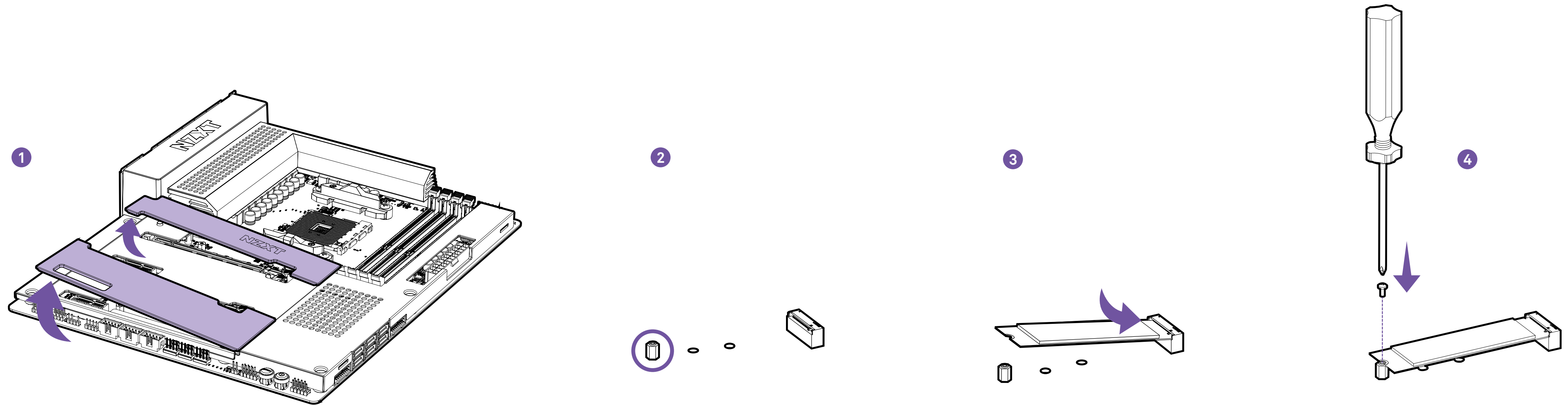

- Remove the M.2 slot cover.
- Confirm the standoff is at the required position and if necessary, move the standoff.
- Insert your M.2 drive into the M.2 slot at an angle.
- Secure the M.2 drive using the M.2 screw onto the standoff and tighten.

3.10 M.2 SLOT FOR WIRELESS CONNECTIVITY

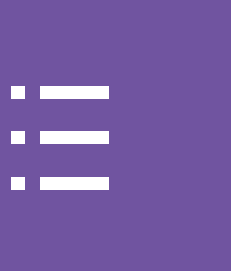

A Key E M.2 slot supporting PCIe is located at the center of the motherboard. This slot is prepopulated with an Intel® Wireless-AX210 and two antenna cables route the wireless signals to the rear I/O.

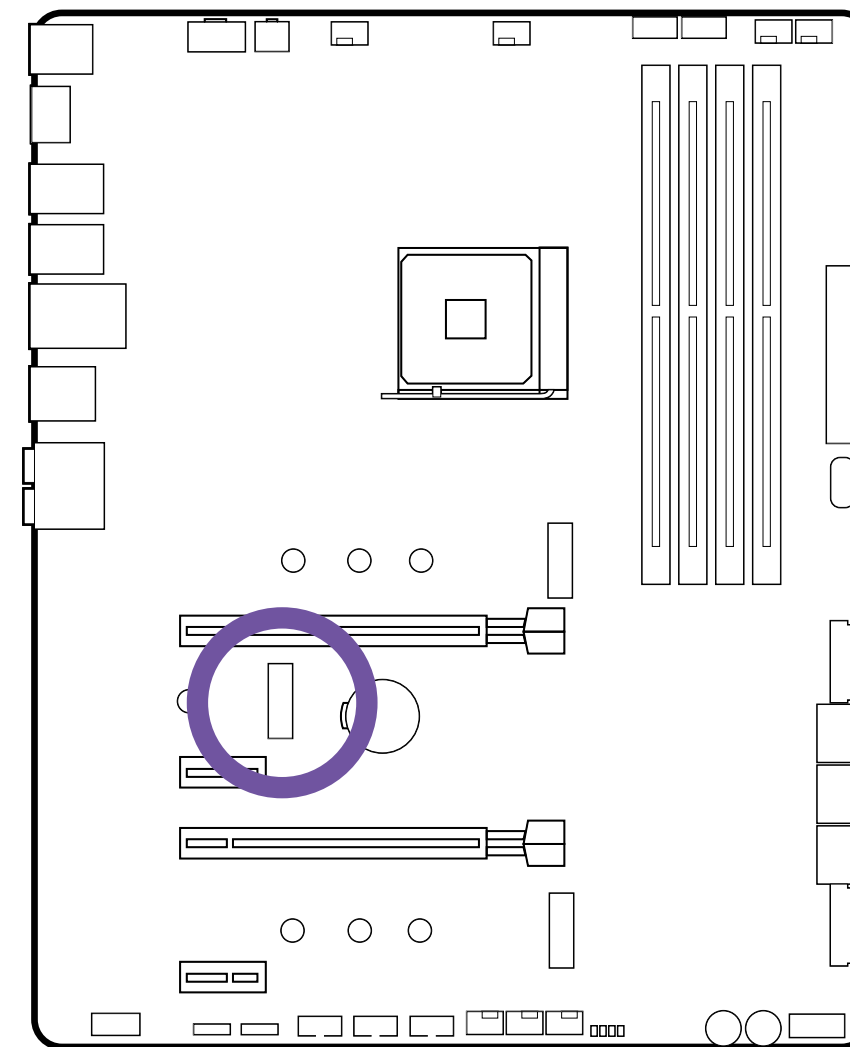

3.11 ANTENNA

Wireless antennas are included to boost the wireless and Bluetooth signals.

- Attach the antenna onto the rear I/O by securing them directly to the SMA ports labelled “Wi-Fi”.

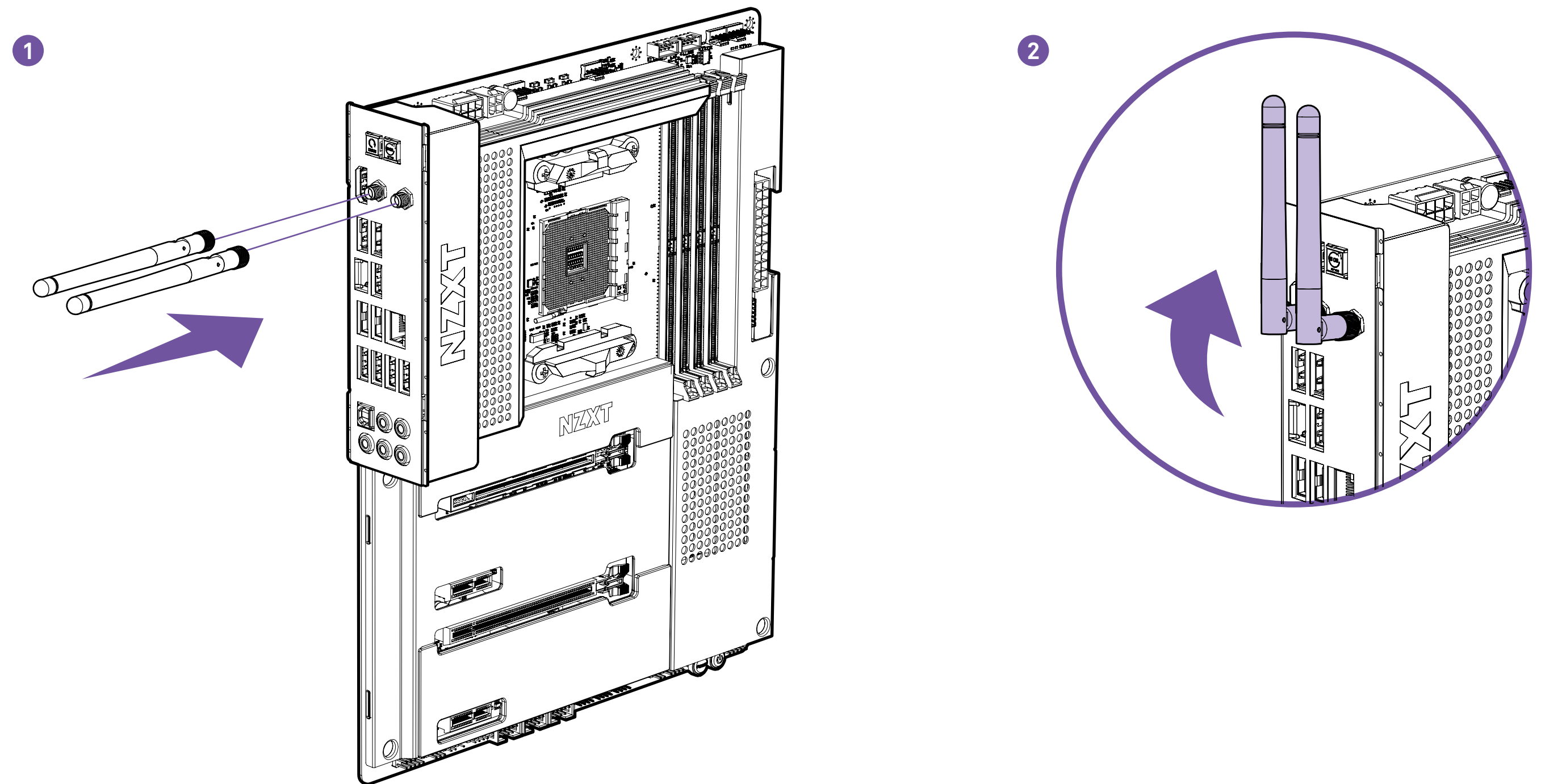

3.12 POWER CONNECTORS

These connectors connect to an ATX power supply.

NOTE

- Make sure that all the power cables are securely connected to a proper ATX power supply to ensure stable operation of the motherboard.

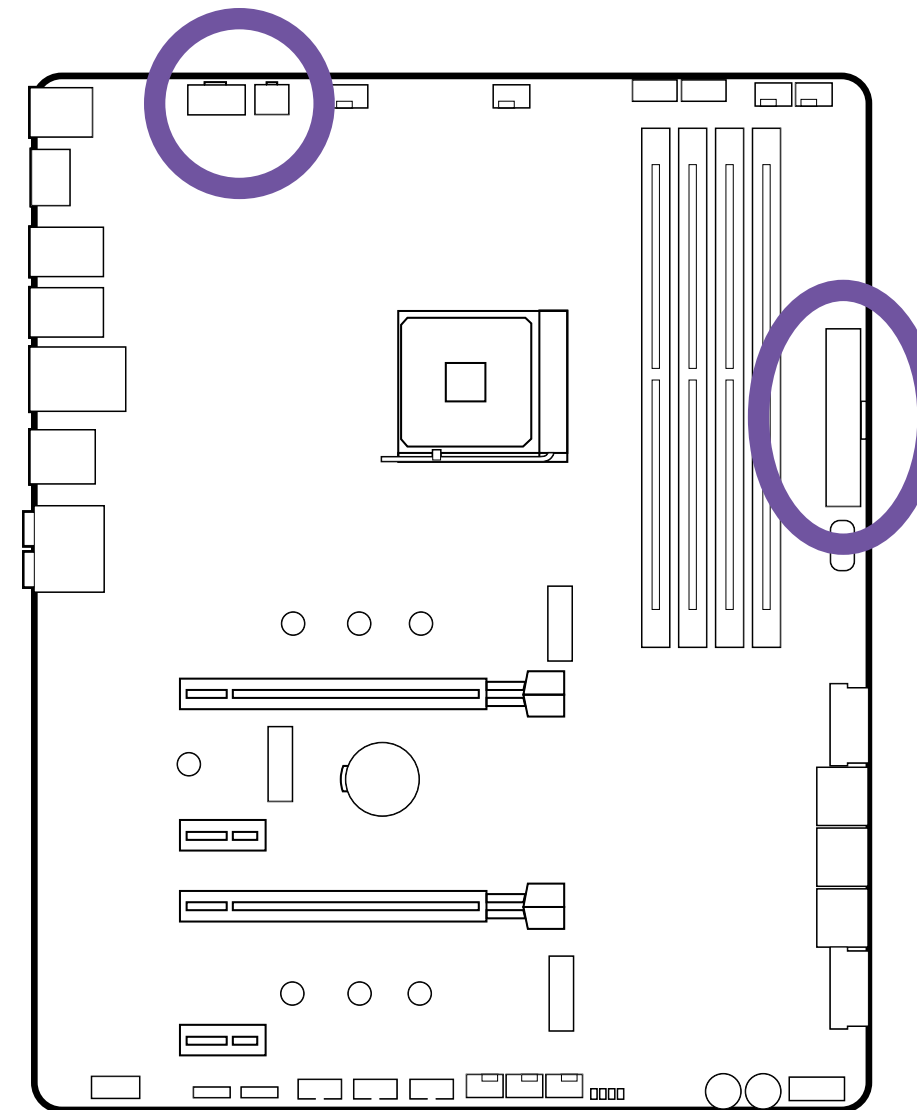

8+4-pin ATX_{12V}

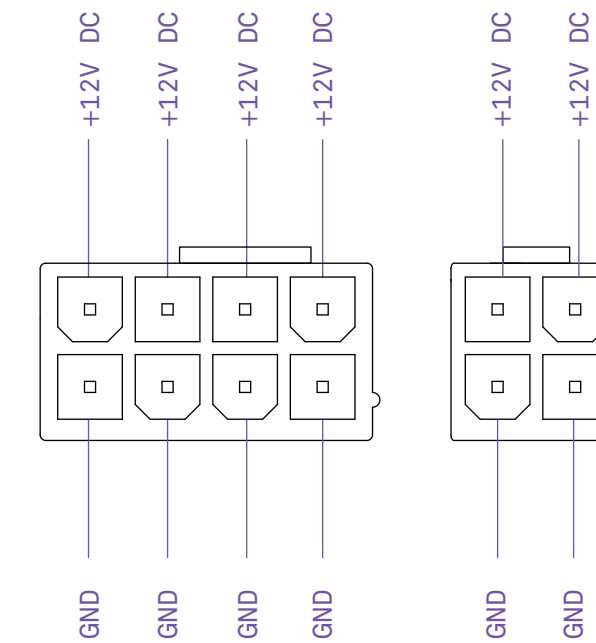

24-pin ATX_{POWER}

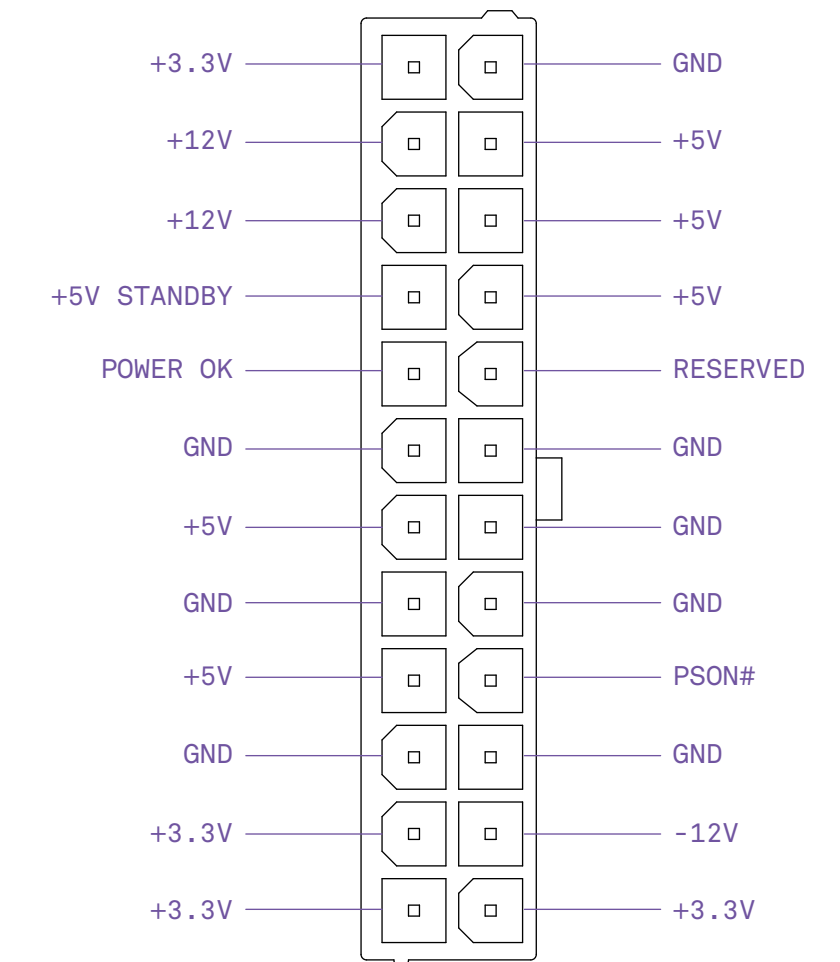

3.13 USB CONNECTORS

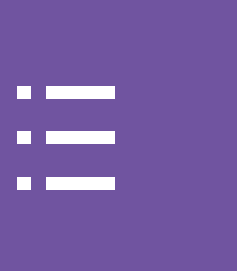

These connectors allow you to connect to the front panel USB ports or devices requiring internal USB ports.

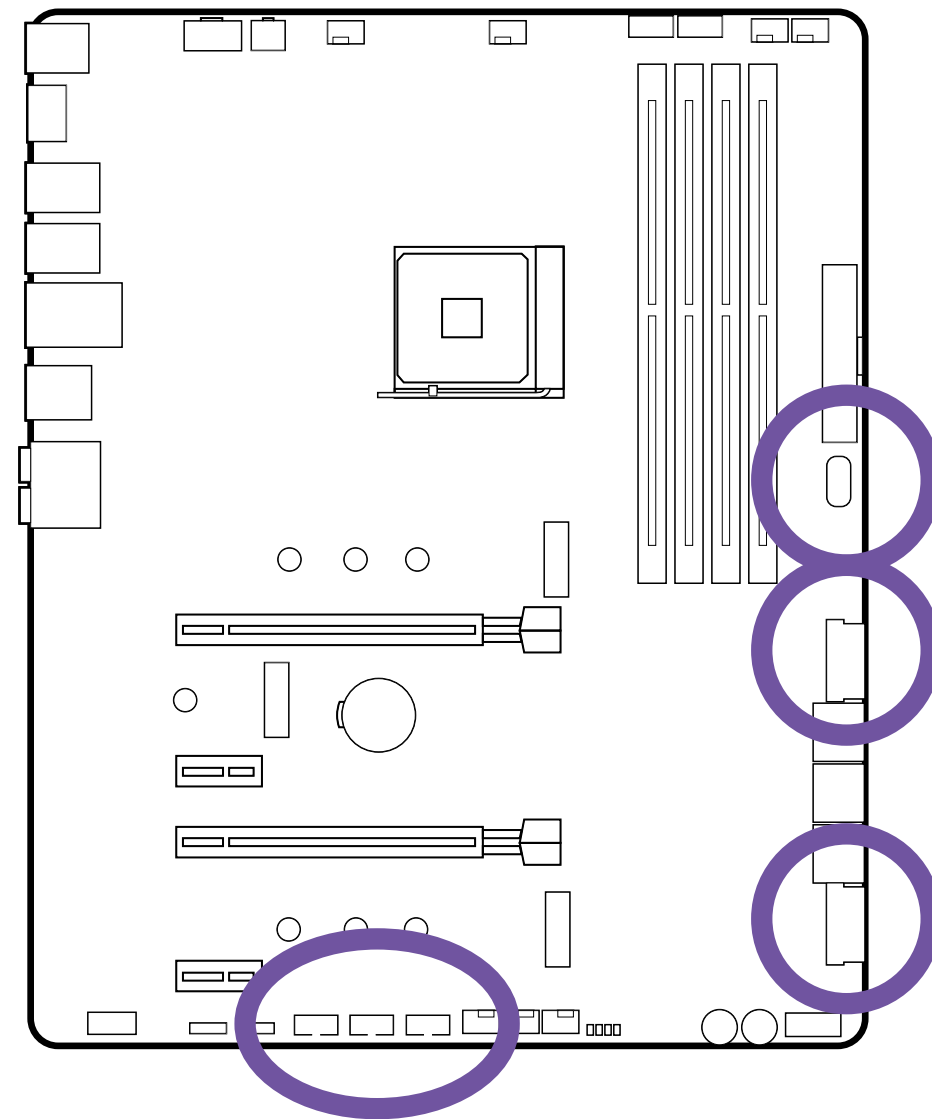

USB 2.0

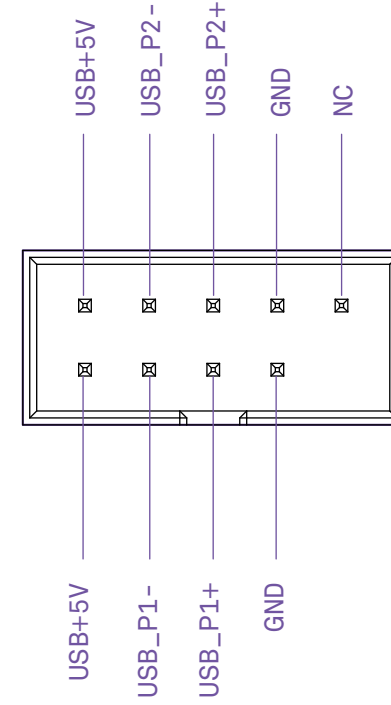

USB 3.2 Gen.1

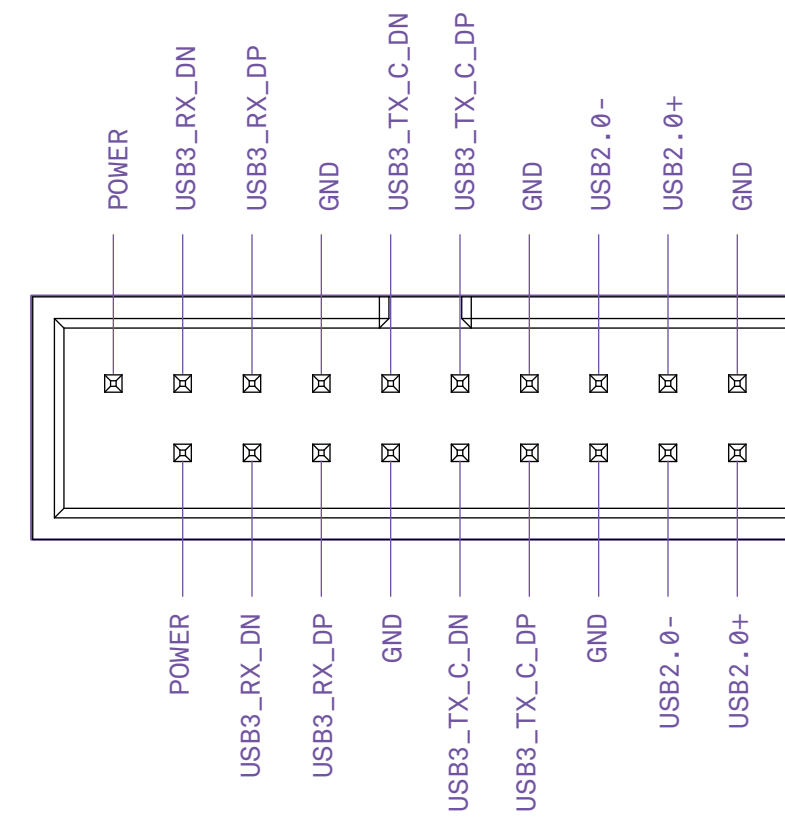

USB 3.2 Gen.2 Type-C

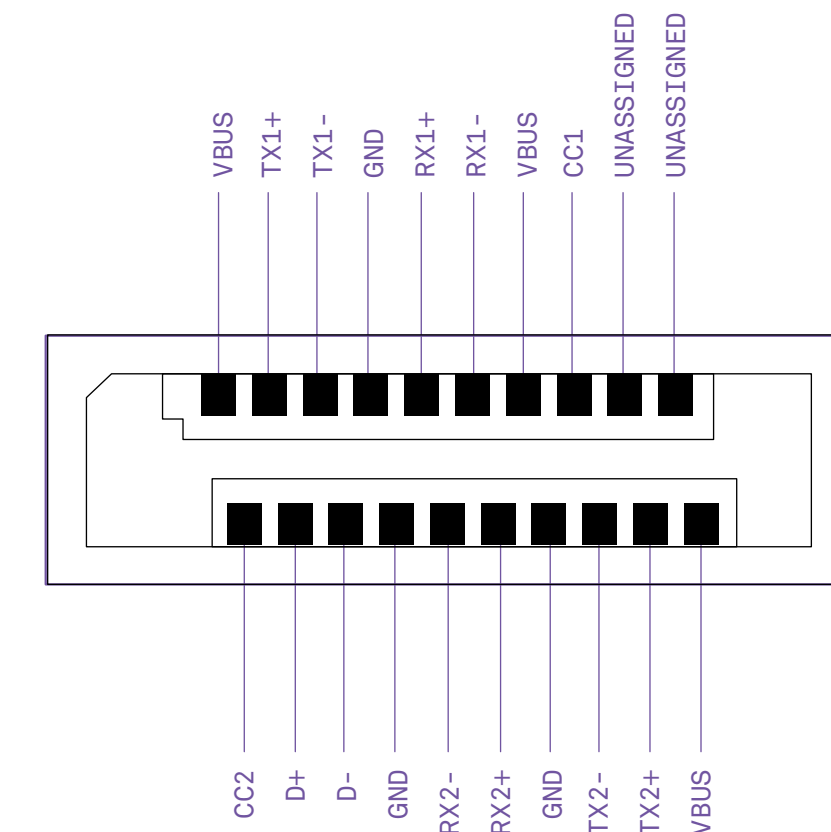

3.14 FRONT PANEL AUDIO CONNECTOR

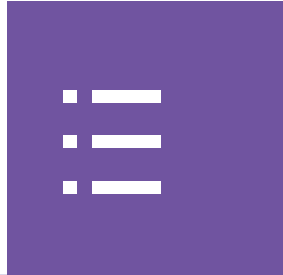

This connector connects to the front panel audio on the case.

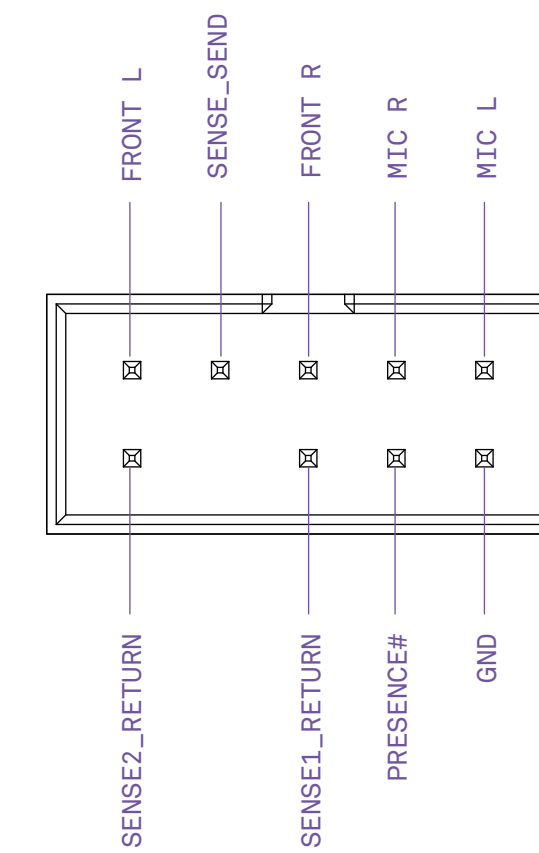
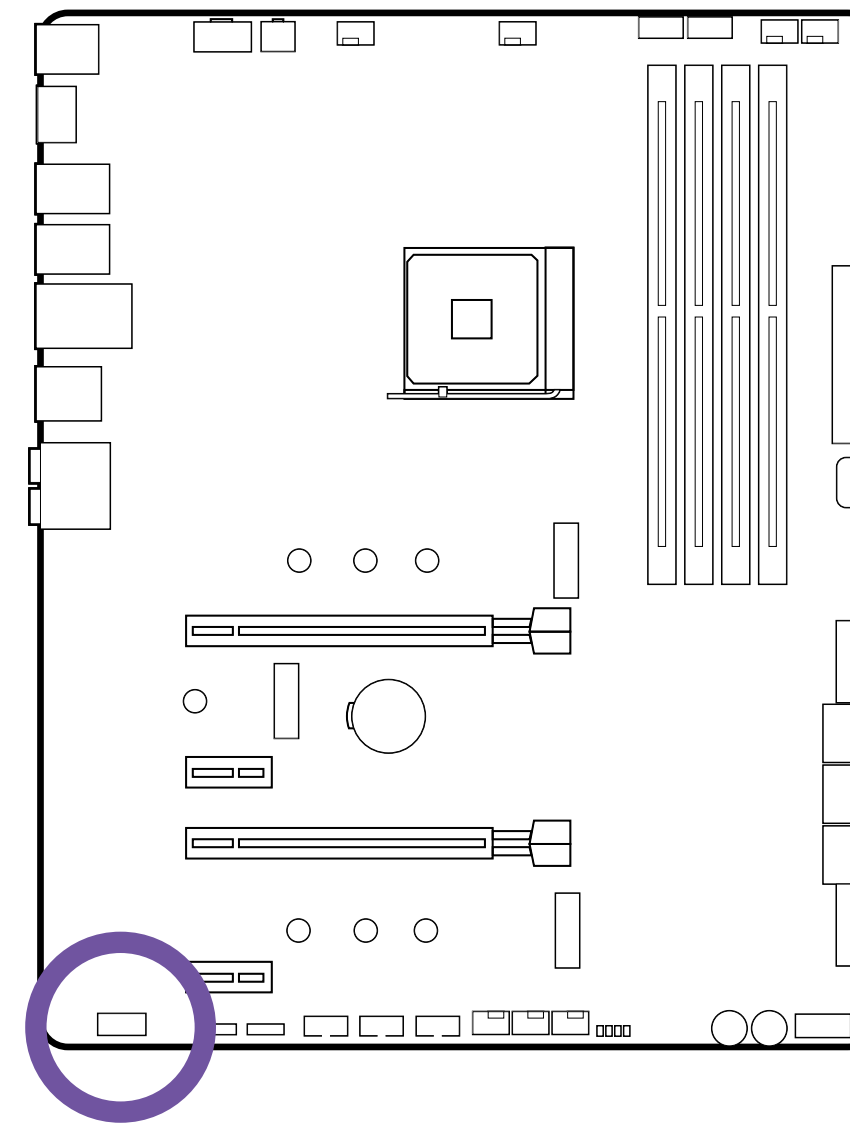

3.15 FRONT PANEL CONNECTOR



These connectors connect to the switches and indicator LEDs on the case.

IMPORTANT

- Please check the polarity of the pins to ensure your LEDs work properly.

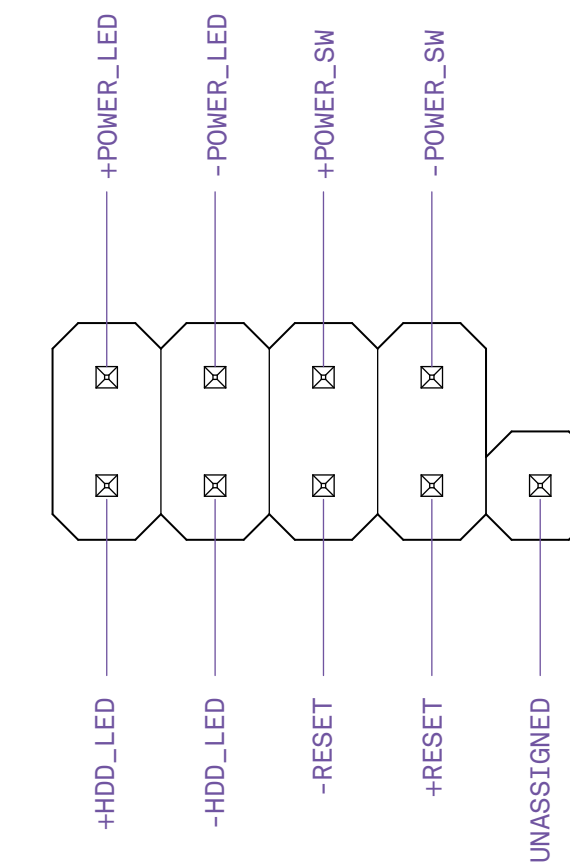
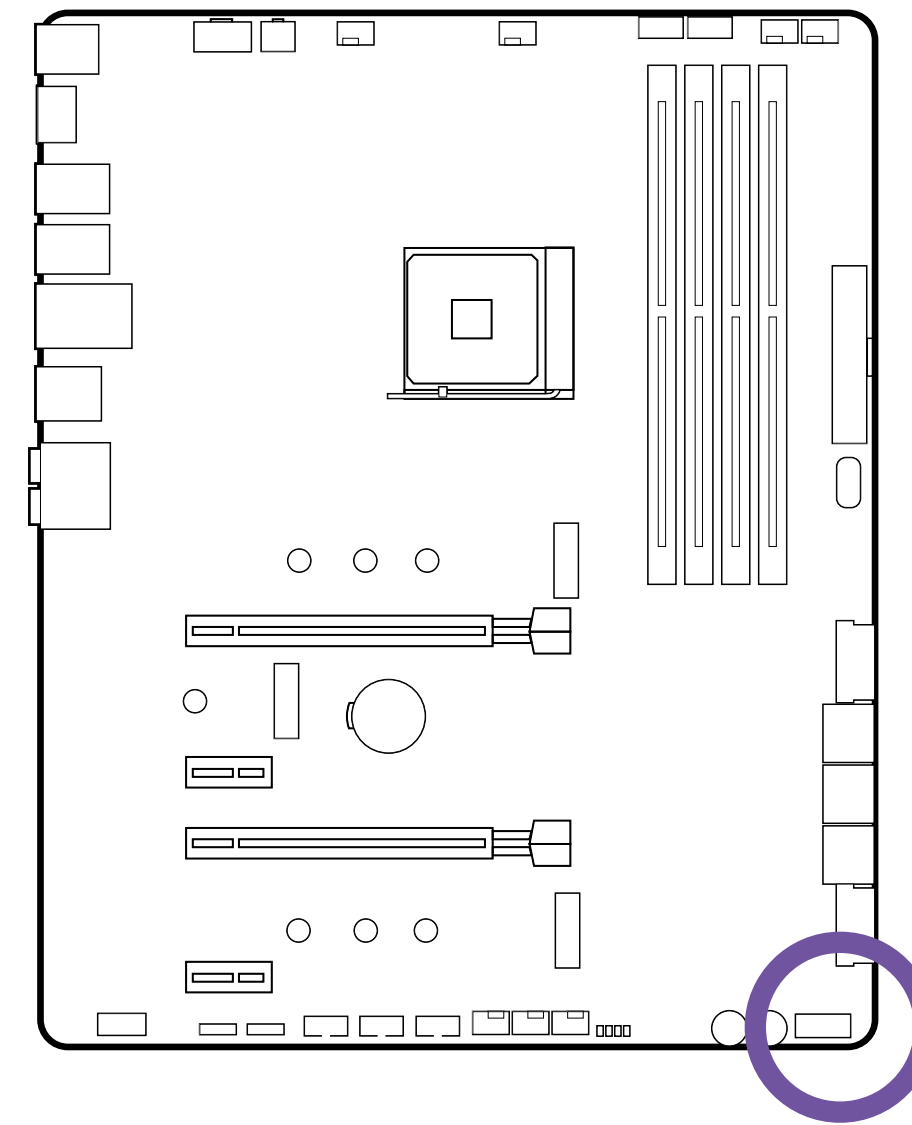

3.16 FAN CONNECTORS



The CPU_FAN connector supports 4-pin PWM fans up to 2A (24W). The AIO_PUMP and the five SYS_FAN connectors automatically detects if a 4-pin PWM(Pulse Width Modulation) or 3-pin fan is in use and supports up to 2A(24W) each. The fan speeds can be adjusted within CAM.

NOTE

- CAM is required to control the fans within Windows.

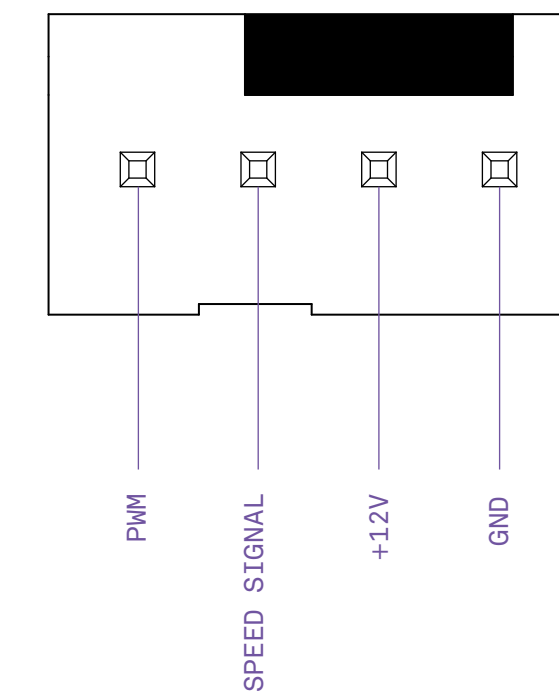
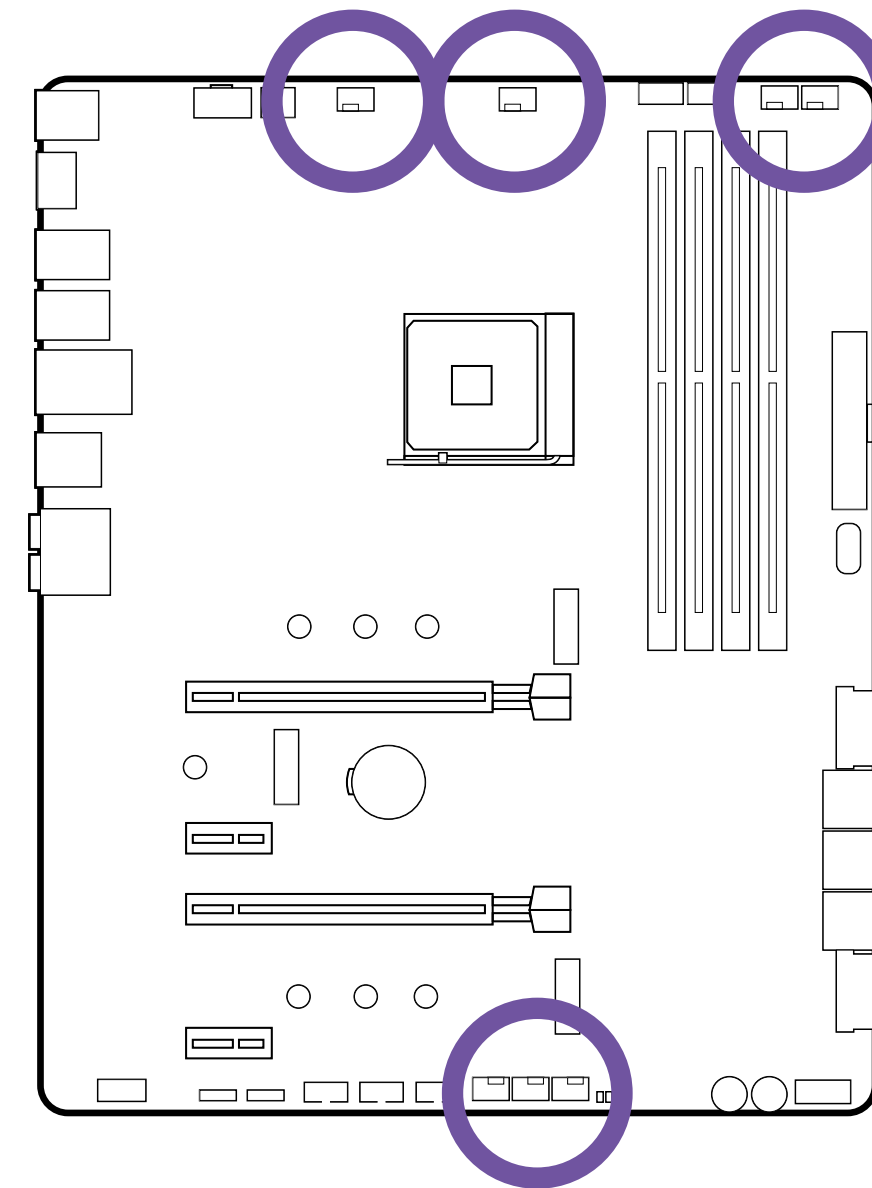

3.17 NZXT RGB CONNECTORS



There are two NZXT RGB headers located on the motherboard. The NZXT RGB ports are compatible with NZXT lighting accessories. Each channel supports up to 40 LEDs and up to 6 accessories.

NOTE

- CAM is required to control the lighting within Windows.
- Before installing or removing your lighting accessories, please power off your system and unplug the power cord from the power supply.

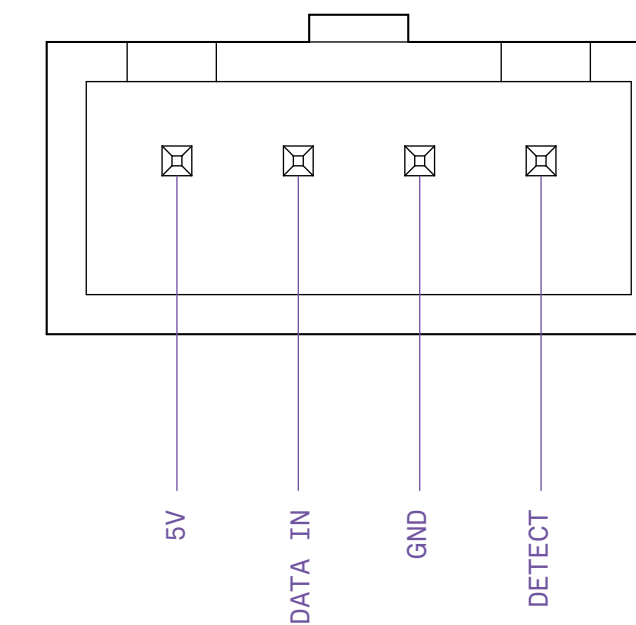
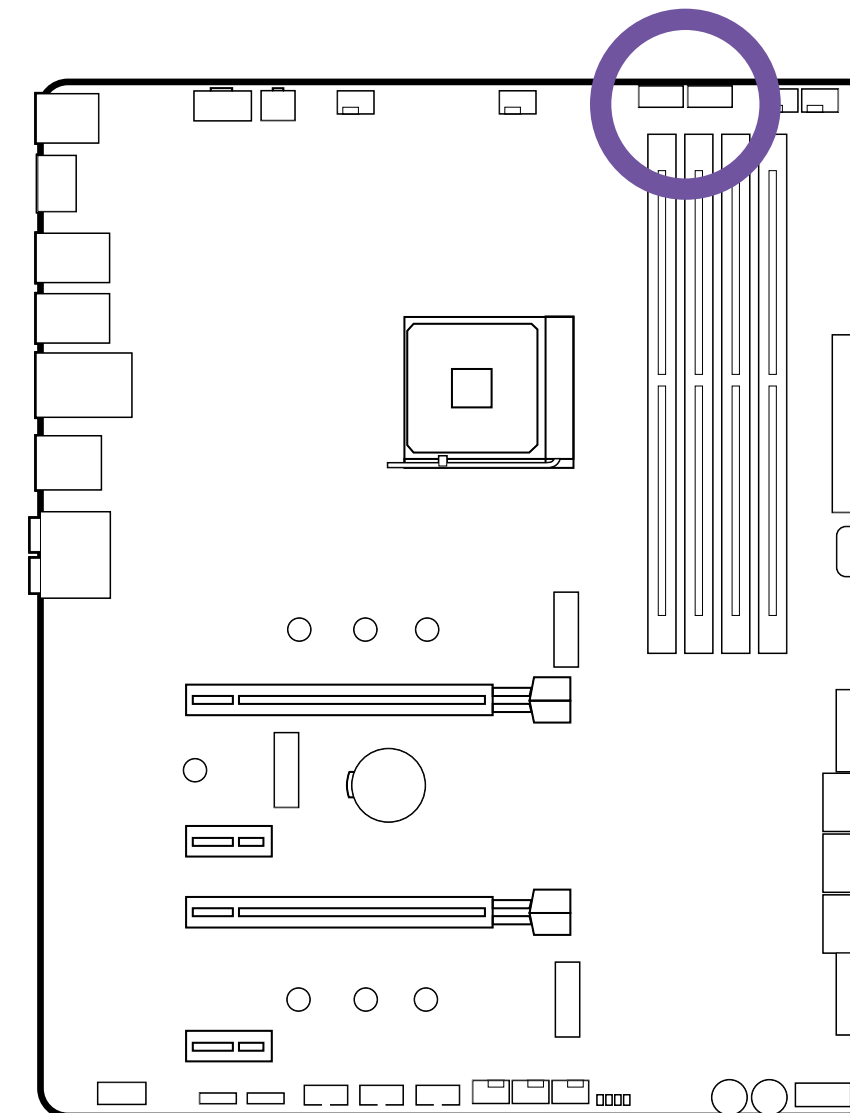

3.18 5V ADDRESSABLE RGB CONNECTOR



A 5V Addressable RGB is located on the motherboard. This port supports WS2812B addressable RGB LED strip (5V/Data/GND), with a maximum power rating of 3A (5V) and supports up to 40 LEDs.

NOTE

- Never install RGB LED cables in the wrong orientation to prevent damage to the motherboard and lighting accessories.
- CAM is required to control the lighting within Windows.
- Before installing or removing your lighting accessories, please power off your system and unplug the power cord from the power supply.

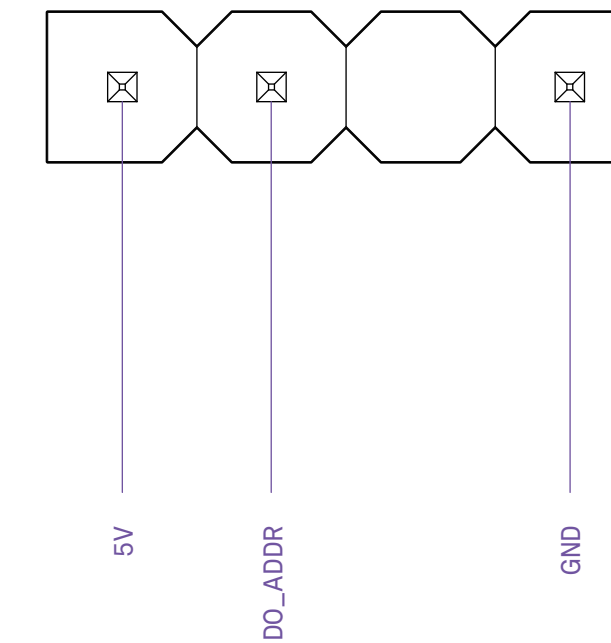
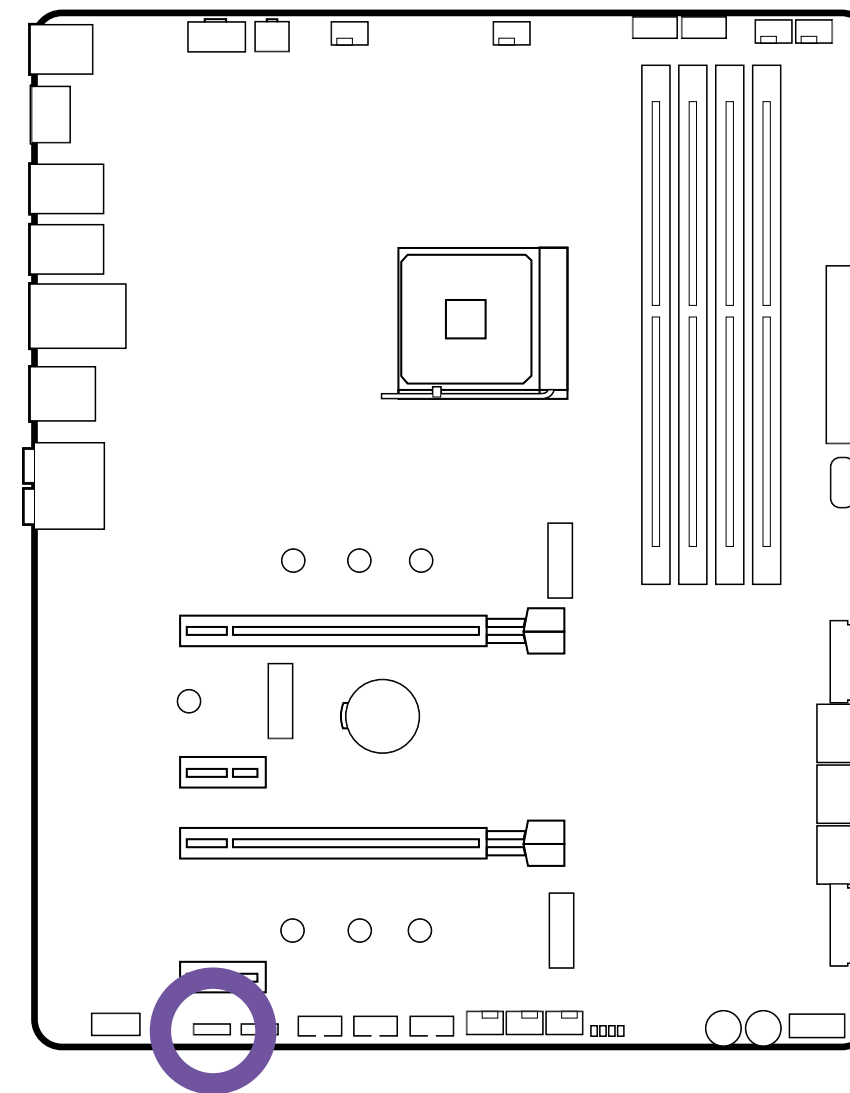

3.19 12V RGB CONNECTOR



A 12V RGB is located on the motherboard. This port supports standard 5050 RGB LED strip (12V/G/R/B), with a maximum power rating of 3A (12V) and length within 2 meters.

NOTE

- Never install RGB LED cables in the wrong orientation to prevent damage to the motherboard and lighting accessories.
- CAM is required to control the lighting within Windows.
- Before installing or removing your lighting accessories, please power off your system and unplug the power cord from the power supply.

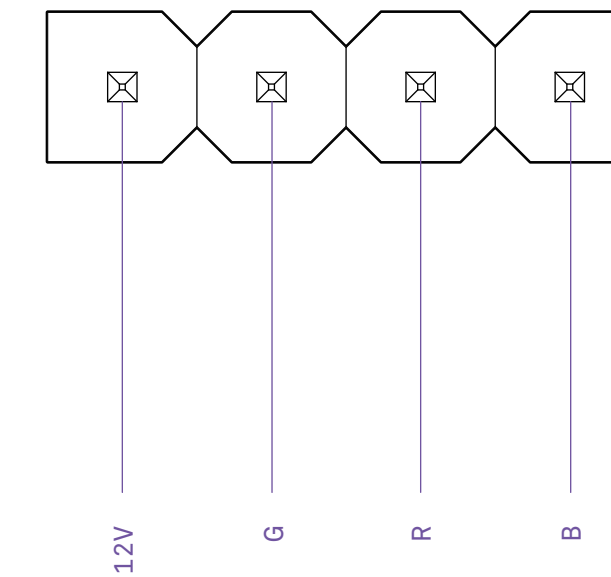
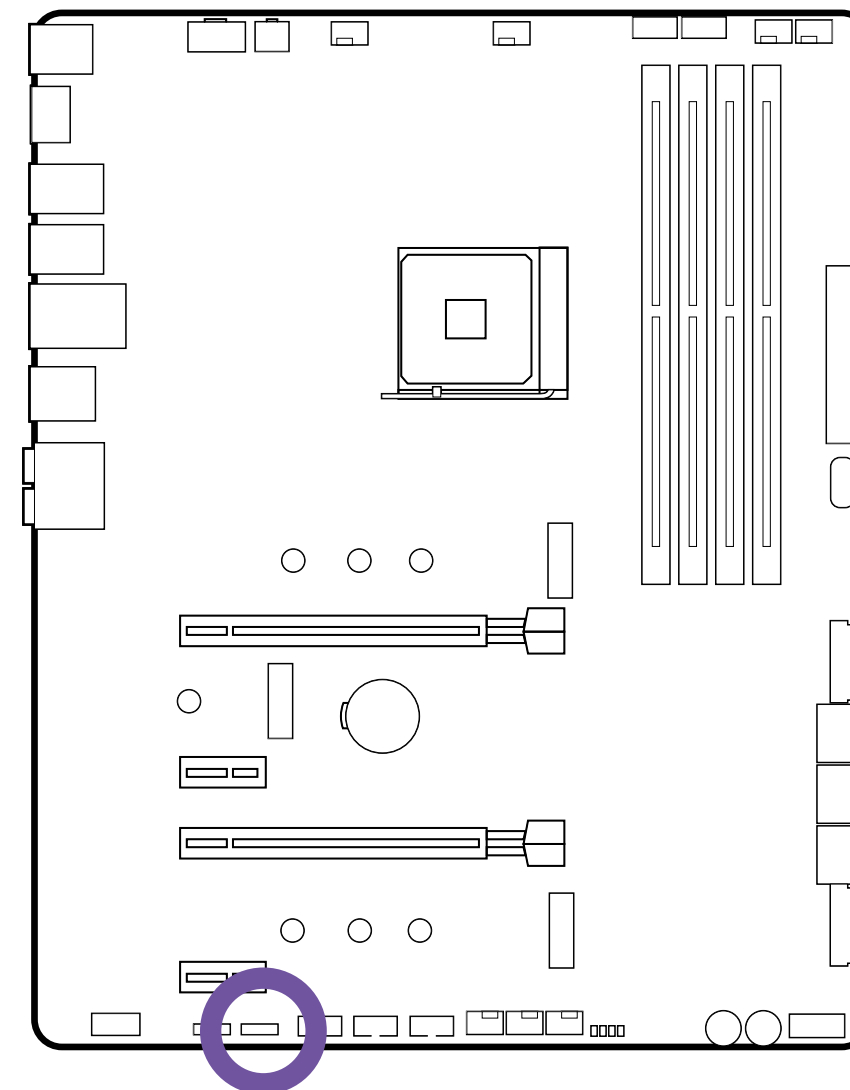

3.20 BUTTONS AND POST LEDS



Power and Reset Button

The power and reset button allow you to power on and reset the motherboard without connecting to a switch which is useful when testing.

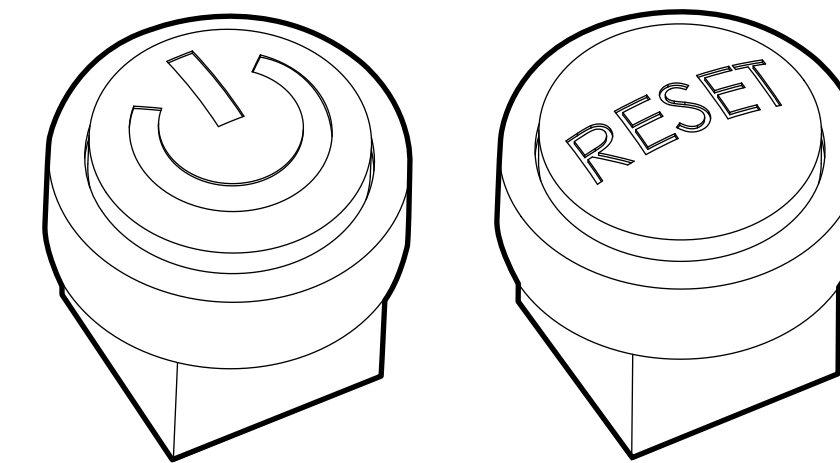
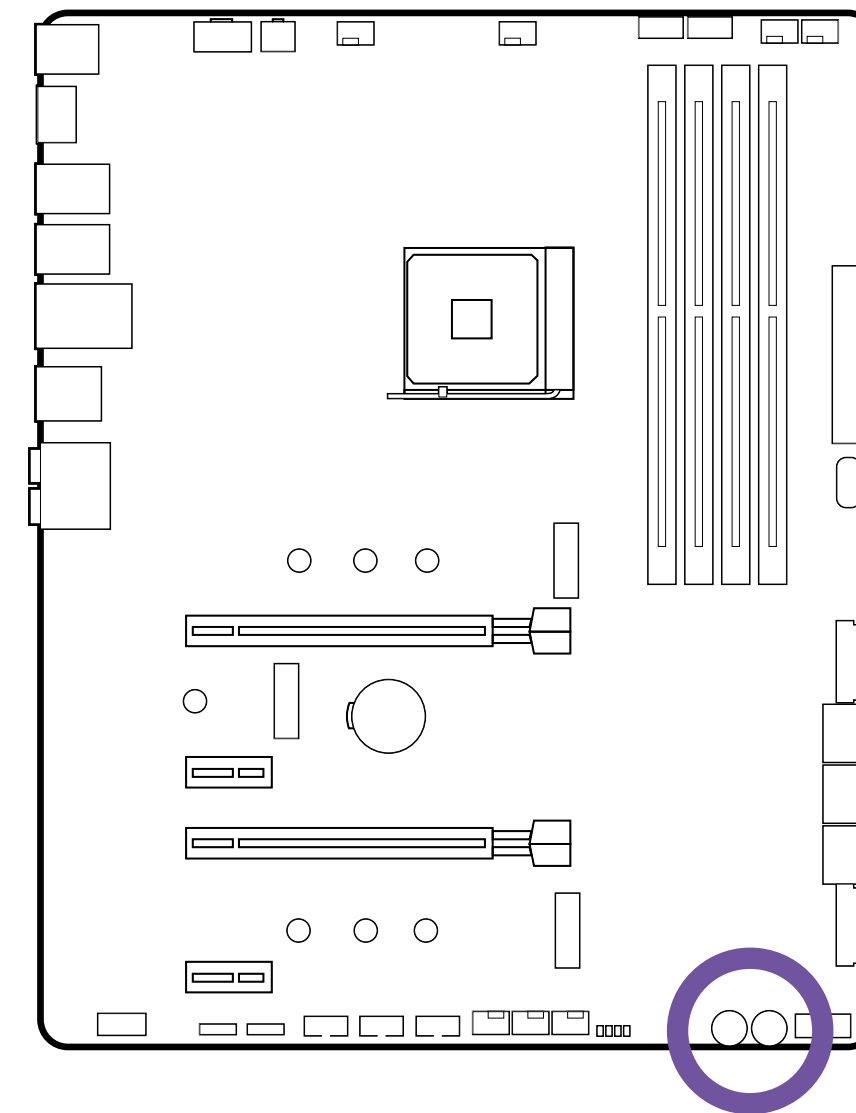

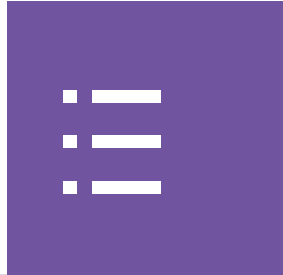

Clear CMOS Button

The Clear CMOS button located on the rear I/O can be used to revert BIOS settings to default. To clear CMOS, turn off the power and remove the AC power to the power supply. Allow 30 seconds to ensure no standby power exists. Press and hold the Clear CMOS button for 3 seconds.

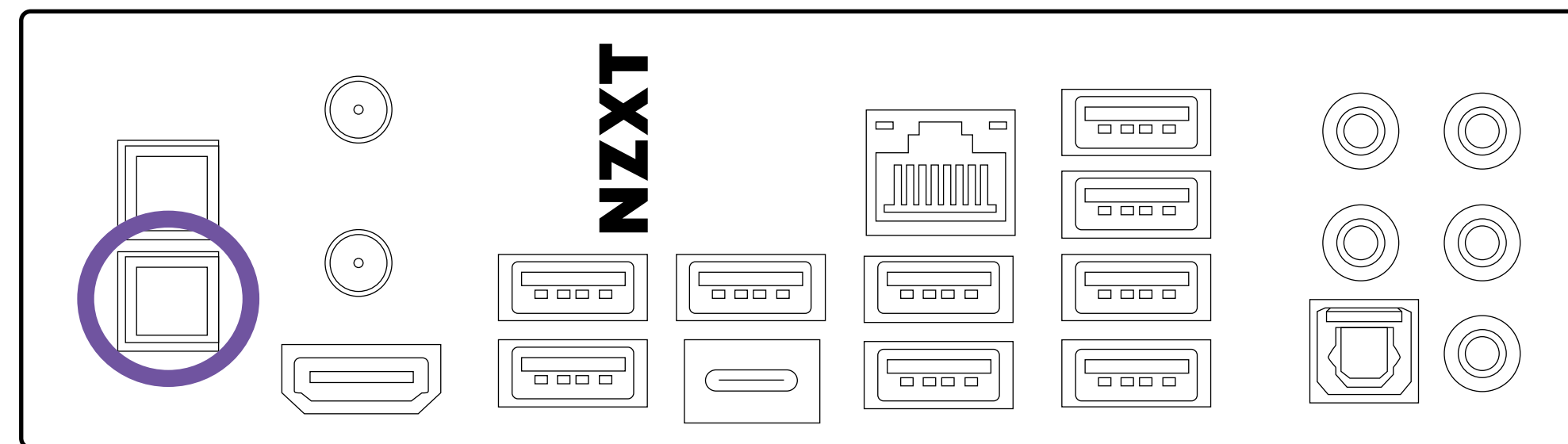



POST LEDs

Post LEDs diagnoses the computer when users power on their system. It will light up to indicate whether the CPU, memory, VGA or storage is dysfunctional. The lights go off if the four mentioned above are functioning normally.

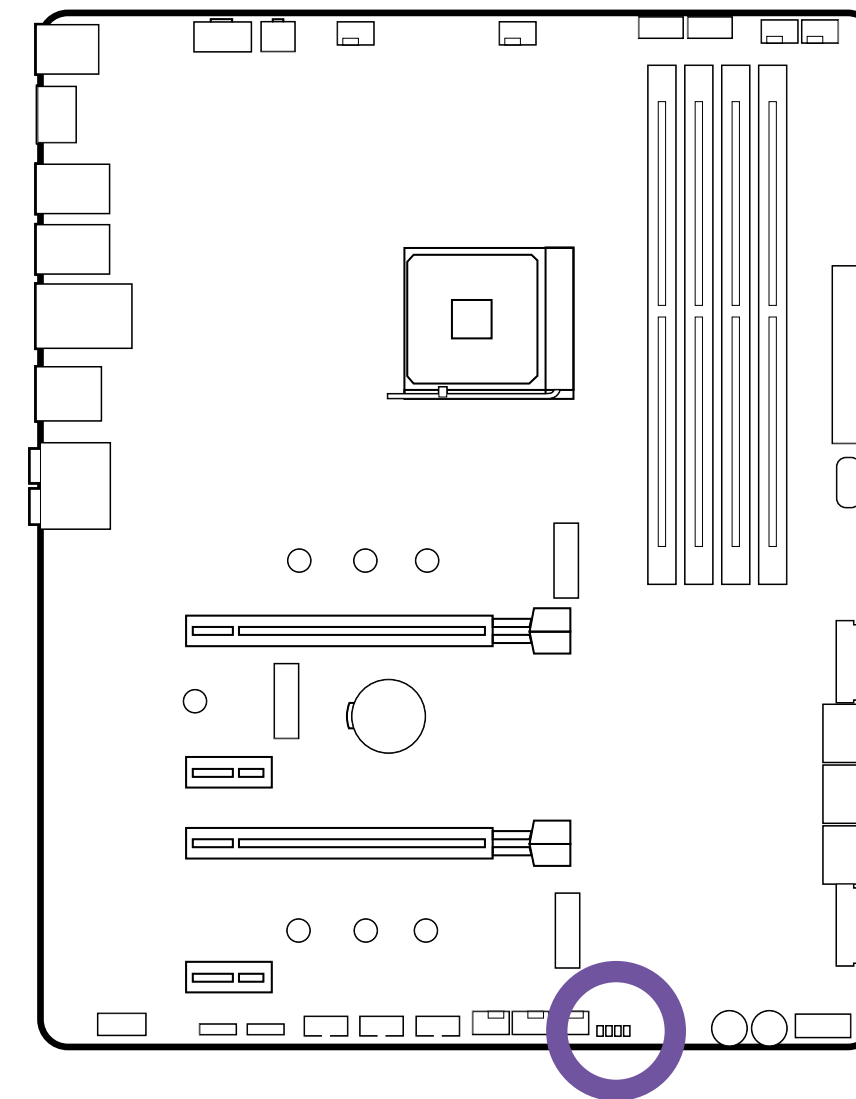

3.21 CMOS BATTERY



In the event that your BIOS settings can no longer be saved, it is likely the motherboard CMOS battery (CR2032) no longer holds a charge. You can access the battery and replace it by removing the metal cover.

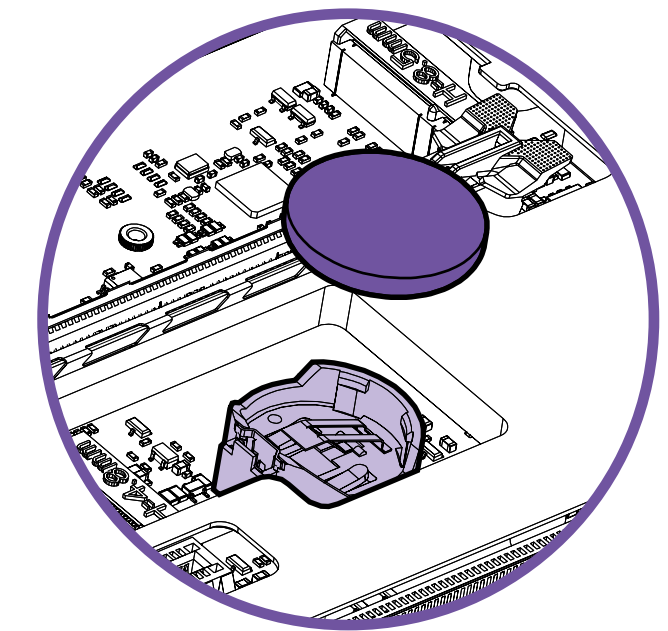
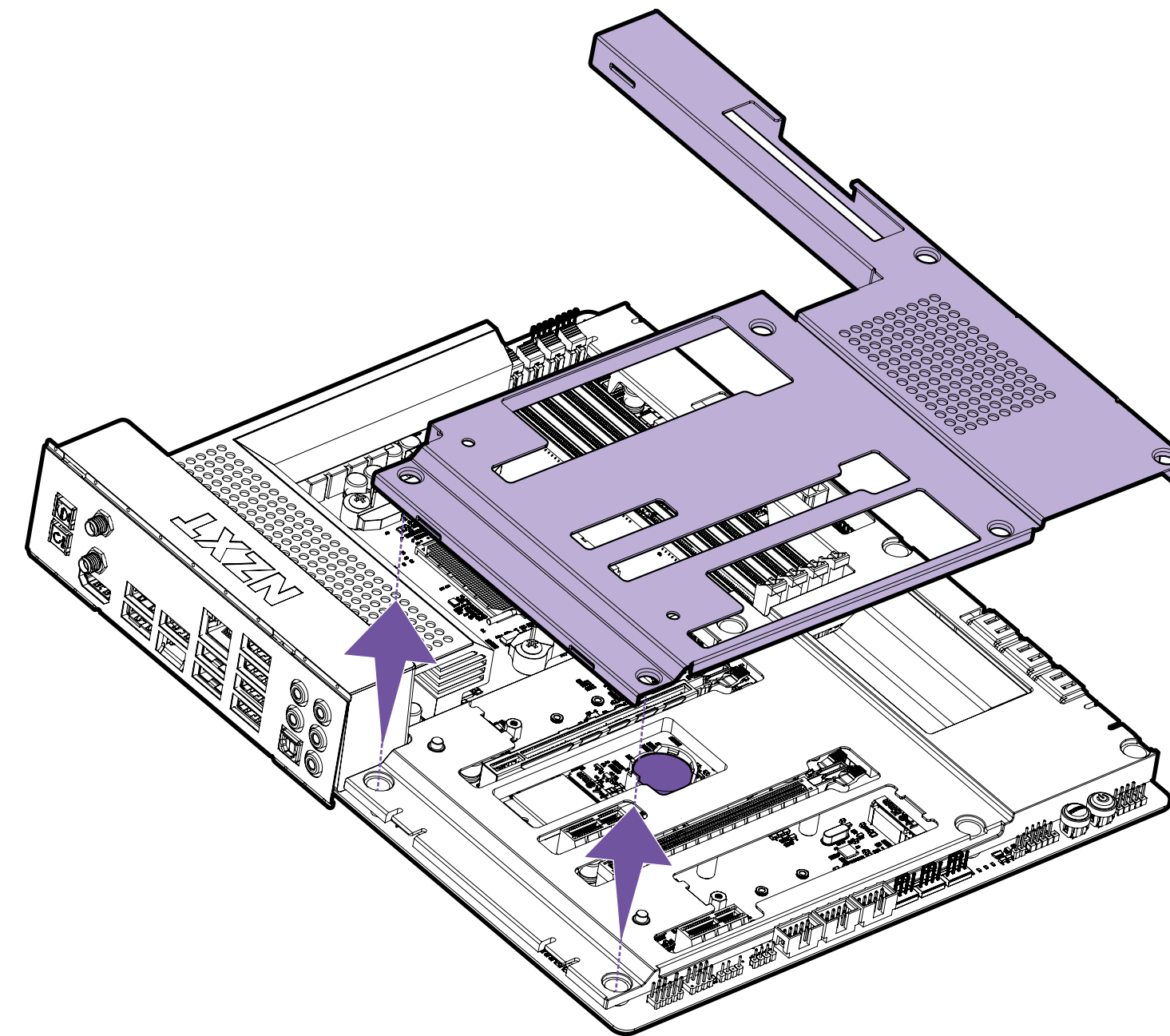

3.22 BIOS FLASHBACK



With a USB flash drive and the latest BIOS, you can update the BIOS without a CPU and you do not need to power on the system. To use the BIOS Flashback feature, perform the steps below.

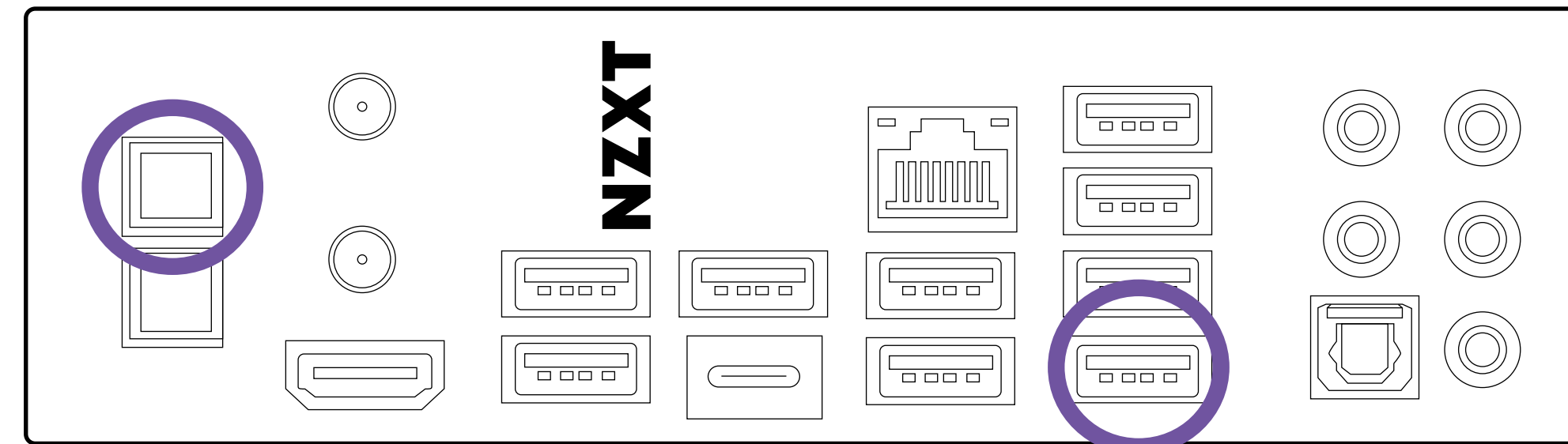

NOTE

- A separate PC system is needed to prepare the USB flash drive.
- If the LED turns solid green, this means the BIOS Flashback is not operating properly. Plug the USB drive to the USB BIOS Flashback port.



1. Download the latest BIOS file from NZXT's website: nzxt.com.
2. Extract the BIOS file from the zip file to a secure location and rename the BIOS file "creative.rom".
3. Prepare a USB flash drive and format it in FAT32 and copy "creative.rom" to the root directory on the flash drive.
4. Plug in the 24-pin power connector to the motherboard and turn on the power supply's AC switch. Do not power on the system.
5. Plug the USB flash drive into the USB connector labeled with "BIOS" on the rear IO panel.
6. Press the BIOS Flashback Switch for about 3 seconds to begin the process. The button will flash to indicate the process has been started.
7. Please wait until the LED stops blinking and has turned off, indicating the BIOS flashing process has been completed.



NZXT CAM

Download and install NZXT CAM from nzxt.com/camapp.

Descargue e instale NZXT CAM en nzxt.com/camapp.

Téléchargez et installez NZXT CAM depuis nzxt.com/camapp.

laden Sie NZXT CAM von nzxt.com/camapp herunter und installieren Sie die Software.

Scaricare e installare NZXT CAM da nzxt.com/camapp.

Baixe e instale o NZXT CAM de nzxt.com/camapp.

загрузите и установите приложение NZXT CAM со страницы nzxt.com/camapp.

nzxt.com/camapp 에서 NZXT CAM을 다운로드하여 설치하십시오.

NZXT CAMは nzxt.com/camapp からダウンロード・インストール可能です。

請從：nzxt.com/camapp 下載並安裝 NZXT CAM 軟件。

請從 nzxt.com/camapp 下載並安裝 NZXT CAM。

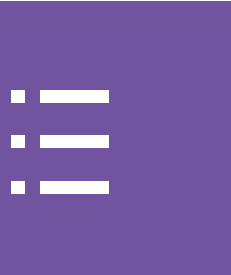

5.1 NZXT Global Warranty Policy.....A-2

5.4 Battery InformationA-13

5.2 Support and ServiceA-8

5.5 WEEE Statement.....A-14

5.3 Regulatory Notices.....A-11

5.6 Revision HistoryA-18

5.1 NZXT GLOBAL WARRANTY POLICY



This NZXT Global Warranty Policy governs the sale of products by NZXT to you.

I. WARRANTY LENGTH

Any replacement product will be covered under warranty for the remainder of the warranty period or thirty days, whichever is longer. Proof of purchase is required for warranty service.

II. WHO IS PROTECTED

The Warranty covers only NZXT products purchased by the original consumer.

NEW NZXT PRODUCT	WARRANTY LENGTH FOR PARTS
Computer Cases	2 Years
Temperature Meters	2 Years
Fans	2 Years
Lighting	2 Years
Accessories	2 Years
Kraken M Coolers	3 Years
Headset/Headphone	2 Years
Headset/Headphone Storage	2 Years
Mixer	2 Years
Motherboards	3 Years
Power Supply	10 Years
Kraken X/Z Coolers	6 Years
Mini ITX Case with PSU, AIO, and Riser Card	3-year warranty on case, riser card, and AIO. 10-year warranty on PSU.
REFURBISHED NZXT PRODUCT	WARRANTY LENGTH FOR PARTS
All NZXT Certified Refurbished Products	1 Years



III. WHAT IS AND IS NOT COVERED

Please note that our warranty is not an unconditional guarantee. If the product, in NZXT's reasonable opinion, malfunctions within the warranty period, NZXT will provide you at its sole discretion with a repaired or replacement product, either new or refurbished, with a similar function that is equal or greater in value depending on supply.

Our warranty does not cover the following:

- any product or serial number/warranty sticker modification applied without permission from NZXT;
- any damage that is not a manufacturing defect;
- damage, deterioration or malfunction resulting from: accident, abuse, misuse, neglect, fire, water, lightning, or other acts of nature, unauthorized product modification or failure to follow instructions included with the product;
- improper installation, unauthorized alterations or modifications, or repair or attempted repair by anyone not authorized by NZXT;
- shipping or transport damage (claims must be made with the carrier);
- normal wear and tear.

NZXT does not warrant that this product will meet your requirements. It is your responsibility to determine the suitability of this product for your purpose. For NZXT Store orders, we cover two way return shipping for all exchanges and returns. For all other authorized dealers, NZXT Support does not cover return shipping and only covers one way shipping from NZXT back to the end user for exchanges. Two way expedited shipping is provided for all PSUs covered under the Less Than Three program, indiscriminate of purchase location, provided the location is an approved NZXT reseller.

IV. EXCLUSION OF DAMAGES (DISCLAIMER)

NZXT's sole obligation and liability under this warranty is limited to the repair or replacement of a defective product with either a new or refurbished product with a similar function that is equal or greater in value at our option. NZXT shall not, in any event, be liable for any incidental or consequential damage, including but not limited to damages resulting from interruption of service and loss of data, business, or for liability in tort relating to this product or resulting from its use or possession.

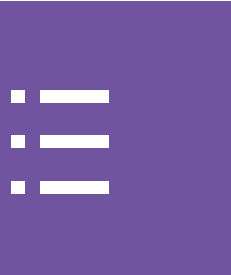

V. LIMITATIONS OF IMPLIED WARRANTIES

Here are no other warranties, expressed or implied, including but not limited to those of merchantability or fitness for a particular purpose. The duration of implied warranties is limited to the warranty length specified in Paragraph I.

VI. TO OBTAIN TECHNICAL SUPPORT

If you have already referenced your product owner's manual and still need help, you may contact us by phone at +1 (800) 228-9395, by email at service@nzxt.com, or visit the NZXT Support site at nzxt.com/customer-support.

VII. HOW TO OBTAIN A WARRANTY SERVICE FROM NZXT

To receive a warranty service for your product when purchased directly from NZXT, you must submit a request via the NZXT Support site outlining the problem. If a technician deems the product defective or requiring testing, you will be required to provide a copy of your proof of purchase, which will enable you to submit a Return Merchandise Authorization "RMA" request.

Once approved, you'll receive an RMA number, upon which you will be asked to ship the defective item back to NZXT with the RMA number clearly marked or labelled on the package. NZXT recommends that appropriate measures are taken to safeguard the product from damage during shipping.



VIII. APPLICABLE LAW AND ADDITIONAL LEGAL RIGHTS FOR CONSUMERS

This warranty gives you specific legal rights. These conditions are governed and construed in accordance with the laws of California (with exception of its conflict of law provisions), and the application of the United Nations Convention of Contracts for the International Sale of Goods is expressly excluded. The non-exclusive jurisdiction of the courts of California is agreed, which means that you may bring a claim to enforce your consumer protection rights in connection with this Global Warranty in the country which you have your habitual residence where you may have additional rights. These rights may vary.

For original consumers who are covered by consumer protection laws or regulations in their country, state, or province of purchase or, if different, their country, state, or province of residence, the benefits conferred by this warranty are in addition to all rights and remedies conveyed by such consumer protection laws and regulations. To the extent that liability under such consumer laws can be limited, NZXT's liability is limited, and its sole option, to repair or replacement, either new or refurbished, with a similar function that is equal or greater in value depending on supply.

In the United Kingdom:

- For NZXT products sold to customers in the UK, during the expected lifespan of your product your legal rights entitle you to the following:
 - > Up to 30 days: if your goods are faulty, then you can get an immediate refund.
 - > Up to six months: if your goods can't be repaired or replaced, then you're entitled to a full refund, in most cases.
 - > Up to six years: if your goods do not last a reasonable length of time you may be entitled to some money back.
- If the person seeking to rely on the guarantee is not the original consumer, the NZXT Warranty will cover the product in relation to that person provided that they are able to provide proof of the transfer of the benefit of the guarantee from the original consumer.
- The implied warranties under the Consumer Rights Act 2015 says that your goods must be as described, fit for all purposes for which such goods are usually supplied, and of satisfactory quality.

In the EU:

- If you are a consumer and have your habitual residence in the EU, you additionally enjoy the protection afforded to you by provisions that cannot be derogated from by agreement by virtue of the law where you have your habitual residence.



IX. WARRANTY SERVICE FROM RESELLERS

In the event that a warranty service is sought, you must provide proof of purchase (store receipt or invoice) in order to receive the service and if deemed necessary, repair or replacement product.

In North America:

Within the first 60 days after purchase, please return your product (or for power supplies installed within our enclosures, just the failed power supply) to your dealer or reseller for a replacement. If the product is still within warranty and you can no longer return it to your dealer, please contact NZXT Customer Support (see above) for assistance and instructions. NZXT will not accept returns without prior approval and an RMA number.

In Europe:

Within the first year after purchase, please return your product (or for power supplies installed within our enclosures, just the failed power supply) to your dealer or reseller for a replacement. If the product is still within warranty and you can no longer return it to your dealer, please contact NZXT Customer Support (see above) for assistance and instructions. NZXT will not accept returns without prior approval.

In Australasia:

Within the first two years after purchase, please return your product (or for power supplies installed within our enclosures, just the failed power supply) to your dealer or reseller for a replacement. If the product is still within warranty and you can no longer return it to your dealer, please contact NZXT Customer Support (see above) for assistance and instructions. NZXT will not accept returns without prior approval.

The cost of shipping will be borne at the first instance by you; however, if the purchased item is defective, NZXT will reimburse reasonable postage or transportation of costs.

Outside North America, Europe, and Australasia:

If your product needs to be returned within the warranty period, please contact the retailer or distributor from whom you purchased the product.



X. NZXT.COM STORE RETURNS/EXCHANGE POLICY

Eligible products under this NZXT Warranty qualify for a full refund or exchange only with an authorized RMA number and if the item is returned to the NZXT.com store inventory within 30 days of purchase. Returns are not allowed beyond 30 days of the purchase date. The NZXT.com Store reserves the right to deny any return or exchange. Refunds will be credited to the original method of payment. To initiate a return, simply submit a request via NZXT support site.

- > Visit nzxt.com/warranty and support.nzxt.com for information on warranty coverage and service.
- > Visite el sitio Web nzxt.com/warranty y support.nzxt.com para obtener información sobre la cobertura y el servicio de la garantía.
- > Visitez nzxt.com/warranty et support.nzxt.com pour les informations de la couverture de la garantie et du service.
- > Informationen zu Geltungsbereich und Service der Garantie finden Sie unter support.nzxt.com und nzxt.com/warranty.
- > Visitare il sito nzxt.com/warranty e support.nzxt.com per informazioni sulla copertura e sul servizio della garanzia.
- > Visite nzxt.com/warranty e support.nzxt.com para obter informações sobre a cobertura da garantia e assistência.
- > Подробную информацию об условиях гарантийного обслуживания см. на веб-сайте nzxt.com/warranty и support.nzxt.com.
- > 제품 보증 범위와 서비스 정보를 확인하시려면 nzxt.com/warranty 또는 support.nzxt.com 을 방문해 주시기 바랍니다.
- > 保証範囲およびサービスに関する情報については、support.nzxt.com と nzxt.com/warranty にアクセスしてください。
- > 请造访 nzxt.com/warranty 和 support.nzxt.com 了解保修范围和服务的信息。
- > 請訪問 nzxt.com/warranty 和 support.nzxt.com 了解產品保固範圍和更多服務訊息。

NZXT, Inc./ 15736 E Valley Blvd, City of Industry, CA 91744, USA
NZXT Europe GmbH/ Industriering Ost 66 | 47906 Kempen | Germany
+1 (800) 228-9395 / service@nzxt.com / [NZXT.com](https://nzxt.com)



SUPPORT AND SERVICE

If you have any questions or problems with the NZXT product you purchased, please don't hesitate to contact us using our support system. support.nzxt.com

Please include a detailed explanation of your problem and your proof of purchase. For comments and suggestions, you can e-mail our design team, designer@nzxt.com. Lastly we would like to thank you for your support by purchasing this product.

For more information about NZXT, please visit us online. NZXT Website: NZXT.com

SOPORTE Y SERVICIO

Si tiene preguntas o problemas con el producto NZXT que usted compró, no dude en ponerse en contacto con service@nzxt.com y suministrar una explicación detallada de su problema así como su prueba de compra.

Puede hacer consultas sobre piezas de repuesto en support.nzxt.com.

Para comentarios y sugerencias, escriba un mensaje de correo electrónico a nuestro equipo de diseño: designer@nzxt.com. Gracias por comprar un producto NZXT. Para más información acerca de NZXT, visítenos en línea. Página web de NZXT: NZXT.com

SUPPORT ET SERVICE

Si vous avez des questions ou des problèmes avec le produit NZXT que vous avez acheté, n'hésitez pas à contacter service@nzxt.com avec une description détaillée de votre problème et votre preuve d'achat. Vous pouvez aussi commander des pièces de remplacement auprès support.nzxt.com. Pour les commentaires et les suggestions, envoyez un email à notre équipe de design, designer@nzxt.com.

Merci d'avoir acheté ce produit de NZXT. Pour plus d'informations sur NZXT, visitez notre site Web. Site Web de NZXT : NZXT.com

KUNDENDIENST UND SERVICE

Falls Fragen oder Probleme bezüglich Ihres NZXT-Produktes auftreten, wenden Sie sich bitte mit einer detaillierten Problembeschreibung und Ihrem Kaufbeleg an service@nzxt.com.

Ersatzteile können Sie unter support.nzxt.com anfragen.

Kommentare und Anregungen senden Sie bitte per designer@nzxt.com an unser Designteam. Vielen Dank, dass Sie ein NZXT-Produkt erworben haben. Weitere Informationen über NZXT erhalten Sie im Internet. NZXT-Webseite: NZXT.com



ASSISTENZA E SERVIZIO

In caso di dubbi o problemi con il prodotto NZXT acquistato, non esitate a contattarci utilizzando il nostro sistema di assistenza. support.nzxt.com Includere una spiegazione dettagliata del problema e la prova di acquisto. Per commenti e suggerimenti, siete pregati di inviare un messaggio al nostro team di progettisti, all'indirizzo: designer@nzxt.com. Infine, vogliamo ringraziarvi del vostro supporto con l'acquisto di questo prodotto. Per altre informazioni su NZXT, visitate il nostro sito. Sito NZXT: NZXT.com

ASSISTÊNCIA E MANUTENÇÃO

Caso tenha questões ou problemas com o produto NZXT adquirido, não hesite em contactar-nos através do endereço service@nzxt.com fornecendo a explicação detalhada do seu problema e a prova de compra. Poderá solicitar peças de substituição através do endereço support.nzxt.com. Para comentários e sugestões, contacte a nossa equipa de design através do endereço de e-mail, designer@nzxt.com. Obrigado por ter adquirido um produto NZXT. Para mais informações acerca da NZXT, visite-nos online. Web site da NZXT: NZXT.com

СЛУЖБА ПОДДЕРЖКИ И ОБСЛУЖИВАНИЯ

В случае возникновения вопросов или неисправностей в приобретенных вами продуктах NZXT обращайтесь по адресу: service@nzxt.com с подробным описанием проблемы и подтверждением покупки. О наличии запчастей можно узнать, обратившись по адресу: support.nzxt.com. Замечания и предложения отправляйте в адрес нашей группы разработчиков: designer@nzxt.com. Благодарим вас за покупку продукта NZXT. Более подробная информация о компании NZXT представлена на наших веб-сайтах. Веб-сайт NZXT: NZXT.com



지원 및 서비스

구입한 NZXT 제품과 관련하여 질문 또는 문제가 있을 경우, 당사의 지원 시스템 (support.nzxt.com)을 사용하여 문의하십시오. 문제를 자세히 기술하고 구매 증빙을 제출하십시오. 의견 또는 제안 사항이 있을 경우 당사 설계 팀에 designer@nzxt.com으로 이메일을 보내십시오. 마지막으로 이 제품을 구입하여 당사를 응원해 주셔서 감사합니다. NZXT에 대해 자세히 알려면 온라인으로 방문하십시오. NZXT 웹사이트: NZXT.com

サポートおよびサービス

購入されましたNZXTの製品に関するご質問または問題は、問題の詳細および購入の証明を添えて、ご遠慮なくservice@nzxt.comまでご連絡ください。交換部品はsupport.nzxt.comまでお尋ねください。ご意見およびご提案は弊社設計チーム、designer@nzxt.comまでメールを送信してください。NZXT製品をご購入いただきましてありがとうございます。NZXTに関する詳細は、インターネット上のウェブサイトをご覧ください。NZXT ウェブサイト: NZXT.com

支持和服务

如果有任何疑问或者在使用 NZXT 产品的过程中遇到任何问题,欢迎联络 service@nzxt.com,联络时请提供关于问题的详细说明及购买凭证。您可以向 support.nzxt.com 查询更换部件。如有任何意见或建议,欢迎致信我们的设计团队,电子邮件地址是 designer@nzxt.com。感谢您购买 NZXT 产品。有关 NZXT 的更多信息,请造访我们的在线网站。NZXT 网站: NZXT.com

支援和服務

如果在使用NZXT 產品的過程中有遇到任何問題或疑問，歡迎聯繫 service@nzxt.com，並請提供問題的詳細敘述及購買證明。您可以透過 support.nzxt.com 查詢更換部件。如有任何意見或建議，歡迎來信與設計團隊聯繫 designer@nzxt.com。最後，感謝您購買 NZXT 產品。有關 NZXT 的更多信息，請訪問我們的網站。NZXT 網站: NZXT.com



FCC COMPLIANCE STATEMENT

This equipment has been tested and found to comply with the limits for a Class B digital device, pursuant to Part 15 of the FCC Rules. These limits are designed to provide reasonable protection against harmful interference in a residential installation. This equipment generates, uses, and can radiate radio frequency energy and, if not installed and used in accordance with the instructions, may cause harmful interference to radio communications. However, there is no guarantee that interference will not occur in a particular installation. If this equipment does cause harmful interference to radio or television reception, which can be determined by turning the equipment off and on, the user is encouraged to try to correct the interference by one or more of the following measures:

- Reorient or relocate the receiving antenna
- Increase the separation between the equipment and the receiver
- Connect the equipment onto an outlet on a circuit different from that to which the receiver is connected
- Consult the dealer or an experienced radio/TV technician for help

Shielded interconnect cables and a shielded AC power cable must be employed with this equipment to ensure compliance with the pertinent RF emission limits governing this device. Changes or modifications not expressly approved by the system's manufacturer could void the user's authority to operate the equipment.



DECLARATION OF CONFORMITY

I. THIS DEVICE COMPLIES WITH PART 15 OF THE FCC RULES. OPERATION IS SUBJECT TO THE FOLLOWING CONDITIONS:

- This device may not cause harmful interference
- This device must accept any interference received, including interference that may cause undesired operation.

II. THIS DEVICE IS IN CONFORMITY WITH THE FOLLOWING EC/EMC DIRECTIVES:

EN 55022	Limits and methods of measurement of radio disturbance characteristics of information technology equipment
EN 61000-3-2	Disturbance in supply systems caused
EN 61000-3-3	Disturbance in supply systems caused by household appliances and similar electrical equipment "Voltage fluctuations"
EN 55024	Information technology equipment-immunity characteristics – Limits and methods of measurement
EN 60950	Safety for information technology equipment including electrical business Equipment

III. CE CONFORMITY

NZXT Inc, declares that this device is in compliance with the essential safety requirements and other relevant provisions set out in the European Directive.

IV. CANADIAN DEPARTMENT OF COMMUNICATIONS

This class B digital apparatus meets all requirements of the Canadian Interference-causing Equipment Regulations.
Cet appareil numérique de la classe B respecte toutes les exigences du Règlement sur le matériel brouilleur du Canada.

V. KOREAN CERTIFICATION MARK

Includes a KCC (Korean Communications Commission) certification number: KCC-R-R-ZXT-N7B55XT.

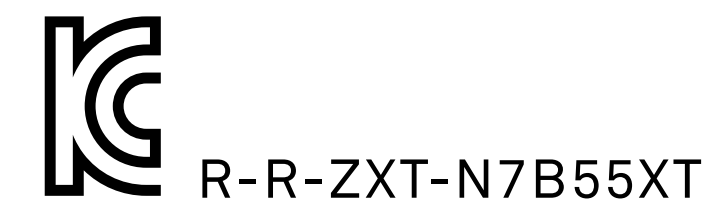



EUROPEAN UNION

Batteries, battery packs, and accumulators should not be disposed of as unsorted household waste. Please use the public collection system to return, recycle, or treat them in compliance with the local regulations.

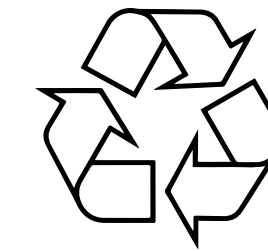

CALIFORNIA, USA

The button cell battery may contain perchlorate material and requires special handling when recycled or disposed of in California. For further information please visit:
<http://www.dtsc.ca.gov/hazardouswaste/perchlorate>

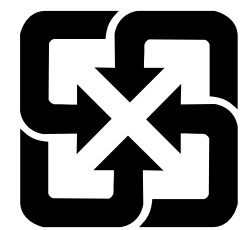

TAIWAN

For better environmental protection, waste batteries should be collected separately for recycling or special disposal.

CAUTION

- There is a risk of explosion, if battery is incorrectly replaced. Replace with the same or equivalent type recommended by the manufacturer.



ENGLISH

To protect the global environment and as an environmentalist, NZXT must remind you that...

Under the European ("EU") Directive on Waste Electrical and Electronic Equipment, Directive 2012/19/EU, effective February 14, 2014, products of "electrical and electronic equipment" cannot be discarded as municipal wastes, and manufacturers of covered electronics must take back such products at the end of their useful life. NZXT will comply with the product take back requirements at the end-of-life of NZXT products that are sold within the EU. You can return these products to local collection points.

ESPAÑOL

NZXT como empresa comprometida con la protección del medio ambiente, recomienda:

Bajo la directiva 2012/19/EU de la Unión Europea en materia de desechos y/o equipos electrónicos, con fecha de rigor desde el 14 de febrero de 2014, los productos clasificados como "eléctricos y equipos electrónicos" no pueden ser depositados en los contenedores habituales de su municipio, los fabricantes de equipos electrónicos, están obligados a hacerse cargo de dichos productos al termino de su período de vida. NZXT estará comprometido con los términos de recogida de sus productos vendidos en la Unión Europea al final de su periodo de vida. Usted debe depositar estos productos en el punto limpio establecido por el ayuntamiento de su localidad o entregar a una empresa autorizada para la recogida de estos residuos.



FRANÇAIS

En tant qu'écologiste et afin de protéger l'environnement, NZXT tient à rappeler ceci...

Au sujet de la directive européenne (EU) relative aux déchets des équipements électriques et électroniques, directive 2012/19/EU, prenant effet le 14 février 2014, que les produits électriques et électroniques ne peuvent être déposés dans les décharges ou tout simplement mis à la poubelle. Les fabricants de ces équipements seront obligés de récupérer certains produits en fin de vie. NZXT prendra en compte cette exigence relative au retour des produits en fin de vie au sein de la communauté européenne. Par conséquent vous pouvez retourner localement ces matériels dans les points de collecte.

DEUTSCH

Hinweis von NZXT zur Erhaltung und Schutz unserer Umwelt
Gemäß der Richtlinie 2012/19/EU über Elektro- und Elektronik-Altgeräte dürfen Elektro- und Elektronik-Altgeräte nicht mehr als kommunale Abfälle entsorgt werden. NZXT hat europaweit verschiedene Sammel- und Recyclingunternehmen beauftragt, die in die Europäische Union in Verkehr gebrachten Produkte, am Ende seines Lebenszyklus zurückzunehmen. Bitte entsorgen Sie dieses Produkt zum gegebenen Zeitpunkt ausschliesslich an einer lokalen Altgerätesammelstelle in Ihrer Nähe.

ITALIANO

Per salvaguardare l'ambiente globale, NZXT ricorda che:
La Direttiva Europea (UE) RAEE, in materia di rifiuti costituiti da apparecchiature elettriche ed elettroniche (Direttiva 2012/19/UE, in vigore dal 14 febbraio 2014), le apparecchiature elettriche ed elettroniche non possono essere smaltite tra i rifiuti municipali e i produttori di apparecchiature elettroniche sono tenuti a ritirare tali prodotti alla fine del ciclo di vita utile. NZXT è conforme ai requisiti inerenti al ritiro a fine vita dei prodotti NZXT venduti nell'UE. Questi prodotti devono essere conferiti nei centri di raccolta locali.



PORTUGUÊS

Para proteger o meio ambiente global e como um ambientalista, a NZXT lembra você de que...

Sob a Diretiva Europeia (“EU”) sobre Equipamentos Eletroeletrônicos Residuais, Diretiva 2012/19/EU, em vigor desde 14 de fevereiro de 2014, produtos de “equipamentos eletroeletrônicos” não podem ser descartados como lixo municipal e os fabricantes de eletrônicos cobertos devem receber de volta tais produtos no fim de sua vida útil. A NZXT cumprirá os requisitos de recolhimento do produto ao fim da vida útil dos produtos da NZXT vendidos dentro da UE. Você pode devolver esses produtos aos pontos de coleta locais.

РУССКИЙ

В целях поддержки движения защитников окружающей среды и охраны глобальной окружающей среды компания NZXT напоминает вам...

В соответствии с требованиями Директивы по утилизации электрического и электронного оборудования ЕС 2012/19/EU от 14 февраля 2014 г. продукты, являющиеся «электрическим и электронным оборудованием», должны утилизироваться отдельно от бытовых отходов, и производители оборудования, подпадающего под действие данной директивы, должны принимать такие продукты в случае их возврата в конце срока службы. NZXT будет соблюдать требования к возврату продукта производителю в конце срока службы продуктов NZXT, которые продаются на территории ЕС. Для возврата продуктов производителю созданы специализированные пункты приема.



한국어

지구를 보호하고, 환경에 친화적인 기업인 NZXT는 다음 사항을 안내합니다. 2014년 2월 14일부터 시행되는 Directive 2012/19/EU, 폐전기·전자제품에 관한 유럽연합("EU")의 지침에 따라 "전기·전자제품"은 일반폐기물로서 폐기할 수 없으며, 수명이 다한 제품은 반드시 해당 제품의 제조업체가 회수해야 합니다. NZXT는 유럽 내에서 판매되는 NZXT 제품에 대한 회수 지침을 준수합니다. 수명이 다한 제품은 해당 지역의 회수처에 반납하실 수 있습니다.

日本語

NZXTはかけがえのない地球環境を保護するために、廃電気・電子製品(WEEE)に関する欧州連合(EU)の指令を遵守します。WEEE指令2012/19/EU(2014年2月14日発効)で定められた通り、EU域内では電気機器・電子機器製品は地方自治体の廃棄物として廃棄できないため、対象となる電子機器メーカーは、製品が耐用年数に達した際に該当製品を引き取る必要があります。NZXTは、EU内で販売されるNZXT製品の耐用年数終了時の製品引き取り要件を遵守します。ユーザーの方におかれましては、該当製品を最寄りの回収場所にお出しいただけますよう、お願いいたします。

简体中文

作为一家环保型企业，为保护全球环境，NZXT提醒您.....根据 2014 年 2 月 14 日生效的欧洲 ("EU") 废弃电子电气设备指令——第 2012/19/EU 号指令的规定，“电气和电子设备”产品不可作为市政废物丢弃，相关电子产品的制造商须在此类产品使用寿命结束时将其收回。对于 NZXT 在欧盟地区售出的 NZXT 产品报废时，NZXT 将遵循该产品回收要求。您可以将这些产品送至当地的回收点。

中文

為保護全球環境，NZXT 提醒您... 依據 2014 年 2 月 14 日生效的歐盟 ("EU") 廢棄電子電氣設備指令第 2012/19 / EU 號指令規定，「電氣和電子設備」產品不得視為都市廢棄物丟棄，相關的電子產品製造商必須在產品使用壽命結束時將產品回收。對於歐盟境內銷售的 NZXT 產品，NZXT 將在產品使用壽命結束時，按照產品回收要求收回產品。您可以將這些產品送到當地的回收點。

5.6 REVISION HISTORY



Version 1.1, 2021/04/03