

# NZXT

## INTERNAL USB HUB

4 個內部 USB 擴充連接埠

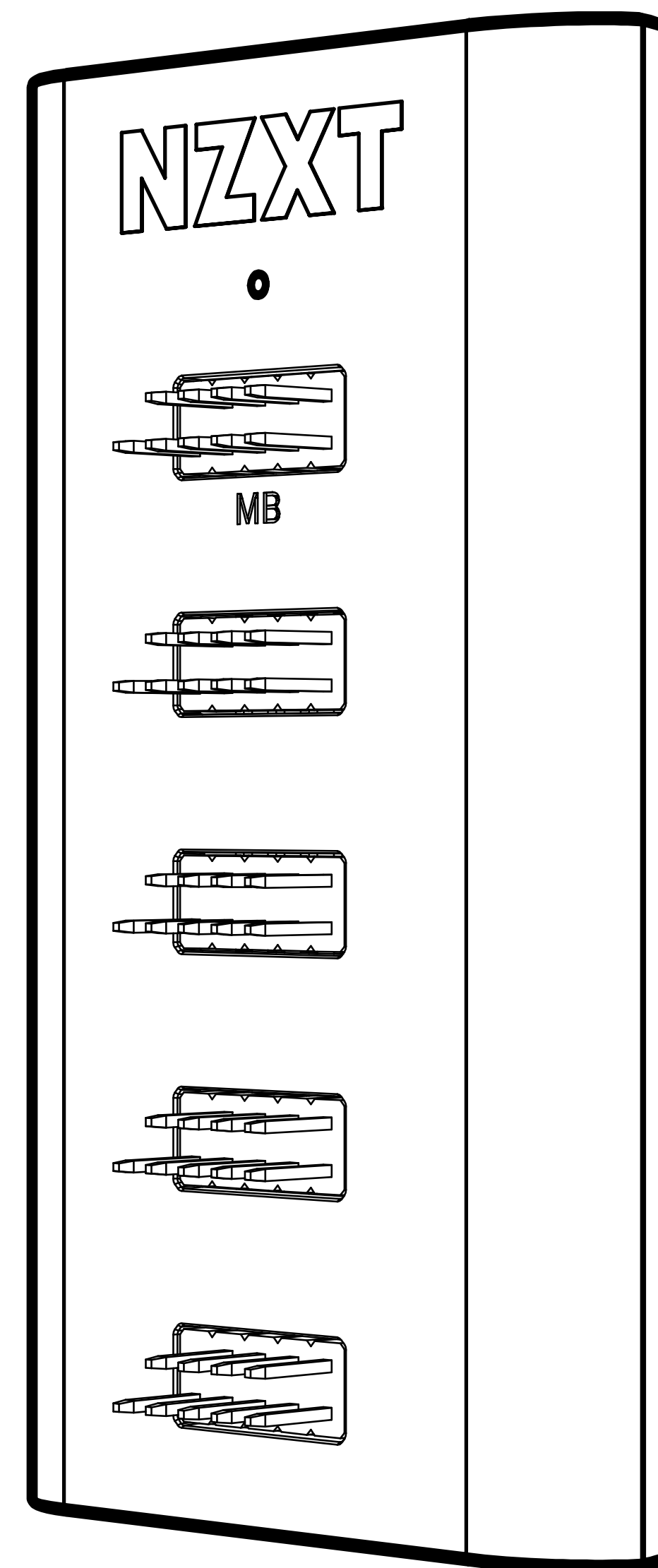

1. 零件表 ..... 02

2. 硬體介紹 ..... 03

3. 安裝 ..... 04

4. 疑難排解 ..... 08

5. 附錄 ..... A-1

# 1. 零件表



## A. USB內接擴充器

x1

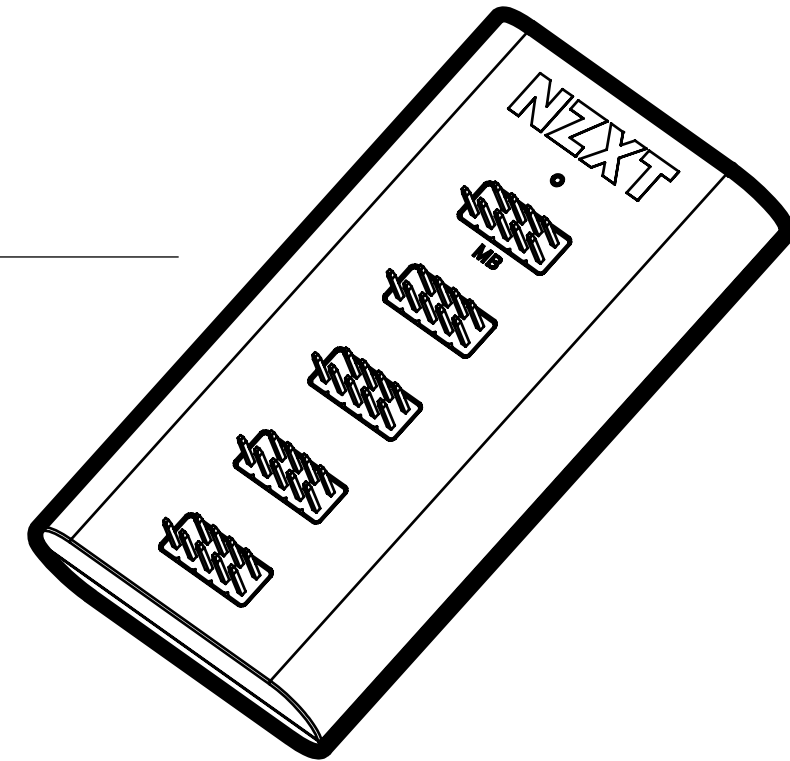

## B. SATA 電源線

x1

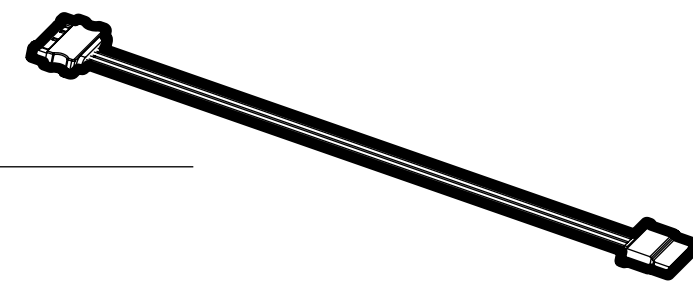

## C. USB 連接線

x1

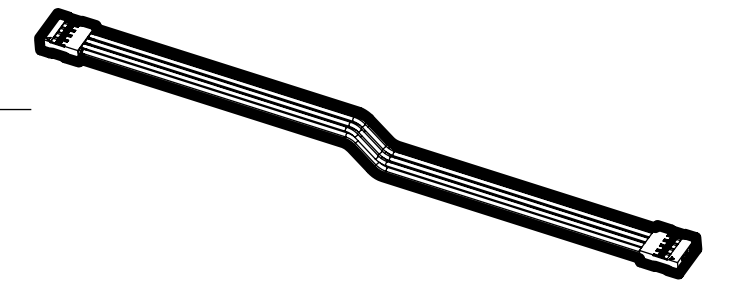

## D. 魔鬼氈束線帶

x1

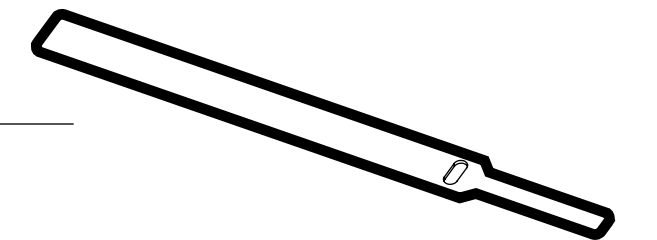

## E. 3M 雙面膠帶

x2

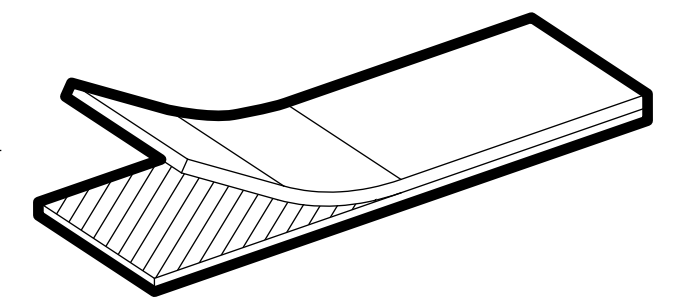

## 2. 硬體介紹



### A. 內部 USB 接頭

插入配備內部 USB 接頭的裝置

### B. 磁吸 (底部)

可將 Internal USB Hub 吸附於鋼鐵材質表面上

### C. 內部 USB 接頭 (MB)

插入隨附的主機板 USB 連接線

### D. LED 指示

電源開啟/關閉指示燈

### E. SATA 電源接頭

由此插入 SATA 電源線

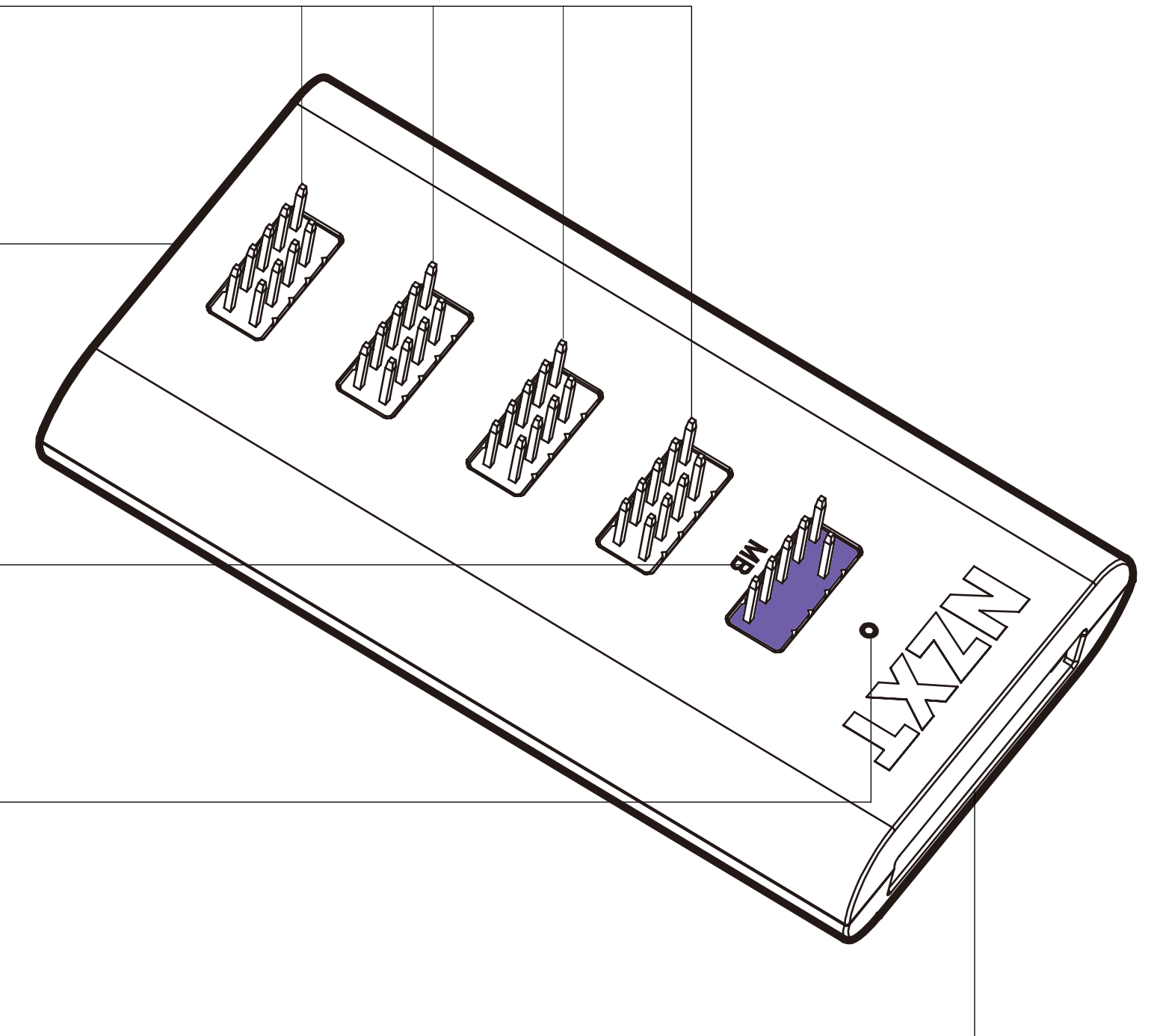

## 3.1 安裝



使用內嵌式磁鐵設計，可將 Internal USB Hub 安裝在機殼內的任何鋼鐵材質表面。

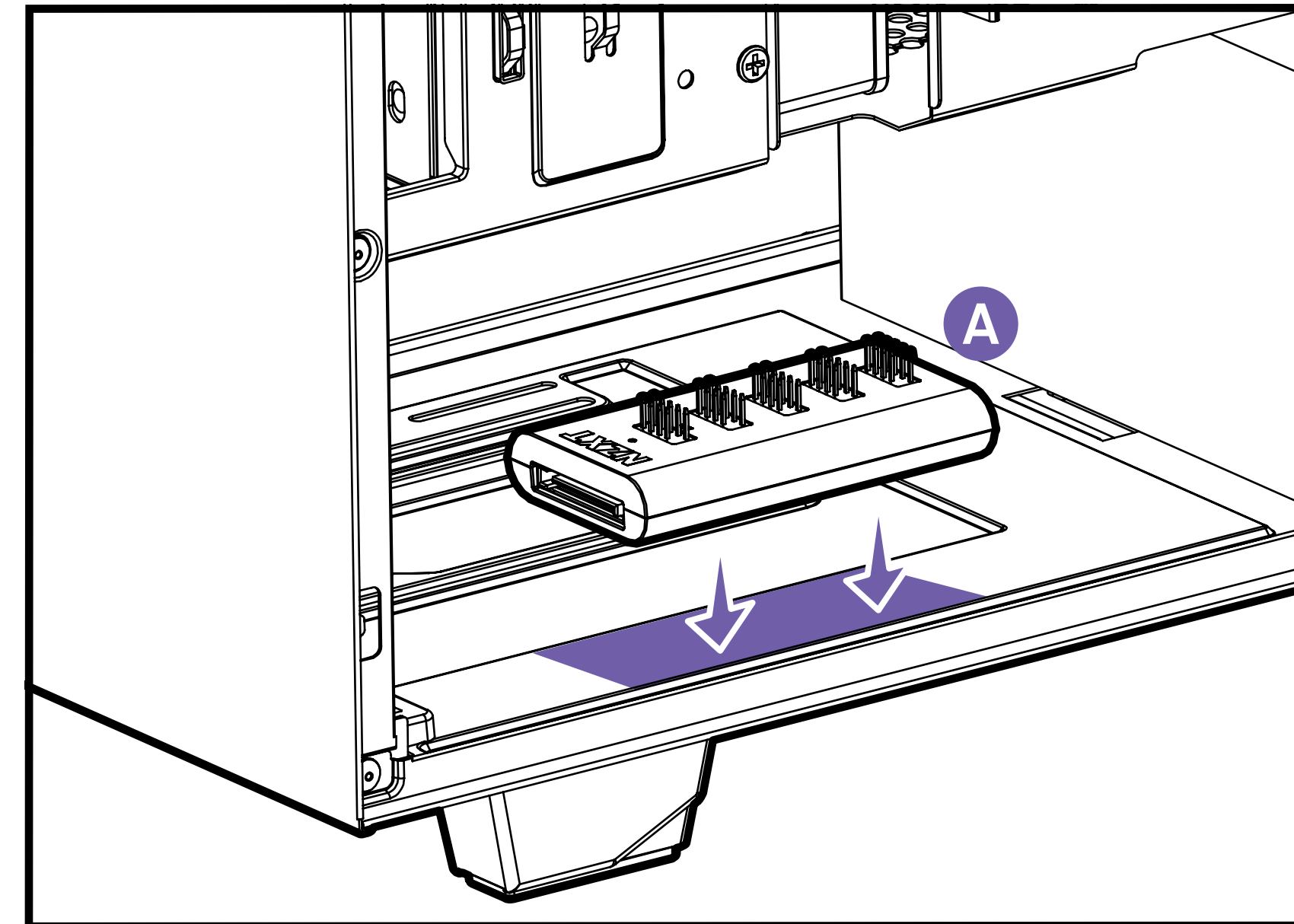

## 3.2 安裝



確認您的電腦已關閉電源，並使用 SATA 電源線將 Internal USB Hub 連接到電源供應器。

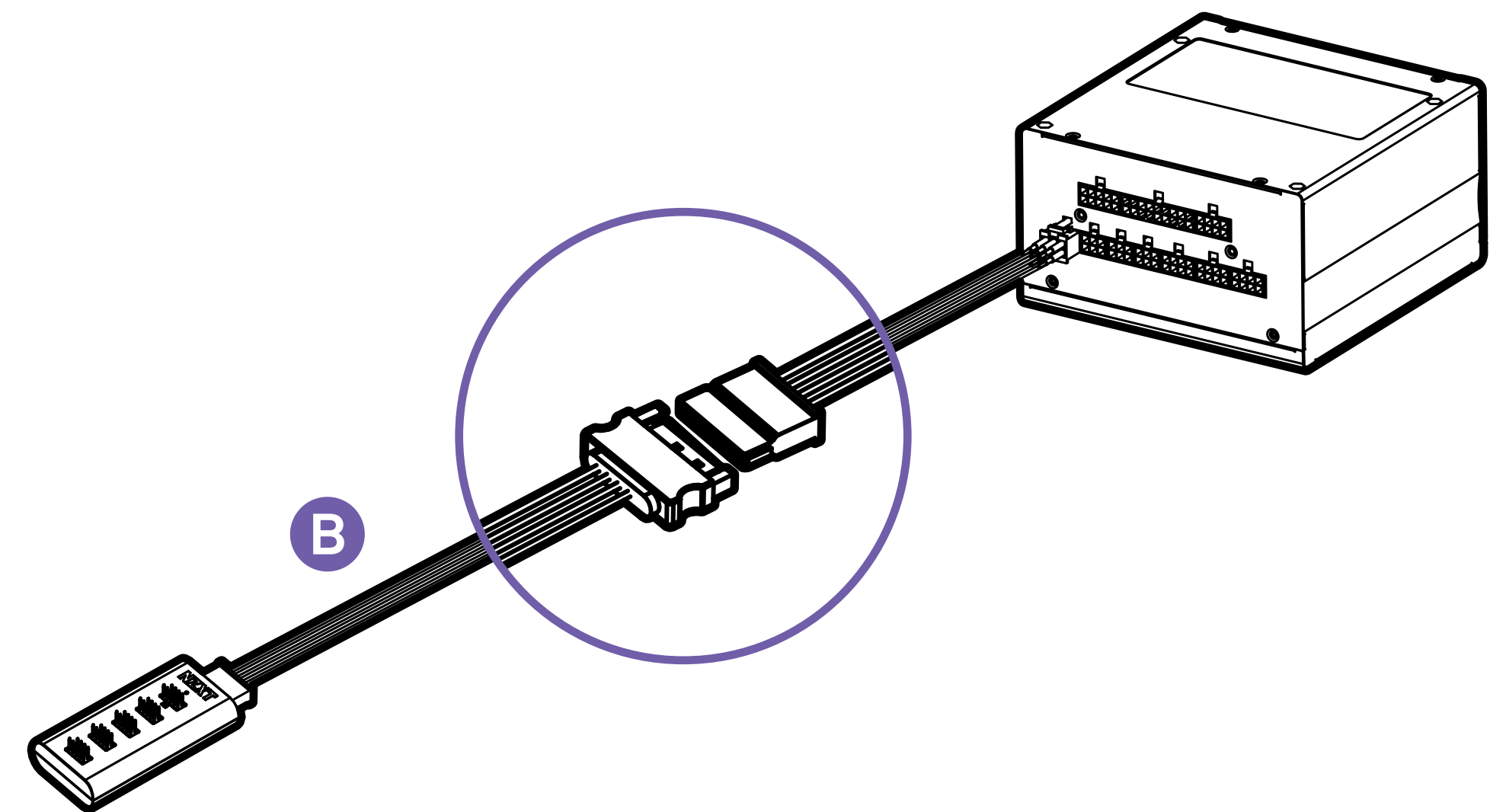

## 3.3 安裝



將 USB 連接線連接到集線器上的主機板接頭 (LED 指示燈下方第一個) , 並將另一端連接到主機板的 USB 2.0 接頭。確認 USB 接頭牢固連接。

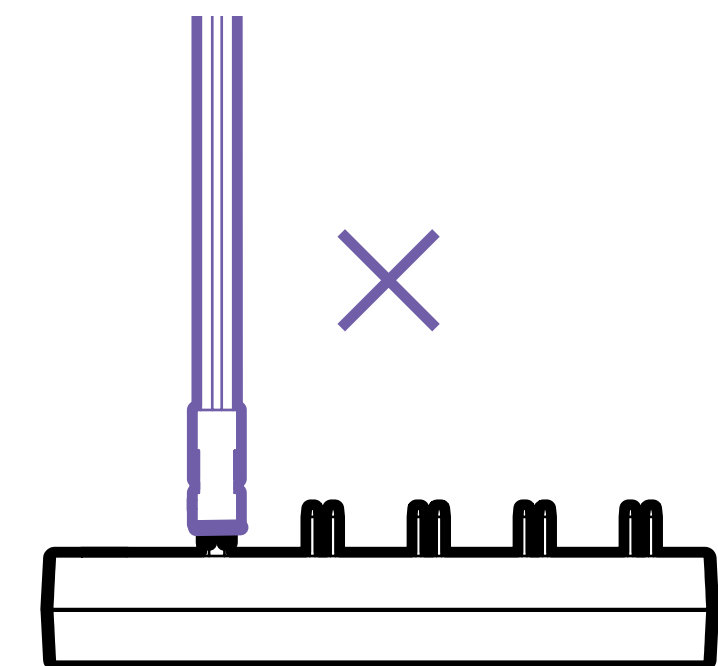
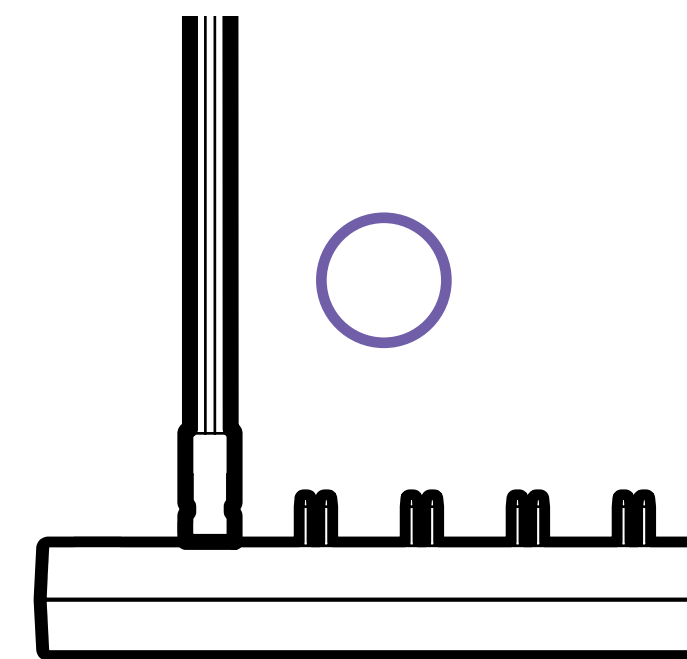
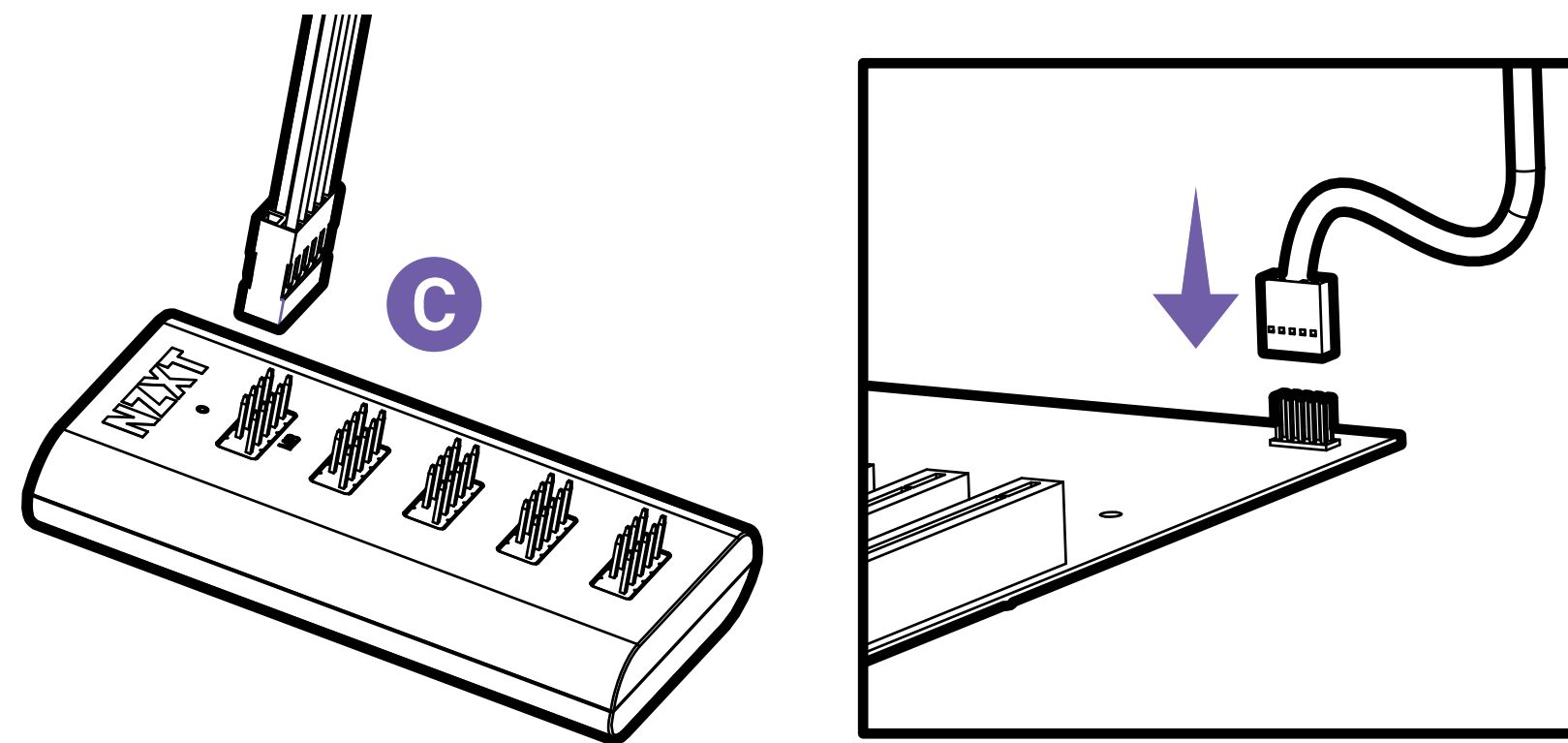

## 3.4 安裝



將 USB 裝置連接到其他內部接頭。

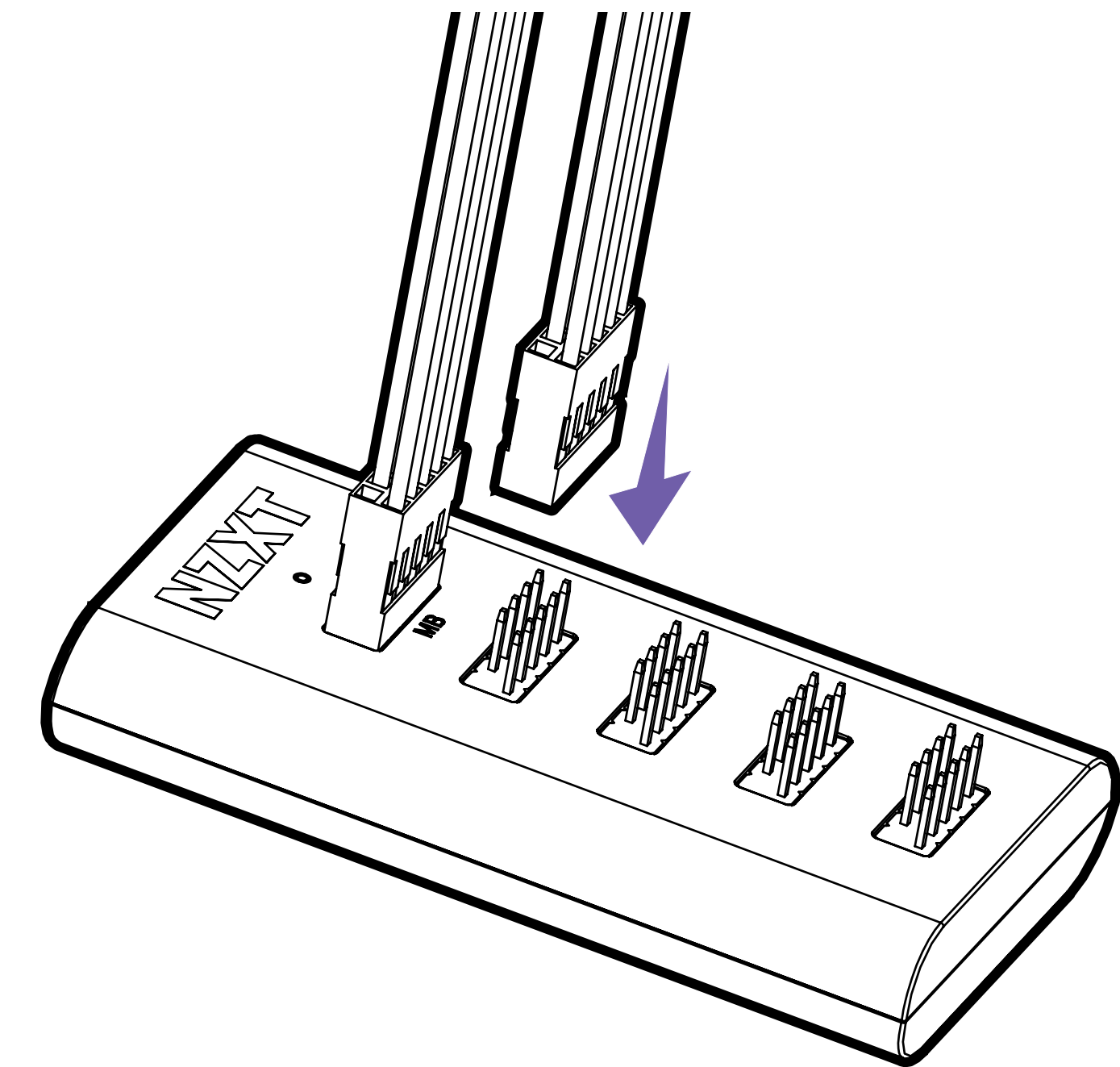





## 1. 問題：我的 Internal USB Hub 指示燈未亮起。

- a. 請確認 USB 連接線已確實連接到 Internal USB Hub 和主機板上的內部 USB 2.0 接頭。
- b. 請確認 SATA 電源線已確實連接到 Internal USB Hub 和電源供應器。
- c. 如果步驟 (a) 和 (b) 無法解決問題，請向購買 Internal USB Hub 的零售商或分銷商申請 RMA。

## 2. 問題：如何知道 Internal USB Hub 已被系統偵測到，且準備開始運作？

- a. Internal USB Hub 是 USB 裝置，若成功連接，在 NZXT CAM 中將顯示出「Internal USB Hub 裝置」。
- b. Internal USB Hub 是 USB 裝置，若成功連接，在 Windows 裝置管理員中也將顯示出「NZXT Internal USB Hub」。
- c. 如果在 NZXT CAM 或 Windows 裝置管理員中找不到 Internal USB Hub，請關閉電腦電源後，嘗試重新連接 USB 連接線。在裝置管理員中按下「掃描硬體變更」後，您應該可以在裝置管理員的「通用序列匯流排控制器」下看見該匯流排。



5.1 NZXT Global Warranty Policy.....A-2

5.2 Support and Service.....A-8

5.3 Regulatory Notices.....A-11

5.4 限用物质及元素列表/限用物質及元素清單 .....A-12

# 5.1 NZXT GLOBAL WARRANTY POLICY

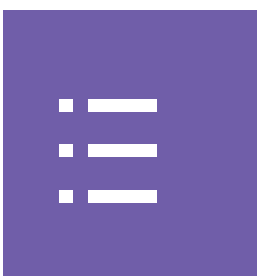

This NZXT Global Warranty Policy governs the sale of products by NZXT to you.

## I. WARRANTY LENGTH

Any replacement product will be covered under warranty for the remainder of the warranty period or thirty days, whichever is longer. Proof of purchase is required for warranty service.

## II. WHO IS PROTECTED

The Warranty covers only NZXT products purchased by the original consumer.

NEW NZXT PRODUCT	WARRANTY LENGTH FOR PARTS
Computer Cases	2 Years
Temperature Meters	2 Years
Fans	2 Years
Lighting	2 Years
Accessories	2 Years
Kraken M Coolers	3 Years
Headset/Headphone	2 Years
Headset/Headphone Storage	2 Years
Mixer	2 Years
Motherboards	3 Years
Power Supply	10 Years
Kraken X/Z Coolers	6 Years
Mini ITX Case with PSU, AIO, and Riser Card	3-year warranty on case, riser card, and AIO. 10-year warranty on PSU.
REFURBISHED NZXT PRODUCT	WARRANTY LENGTH FOR PARTS
All NZXT Certified Refurbished Products	1 Years



### III. WHAT IS AND IS NOT COVERED

Please note that our warranty is not an unconditional guarantee. If the product, in NZXT's reasonable opinion, malfunctions within the warranty period, NZXT will provide you at its sole discretion with a repaired or replacement product, either new or refurbished, with a similar function that is equal or greater in value depending on supply.

Our warranty does not cover the following:

- a. any product or serial number/warranty sticker modification applied without permission from NZXT;
- b. any damage that is not a manufacturing defect;
- c. damage, deterioration or malfunction resulting from: accident, abuse, misuse, neglect, fire, water, lightning, or other acts of nature, unauthorized product modification or failure to follow instructions included with the product;
- d. improper installation, unauthorized alterations or modifications, or repair or attempted repair by anyone not authorized by NZXT;
- e. shipping or transport damage (claims must be made with the carrier);
- f. normal wear and tear.

NZXT does not warrant that this product will meet your requirements. It is your responsibility to determine the suitability of this product for your purpose. For NZXT Store orders, we cover two way return shipping for all exchanges and returns. For all other authorized dealers, NZXT Support does not cover return shipping and only covers one way shipping from NZXT back to the end user for exchanges. Two way expedited shipping is provided for all PSUs covered under the Less Than Three program, indiscriminate of purchase location, provided the location is an approved NZXT reseller.

### IV. EXCLUSION OF DAMAGES (DISCLAIMER)

NZXT's sole obligation and liability under this warranty is limited to the repair or replacement of a defective product with either a new or refurbished product with a similar function that is equal or greater in value at our option. NZXT shall not, in any event, be liable for any incidental or consequential damage, including but not limited to damages resulting from interruption of service and loss of data, business, or for liability in tort relating to this product or resulting from its use or possession.



### V. LIMITATIONS OF IMPLIED WARRANTIES

Here are no other warranties, expressed or implied, including but not limited to those of merchantability or fitness for a particular purpose. The duration of implied warranties is limited to the warranty length specified in Paragraph I.

### VI. TO OBTAIN TECHNICAL SUPPORT

If you have already referenced your product owner's manual and still need help, you may contact us by phone at +1 (800) 228-9395, by email at [service@nzxt.com](mailto:service@nzxt.com), or visit the NZXT Support site at [nzxt.com/customer-support](https://nzxt.com/customer-support).

### VII. HOW TO OBTAIN A WARRANTY SERVICE FROM NZXT

To receive a warranty service for your product when purchased directly from NZXT, you must submit a request via the NZXT Support site outlining the problem. If a technician deems the product defective or requiring testing, you will be required to provide a copy of your proof of purchase, which will enable you to submit a Return Merchandise Authorization "RMA" request.

Once approved, you'll receive an RMA number, upon which you will be asked to ship the defective item back to NZXT with the RMA number clearly marked or labelled on the package. NZXT recommends that appropriate measures are taken to safeguard the product from damage during shipping.



### VIII. APPLICABLE LAW AND ADDITIONAL LEGAL RIGHTS FOR CONSUMERS

This warranty gives you specific legal rights. These conditions are governed and construed in accordance with the laws of California (with exception of its conflict of law provisions), and the application of the United Nations Convention of Contracts for the International Sale of Goods is expressly excluded. The non-exclusive jurisdiction of the courts of California is agreed, which means that you may bring a claim to enforce your consumer protection rights in connection with this Global Warranty in the country which you have your habitual residence where you may have additional rights. These rights may vary.

For original consumers who are covered by consumer protection laws or regulations in their country, state, or province of purchase or, if different, their country, state, or province of residence, the benefits conferred by this warranty are in addition to all rights and remedies conveyed by such consumer protection laws and regulations. To the extent that liability under such consumer laws can be limited, NZXT's liability is limited, and its sole option, to repair or replacement, either new or refurbished, with a similar function that is equal or greater in value depending on supply.

#### In the United Kingdom:

- a. For NZXT products sold to customers in the UK, during the expected lifespan of your product your legal rights entitle you to the following:
  - > Up to 30 days: if your goods are faulty, then you can get an immediate refund.
  - > Up to six months: if your goods can't be repaired or replaced, then you're entitled to a full refund, in most cases.
  - > Up to six years: if your goods do not last a reasonable length of time you may be entitled to some money back.
- b. If the person seeking to rely on the guarantee is not the original consumer, the NZXT Warranty will cover the product in relation to that person provided that they are able to provide proof of the transfer of the benefit of the guarantee from the original consumer.
- c. The implied warranties under the Consumer Rights Act 2015 says that your goods must be as described, fit for all purposes for which such goods are usually supplied, and of satisfactory quality.

#### In the EU:

- d. If you are a consumer and have your habitual residence in the EU, you additionally enjoy the protection afforded to you by provisions that cannot be derogated from by agreement by virtue of the law where you have your habitual residence.



### IX. WARRANTY SERVICE FROM RESELLERS

In the event that a warranty service is sought, you must provide proof of purchase (store receipt or invoice) in order to receive the service and if deemed necessary, repair or replacement product.

#### **In North America:**

Within the first 60 days after purchase, please return your product (or for power supplies installed within our enclosures, just the failed power supply) to your dealer or reseller for a replacement. If the product is still within warranty and you can no longer return it to your dealer, please contact NZXT Customer Support (see above) for assistance and instructions. NZXT will not accept returns without prior approval and an RMA number.

#### **In Europe:**

Within the first year after purchase, please return your product (or for power supplies installed within our enclosures, just the failed power supply) to your dealer or reseller for a replacement. If the product is still within warranty and you can no longer return it to your dealer, please contact NZXT Customer Support (see above) for assistance and instructions. NZXT will not accept returns without prior approval.

#### **In Australasia:**

Within the first two years after purchase, please return your product (or for power supplies installed within our enclosures, just the failed power supply) to your dealer or reseller for a replacement. If the product is still within warranty and you can no longer return it to your dealer, please contact NZXT Customer Support (see above) for assistance and instructions. NZXT will not accept returns without prior approval.

The cost of shipping will be borne at the first instance by you; however, if the purchased item is defective, NZXT will reimburse reasonable postage or transportation of costs.

#### **Outside North America, Europe, and Australasia:**

If your product needs to be returned within the warranty period, please contact the retailer or distributor from whom you purchased the product.



### X. NZXT.COM STORE RETURNS/EXCHANGE POLICY

Eligible products under this NZXT Warranty qualify for a full refund or exchange only with an authorized RMA number and if the item is returned to the NZXT.com store inventory within 30 days of purchase. Returns are not allowed beyond 30 days of the purchase date. The NZXT.com Store reserves the right to deny any return or exchange. Refunds will be credited to the original method of payment. To initiate a return, simply submit a request via NZXT support site.

- > Visit [nzxt.com/warranty](https://nzxt.com/warranty) and [support.nzxt.com](https://support.nzxt.com) for information on warranty coverage and service.
- > Visite el sitio Web [nzxt.com/warranty](https://nzxt.com/warranty) y [support.nzxt.com](https://support.nzxt.com) para obtener información sobre la cobertura y el servicio de la garantía.
- > Visitez [nzxt.com/warranty](https://nzxt.com/warranty) et [support.nzxt.com](https://support.nzxt.com) pour les informations de la couverture de la garantie et du service.
- > Informationen zu Geltungsbereich und Service der Garantie finden Sie unter [support.nzxt.com](https://support.nzxt.com) und [nzxt.com/warranty](https://nzxt.com/warranty).
- > Visitare il sito [nzxt.com/warranty](https://nzxt.com/warranty) e [support.nzxt.com](https://support.nzxt.com) per informazioni sulla copertura e sul servizio della garanzia.
- > Visite [nzxt.com/warranty](https://nzxt.com/warranty) e [support.nzxt.com](https://support.nzxt.com) para obter informações sobre a cobertura da garantia e assistência.
- > Подробную информацию об условиях гарантийного обслуживания см. на веб-сайте [nzxt.com/warranty](https://nzxt.com/warranty) и [support.nzxt.com](https://support.nzxt.com).
- > 제품 보증 범위와 서비스 정보를 확인하시려면 [nzxt.com/warranty](https://nzxt.com/warranty) 또는 [support.nzxt.com](https://support.nzxt.com) 을 방문해 주시기 바랍니다.
- > 保証範囲およびサービスに関する情報については、[support.nzxt.com](https://support.nzxt.com) と [nzxt.com/warranty](https://nzxt.com/warranty) にアクセスしてください。
- > 请造访 [nzxt.com/warranty](https://nzxt.com/warranty) 和 [support.nzxt.com](https://support.nzxt.com) 了解保修范围和服务的信息。
- > 請訪問 [nzxt.com/warranty](https://nzxt.com/warranty) 和 [support.nzxt.com](https://support.nzxt.com) 了解產品保固範圍和更多服務訊息。

**NZXT, Inc./** 15736 E Valley Blvd, City of Industry, CA 91744, USA  
**NZXT Europe GmbH/** Industriering Ost 66 | 47906 Kempen | Germany  
+1 (800) 228-9395 / [service@nzxt.com](mailto:service@nzxt.com) / [NZXT.com](https://nzxt.com)





### SUPPORT AND SERVICE

If you have any questions or problems with the NZXT product you purchased, please don't hesitate to contact us using our support system. [support.nzxt.com](https://support.nzxt.com)

Please include a detailed explanation of your problem and your proof of purchase. For comments and suggestions, you can e-mail our design team, [designer@nzxt.com](mailto:designer@nzxt.com). Lastly we would like to thank you for your support by purchasing this product.

For more information about NZXT, please visit us online. NZXT Website: [NZXT.com](https://nzxt.com)

### SOPORTE Y SERVICIO

Si tiene preguntas o problemas con el producto NZXT que usted compró, no dude en ponerse en contacto con [service@nzxt.com](mailto:service@nzxt.com) y suministrar una explicación detallada de su problema así como su prueba de compra.

Puede hacer consultas sobre piezas de repuesto en [support.nzxt.com](https://support.nzxt.com).

Para comentarios y sugerencias, escriba un mensaje de correo electrónico a nuestro equipo de diseño: [designer@nzxt.com](mailto:designer@nzxt.com). Gracias por comprar un producto NZXT. Para más información acerca de NZXT, visítenos en línea. Página web de NZXT: [NZXT.com](https://nzxt.com)

### SUPPORT ET SERVICE

Si vous avez des questions ou des problèmes avec le produit NZXT que vous avez acheté, n'hésitez pas à contacter [service@nzxt.com](mailto:service@nzxt.com) avec une description détaillée de votre problème et votre preuve d'achat. Vous pouvez aussi commander des pièces de remplacement auprès [support.nzxt.com](https://support.nzxt.com). Pour les commentaires et les suggestions, envoyez un email à notre équipe de design, [designer@nzxt.com](mailto:designer@nzxt.com).

Merci d'avoir acheté ce produit de NZXT. Pour plus d'informations sur NZXT, visitez notre site Web. Site Web de NZXT : [NZXT.com](https://nzxt.com)

### KUNDENDIENST UND SERVICE

Falls Fragen oder Probleme bezüglich Ihres NZXT-Produktes auftreten, wenden Sie sich bitte mit einer detaillierten Problembeschreibung und Ihrem Kaufbeleg an [service@nzxt.com](mailto:service@nzxt.com). Ersatzteile können Sie unter [support.nzxt.com](https://support.nzxt.com) anfragen.

Kommentare und Anregungen senden Sie bitte per [designer@nzxt.com](mailto:designer@nzxt.com) an unser Designteam. Vielen Dank, dass Sie ein NZXT-Produkt erworben haben. Weitere Informationen über NZXT erhalten Sie im Internet. NZXT-Webseite: [NZXT.com](https://nzxt.com)



### ASSISTENZA E SERVIZIO

In caso di dubbi o problemi con il prodotto NZXT acquistato, non esitate a contattarci utilizzando il nostro sistema di assistenza. [support.nzxt.com](mailto:support.nzxt.com) Includere una spiegazione dettagliata del problema e la prova di acquisto. Per commenti e suggerimenti, siete pregati di inviare un messaggio al nostro team di progettisti, all'indirizzo: [designer@nzxt.com](mailto:designer@nzxt.com). Infine, vogliamo ringraziarvi del vostro supporto con l'acquisto di questo prodotto. Per altre informazioni su NZXT, visitate il nostro sito. Sito NZXT: [NZXT.com](http://NZXT.com)

### ASSISTÊNCIA E MANUTENÇÃO

Caso tenha questões ou problemas com o produto NZXT adquirido, não hesite em contactar-nos através do endereço [service@nzxt.com](mailto:service@nzxt.com) fornecendo a explicação detalhada do seu problema e a prova de compra. Poderá solicitar peças de substituição através do endereço [support.nzxt.com](mailto:support.nzxt.com). Para comentários e sugestões, contacte a nossa equipa de design através do endereço de e-mail, [designer@nzxt.com](mailto:designer@nzxt.com). Obrigado por ter adquirido um produto NZXT. Para mais informações acerca da NZXT, visite-nos online. Web site da NZXT: [NZXT.com](http://NZXT.com)

### СЛУЖБА ПОДДЕРЖКИ И ОБСЛУЖИВАНИЯ

В случае возникновения вопросов или неисправностей в приобретенных вами продуктах NZXT обращайтесь по адресу: [service@nzxt.com](mailto:service@nzxt.com) с подробным описанием проблемы и подтверждением покупки. О наличии запчастей можно узнать, обратившись по адресу: [support.nzxt.com](mailto:support.nzxt.com). Замечания и предложения отправляйте в адрес нашей группы разработчиков: [designer@nzxt.com](mailto:designer@nzxt.com). Благодарим вас за покупку продукта NZXT. Более подробная информация о компании NZXT представлена на наших веб-сайтах. Веб-сайт NZXT: [NZXT.com](http://NZXT.com)



### 지원 및 서비스

구입한 NZXT 제품과 관련하여 질문 또는 문제가 있을 경우, 당사의 지원 시스템 ([support.nzxt.com](http://support.nzxt.com))을 사용하여 문의하십시오. 문제를 자세히 기술하고 구매 증빙을 제출하십시오. 의견 또는 제안 사항이 있을 경우 당사 설계 팀에 [designer@nzxt.com](mailto:designer@nzxt.com)으로 이메일을 보내십시오. 마지막으로 이 제품을 구입하여 당사를 응원해 주셔서 감사합니다. NZXT에 대해 자세히 알려면 온라인으로 방문하십시오. NZXT 웹사이트: [NZXT.com](http://NZXT.com)

### サポートおよびサービス

購入されましたNZXTの製品に関するご質問または問題は、問題の詳細および購入の証明を添えて、ご遠慮なく[service@nzxt.com](mailto:service@nzxt.com)までご連絡ください。交換部品は[support.nzxt.com](http://support.nzxt.com)までお尋ねください。ご意見およびご提案は弊社設計チーム、[designer@nzxt.com](mailto:designer@nzxt.com)までメールを送信してください。NZXT製品をご購入いただきましてありがとうございます。NZXTに関する詳細は、インターネット上のウェブサイトをご覧ください。NZXT ウェブサイト: [NZXT.com](http://NZXT.com)

### 支持和服务

如果有任何疑问或者在使用 NZXT 产品的过程中遇到任何问题,欢迎联络 [service@nzxt.com](mailto:service@nzxt.com),联络时请提供关于问题的详细说明及购买凭证。您可以向 [support.nzxt.com](http://support.nzxt.com) 查询更换部件。如有任何意见或建议,欢迎致信我们的设计团队,电子邮件地址是 [designer@nzxt.com](mailto:designer@nzxt.com)。感谢您购买 NZXT 产品。有关 NZXT 的更多信息,请造访我们的在线网站。NZXT 网站: [NZXT.com](http://NZXT.com)

### 支援和服務

如果在使用NZXT 產品的過程中有遇到任何問題或疑問，歡迎聯繫 [service@nzxt.com](mailto:service@nzxt.com)，並請提供問題的詳細敘述及購買證明。您可以透過 [support.nzxt.com](http://support.nzxt.com) 查詢更換部件。如有任何意見或建議，歡迎來信與設計團隊聯繫 [designer@nzxt.com](mailto:designer@nzxt.com)。最後，感謝您購買 NZXT 產品。有關 NZXT 的更多信息，請訪問我們的網站。NZXT 網站: [NZXT.com](http://NZXT.com)



### Federal Communications Commission (FCC) Notice

This device complies with Part 15 of the FCC rules. Operation is subject to the following two conditions: (1) this device may not cause harmful interference, and (2) this device must accept any interference received, including interference that may cause undesired operation.

**NOTE:** This equipment has been tested and found to comply with the limits for a class A digital device, pursuant to Part 15 of the FCC rules. These limits are designed to provide reasonable protection against harmful interference when the equipment is operated in a commercial environment. This equipment uses, generates, and can radiate radio frequency energy and if not installed in accordance with the operator's manual, may cause harmful interference to radio communications. Operation of this equipment in a residential area is likely to cause interference in which case the user will be required to correct the interference at his own expense.

**WARNING:** Changes or modifications made to this device which are not expressly approved by the party responsible for compliance could void the user's authority to operate the equipment.

This Class B digital apparatus complies with Canadian ICES-003.

Cet appareil numérique de la classe [B] est conforme à la norme NMB-003 du Canada.

This device complies with Part 15 of the FCC Rules. Operation is subject to the following two conditions:

(1) This device may not cause harmful interference, and (2) this device must accept any interference received, including interference that may cause undesired operation. CAN ICES-3 (B) / NMB-3 (B)

이 기기는 가정용 (B급) 전자파적합기기로서 주로 가정에서 사용하는 것을 목적으로 하며, 모든 지역에서 사용할 수 있습니다.

この装置は、クラスB情報技術装置です。この装置は、家庭環境で使用することを目的としていますが、この装置がラジオやテレビジョン受信機に近接して使用されると、受信障害を引き起こすことがあります。

取扱説明書に従って正しい取り扱いをして下さい。 VCCI-B

## 5.4 限用物质及元素列表/限用物質及元素清單

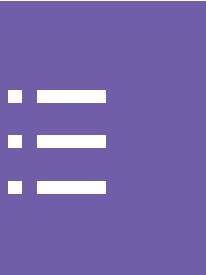

### ROHS COMPLIANCE

产品名称：Internal USB Hub (型号：AC-IUSBH-M3)

有害物质

部件名称	铅(Pb)	镉(Cd)	汞(Hg)	六价铬(Cr <sup>6+</sup> )	多溴联苯(PBB)	多溴联苯醚(PBDE)
线材	○	○	○	○	○	○
塑胶	○	○	○	○	○	○
五金	○	○	○	○	○	○
PCBA	X	○	○	○	○	○
配件	○	○	○	○	○	○

本表格依据SJ/T 11364的规定编制。

○: 表示该有害物质在该部件所有均质材料中的含量均在 GB/T 26572 规定的限量要求以下。

X: 表示该有害物质至少在该部件的某一均质材料中的含量超出GB/T 26572官定的限量要求。

说明：电路板：单板/电路模块上电子元器件的陶瓷或玻璃中含铅。

產品名稱：Internal USB Hub (型號：AC-IUSBH-M3)

限用物質及其化學符號

單元	鉛(Pb)	鎘(Cd)	汞(Hg)	六價鉻(Cr <sup>6+</sup> )	多溴聯苯(PBB)	多溴聯苯醚(PBDE)
線材	○	○	○	○	○	○
塑膠	○	○	○	○	○	○
五金	○	○	○	○	○	○
PCBA	—	○	○	○	○	○
配件	○	○	○	○	○	○

備考1. “超出0.1wt%”及“超出0.01wt%”係指限用物質之百分比含量超出百分比含量基準值。

備考2. “○”係指該項限用物質之百分比含量未超出百分比含量基準值。

備考3. “—”係指該項限用物質為排除項目。