

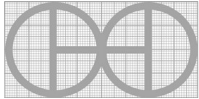

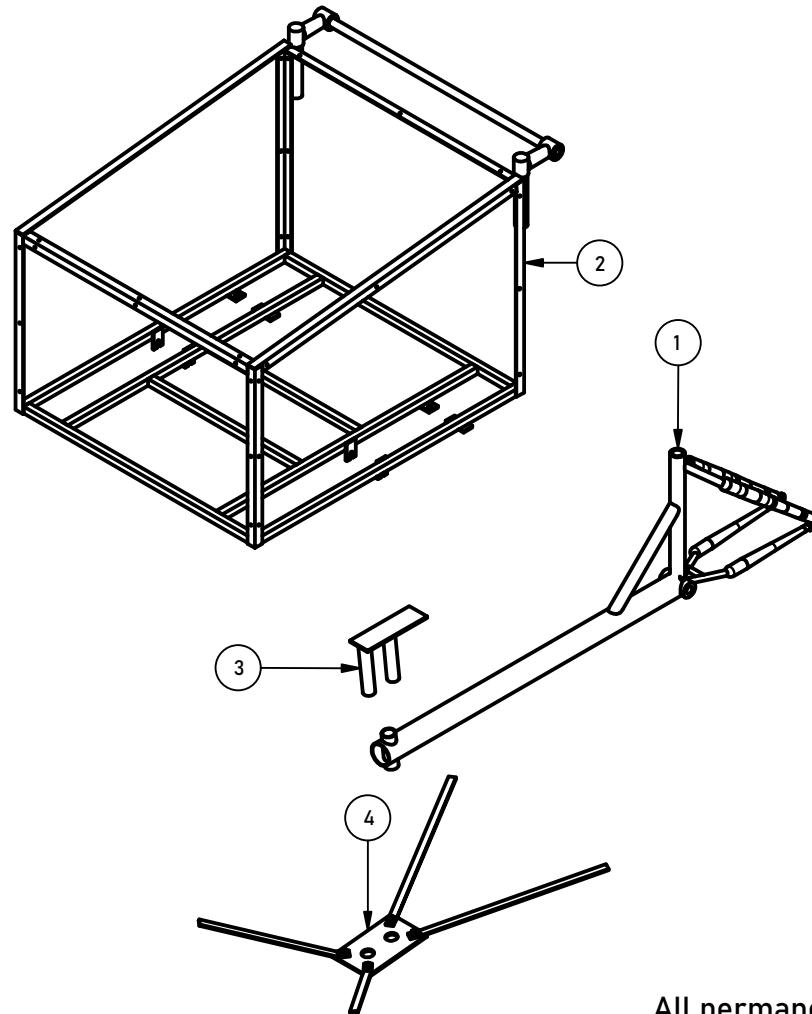

PROJECT TRICYCLE CARGO BIKE		CREATED BY A. PARDO		APPROVED BY D. Jaeger	
PART NAME tricycle cargo bike B		PART CODE A1		DOCUMENT TYPE ASSEMBLY	
 		LICENSE CC-BY-SA 4.0		FILE NAME tricycle cargo bike B.iam	
		SCALE 1/15		VERSION 1.0	
		SHEET 1		QUANTITY 1	
		DATE 12/1/2021			



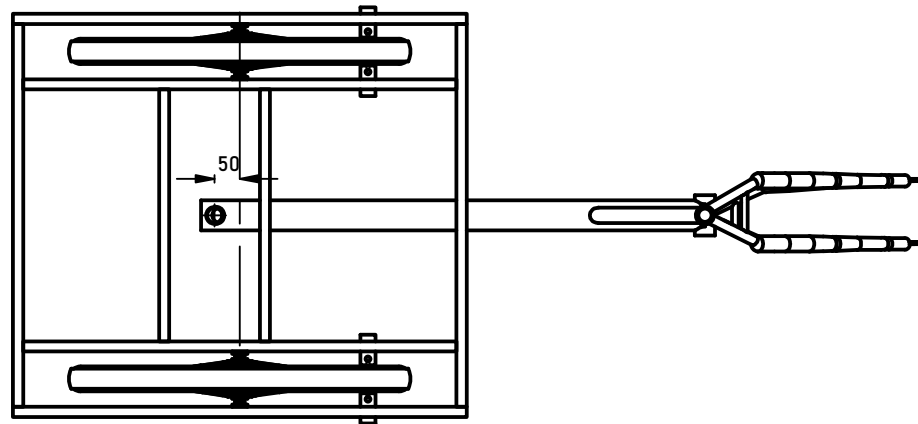
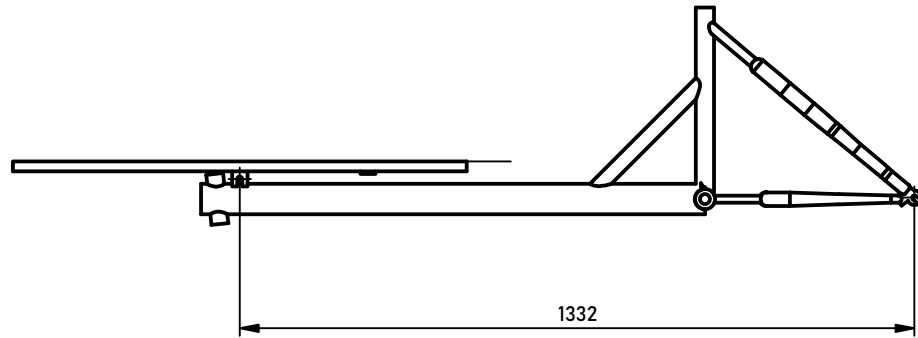

All permanent connections between parts are welded, bolted connections are indicated on the drawings.

PROJECT TRICYCLE CARGO BIKE	CREATED BY A. PARDO	APPROVED BY D. Jaeger		
PART NAME tricycle cargo bike B	PART CODE A2	DOCUMENT TYPE ASSEMBLY	MATERIAL	
 	LICENSE CC-BY-SA 4.0	FILE NAME tricycle cargo bike B.iam	VERSION 1.0	QUANTITY
		SCALE 1 / 18	SHEET 2	DATE 12/1/2021



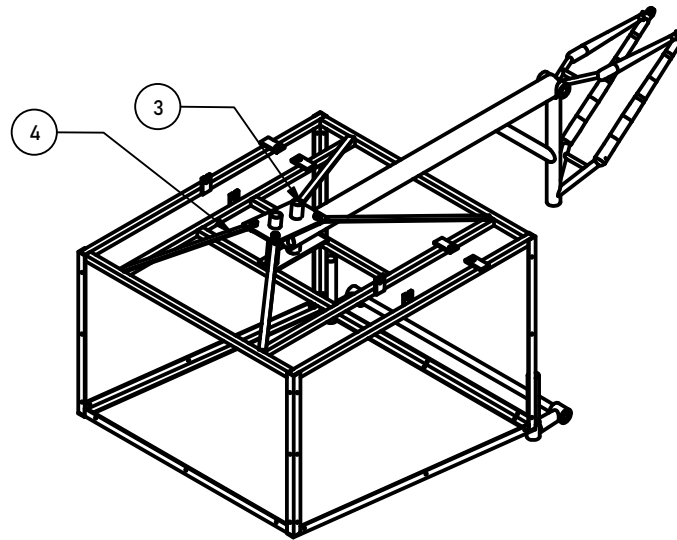
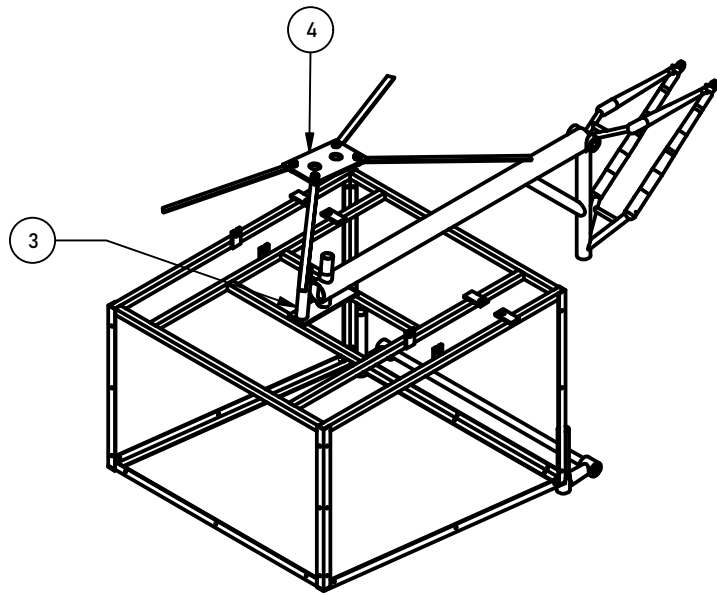

PROJECT TRICYCLE CARGO BIKE		CREATED BY A. PARDO		APPROVED BY D. Jaeger	
PART NAME tricycle cargo bike B		PART CODE A3		DOCUMENT TYPE ASSEMBLY	
 		LICENSE CC-BY-SA 4.0		FILE NAME tricycle cargo bike B.iam	
		SCALE 1 / 15		VERSION 1.0	
				QUANTITY	
				SHEET 3	
				DATE 12/1/2021	





PROJECT TRICYCLE CARGO BIKE	CREATED BY A. PARDO	APPROVED BY D. Jaeger		
PART NAME tricycle cargo bike B	PART CODE A4	DOCUMENT TYPE ASSEMBLY	MATERIAL	
 	LICENSE CC-BY-SA 4.0	FILE NAME tricycle cargo bike B.iam	VERSION 1.0	QUANTITY
		SCALE 1 / 20	SHEET 4	DATE 12/1/2021

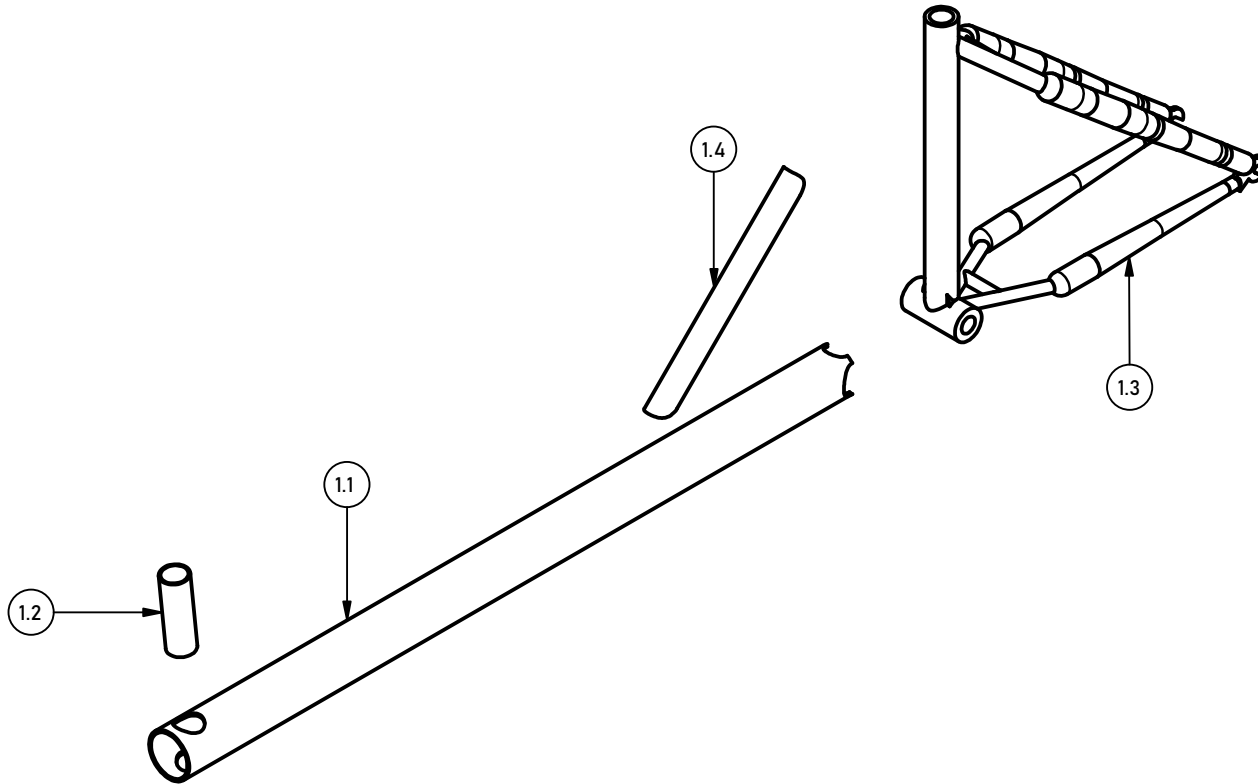

PARTS LIST							
POS.	POS. OLD	QTY	PART NUMBER	FILE NAME	PART TYPE	SPECIFICATION	SHEET
A1		1	tricycle cargo bike B	tricycle cargo bike B.iam			1
A2		1	tricycle cargo bike B	tricycle cargo bike B.iam			2
A3		1	tricycle cargo bike B	tricycle cargo bike B.iam			3
A4		1	tricycle cargo bike B	tricycle cargo bike B.iam			4
B1		1	parts-tricycle cargo bike B	parts-tricycle cargo bike B.iam			5
1		1	Assembly1-tricycle cargo bike B	Assembly1-tricycle cargo bike B.iam			6
1.1	1	1	wl_lacb_1.1_Down-tube	wl_lacb_1.1_Down-tube.ipt	Production	A36	7
1.2	2	1	wl_lacb_1.2_Head-tube	wl_lacb_1.2_Head-tube.ipt	Production	A36	8
1.3	3	1	wl_lacb_1.3_Angle-profile-box		Standard	26 inch size	
1.4	2	1	wl_lacb_1.4_Reinforcement-pipe		Standard		
2		1	Assembly2-tricycle cargo bike B	Assembly2-tricycle cargo bike B.iam			
2.1		1	Assembly2-tricycle cargo bike B	Assembly2-tricycle cargo bike B.iam			10
2.2	9	2	wl_lacb_2.2_Parts-box-bottom	wl_lacb_2.2_Parts-box-bottom.ipt	Production	A36	11
2.3	10	4	wl_lacb_2.3_Wheel-mount	wl_lacb_2.3_Wheel-mount.ipt	Production	A36	12
2.4	11	4	wl_lacb_2.4_Brake-holder	wl_lacb_2.4_Brake-holder.ipt	Production	A36	13
2.5	13	2	wl_lacb_2.5_Angle-profile-box	wl_lacb_2.5_Angle-profile-box.ipt	Production	A36	14
2.6	14	2	wl_lacb_2.6_Stem-mounting	wl_lacb_2.6_Stem-mounting.ipt	Standard		
2.7	15	1	wl_lacb_2.7_Steering-handle	wl_lacb_2.7_Steering-handle.ipt	Production	A36	15
2.8	16	2	wl_lacb_2.8_Wall-plate-holder	wl_lacb_2.8_Wall-plate-holder.ipt	Production	A36	16
2.9	9	2	wl_lacb_2.9_Parts-box-bottom	wl_lacb_2.9_Parts-box-bottom.ipt	Production	A36	17
2.10	9	2	wl_lacb_2.10_Parts-box-bottom	wl_lacb_2.10_Parts-box-bottom .ipt	Production	A36	18
2.11	9	2	wl_lacb_2.11_Parts-box-bottom	wl_lacb_2.11_Parts-box-bottom.ipt	Production	A36	19
2.12	13	2	wl_lacb_2.12_Angle-profile-box	wl_lacb_2.12_Angle-profile-box.ipt	Production	A36	20
2.13	13	2	wl_lacb_2.13_Angle-profile-box	wl_lacb_2.13_Angle-profile-box.ipt	Production	A36	21
2.14	13	2	wl_lacb_2.14_Angle-profile-box	wl_lacb_2.14_Angle-profile-box.ipt	Production	A36	22
3		1	Assembly3-tricycle cargo bike B	Assembly3-tricycle cargo bike B.iam			23
3.1	5	1	wl_lacb_3.1_Head tube-plate	wl_lacb_3.1_Head tube-plate.ipt	Production	A36	24
3.2	3	1	wl_lacb_3.2_Handlebar		Standard		
3.3	4	1	wl_lacb_3.3_Security tube		Standard		
4		1	Assembly4-tricycle cargo bike B	Assembly4-tricycle cargo bike B.iam			25
4.1	8	1	wl_lacb_4.1_Security-plate	wl_lacb_4.1_Security-plate.ipt	Production	A36	26
4.2	12	2	wl_lacb_24.2_Strut	wl_lacb_4.2_Strut.ipt	Production	A36	27
4.3	12	2	wl_lacb_4.3_Strut	wl_lacb_4.3_Strut.ipt	Production	A36	28
4.4		4	ASME B18.21.2M - 10, LWSHSLW		Standard	ASME B18.21.2M - 10B	
4.5		4	ANSI B18.2.4.5M - M10 x 1.5		Standard	ANSI B18.2.4.5M - M10 x 1.5 - 16	
4.6		4	ANSI B18.2.3.5M - M10 x 1,5 x 20		Standard	ANSI B18.2.3.5M - M10 x 1,5 x 20	

PROJECT TRICYCLE CARGO BIKE		CREATED BY A. PARDO		APPROVED BY D. Jaeger	
PART NAME parts-tricycle cargo bike B		PART CODE B1		DOCUMENT TYPE PART LIST	
 		LICENSE CC-BY-SA 4.0		FILE NAME parts-tricycle cargo bike B.iam	
				VERSION 1.0	
		SCALE 1 / 50		SHEET 5	
				DATE 12/1/2021	



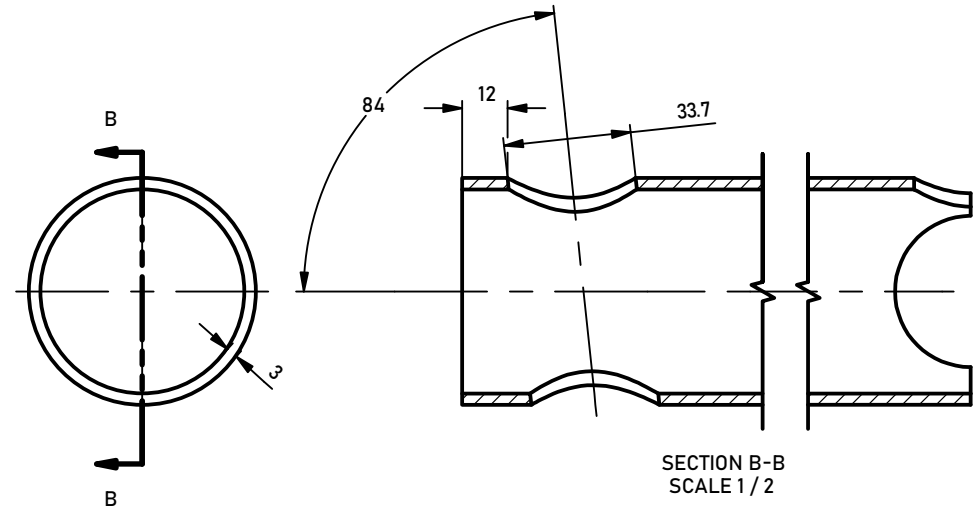
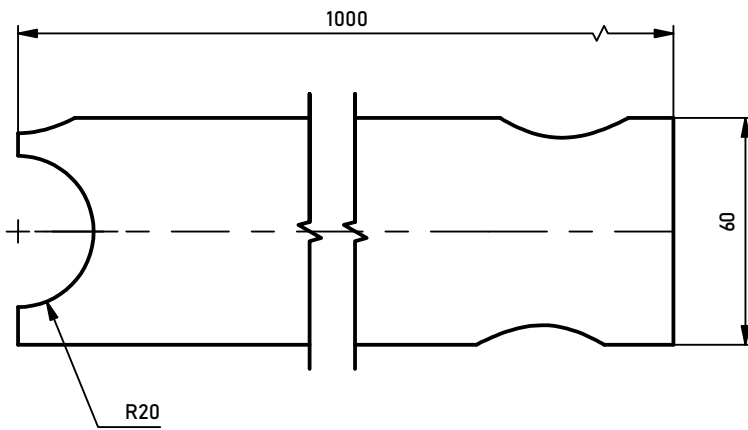
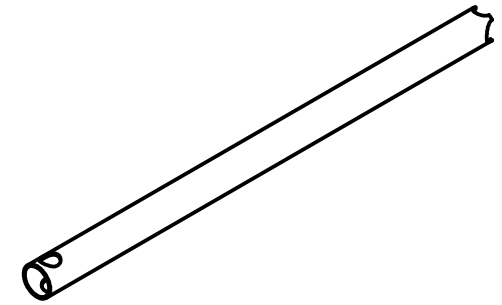
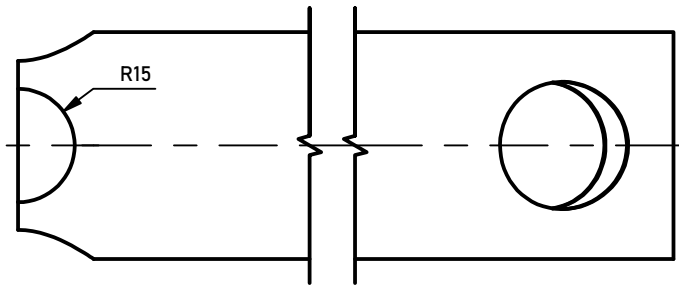

PROJECT TRICYCLE CARGO BIKE		CREATED BY A. PARDO		APPROVED BY D. Jaeger	
PART NAME Assembly1-tricycle cargo bike B		PART CODE 1.01		DOCUMENT TYPE	
 		LICENSE CC-BY-SA 4.0		FILE NAME Assembly1-tricycle cargo bike B.aml.0	
				SCALE 1 / 8	VERSION 4



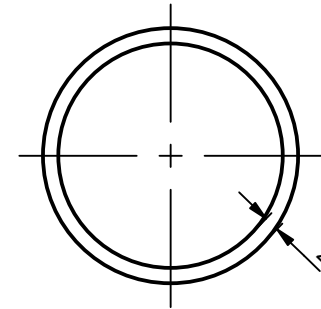
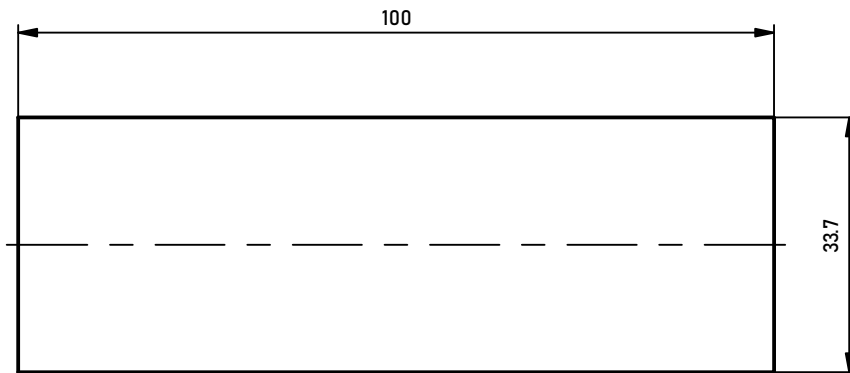
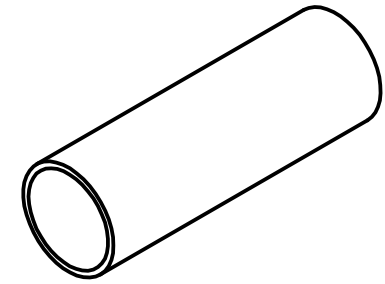

PROJECT TRICYCLE CARGO BIKE		CREATED BY A. PARDO		APPROVED BY D. Jaeger	
PART NAME wl_lacb_1.1_Down-tube		PART CODE 1.1		DOCUMENT TYPE Production	
 		LICENSE CC-BY-SA 4.0		MATERIAL A36	
		FILE NAME wl_lacb_1.1_Down-tube.ipt		VERSION 1.0	QUANTITY 1
		SCALE 1/2		SHEET 7	DATE 11/1/2021

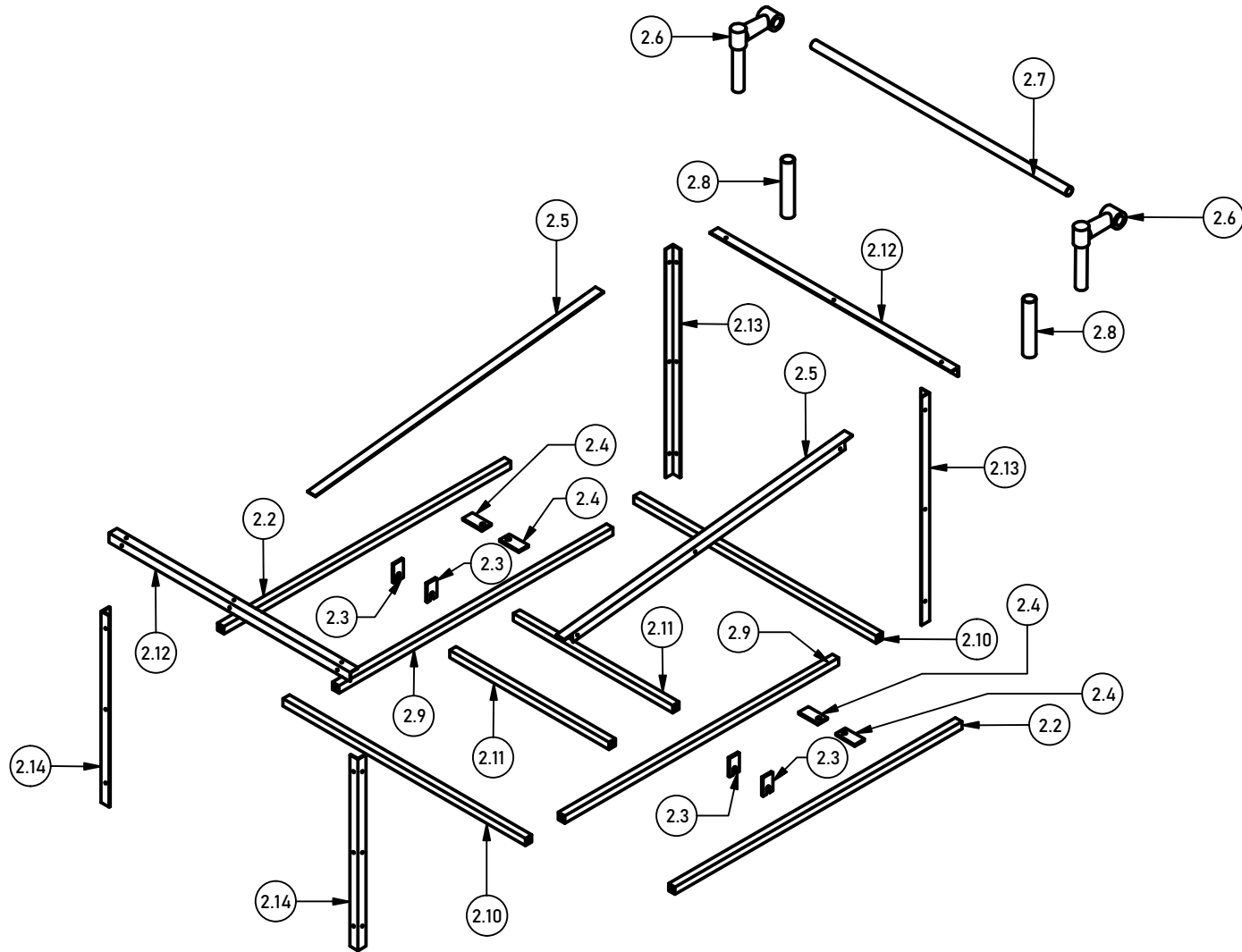

PROJECT TRICYCLE CARGO BIKE		CREATED BY A. PARDO		APPROVED BY D. Jaeger	
PART NAME wL_lacb_1.2_Head-tube		PART CODE 1.2		DOCUMENT TYPE Production	
 		LICENSE CC-BY-SA 4.0		FILE NAME wL_lacb_1.2_Head-tube.ipt	
				SCALE 1:1	
		MATERIAL A36		VERSION 1.0	
		SHEET 8		QUANTITY 1	
		DATE 11/1/2021			



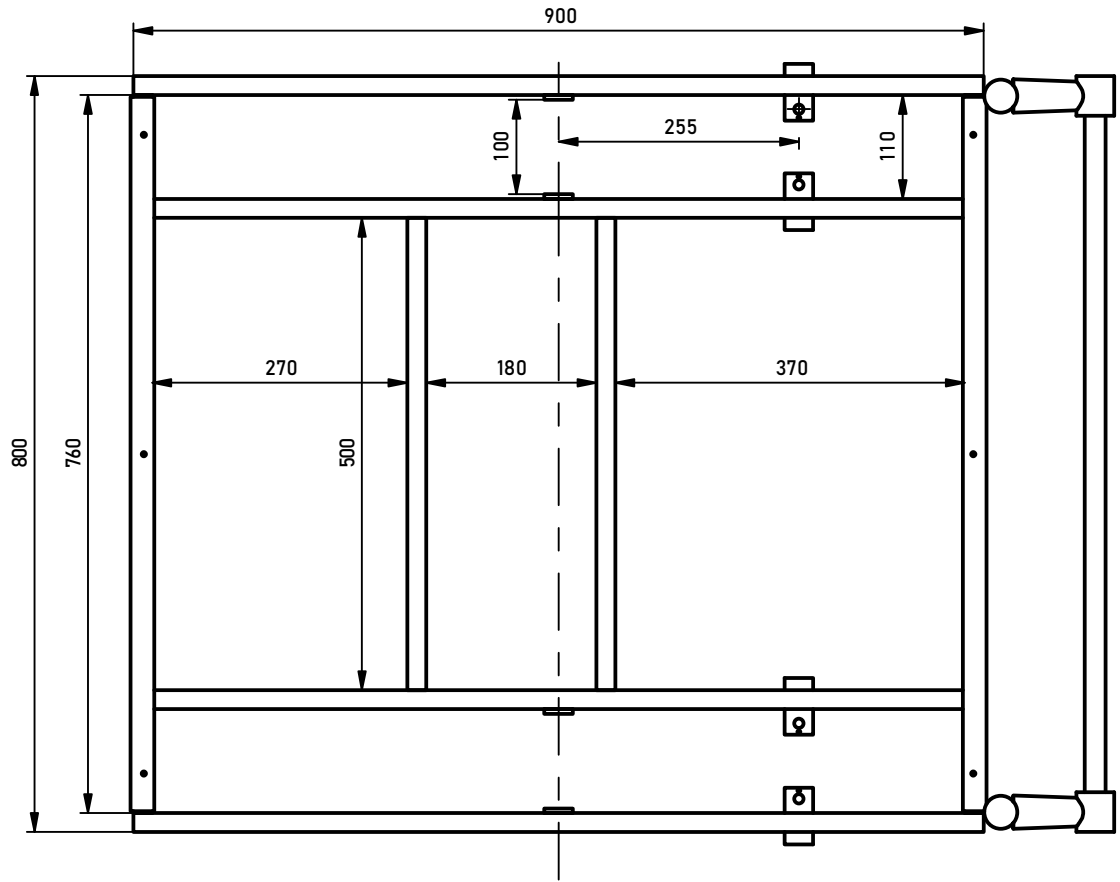

PROJECT TRICYCLE CARGO BIKE		CREATED BY A. PARDO		APPROVED BY D. Jaeger	
PART NAME Assembly2-tricycle cargo bike B		PART CODE 2		DOCUMENT TYPE ASSEMBLY	
 		LICENSE CC-BY-SA 4.0		FILE NAME Assembly2-tricycle cargo bike B	
		SCALE 1 / 15		VERSION am1.0	
		SHEET 9		QUANTITY 	
		DATE 12/1/2021			

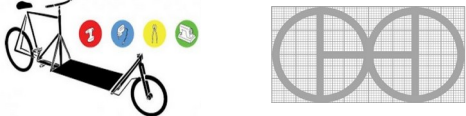

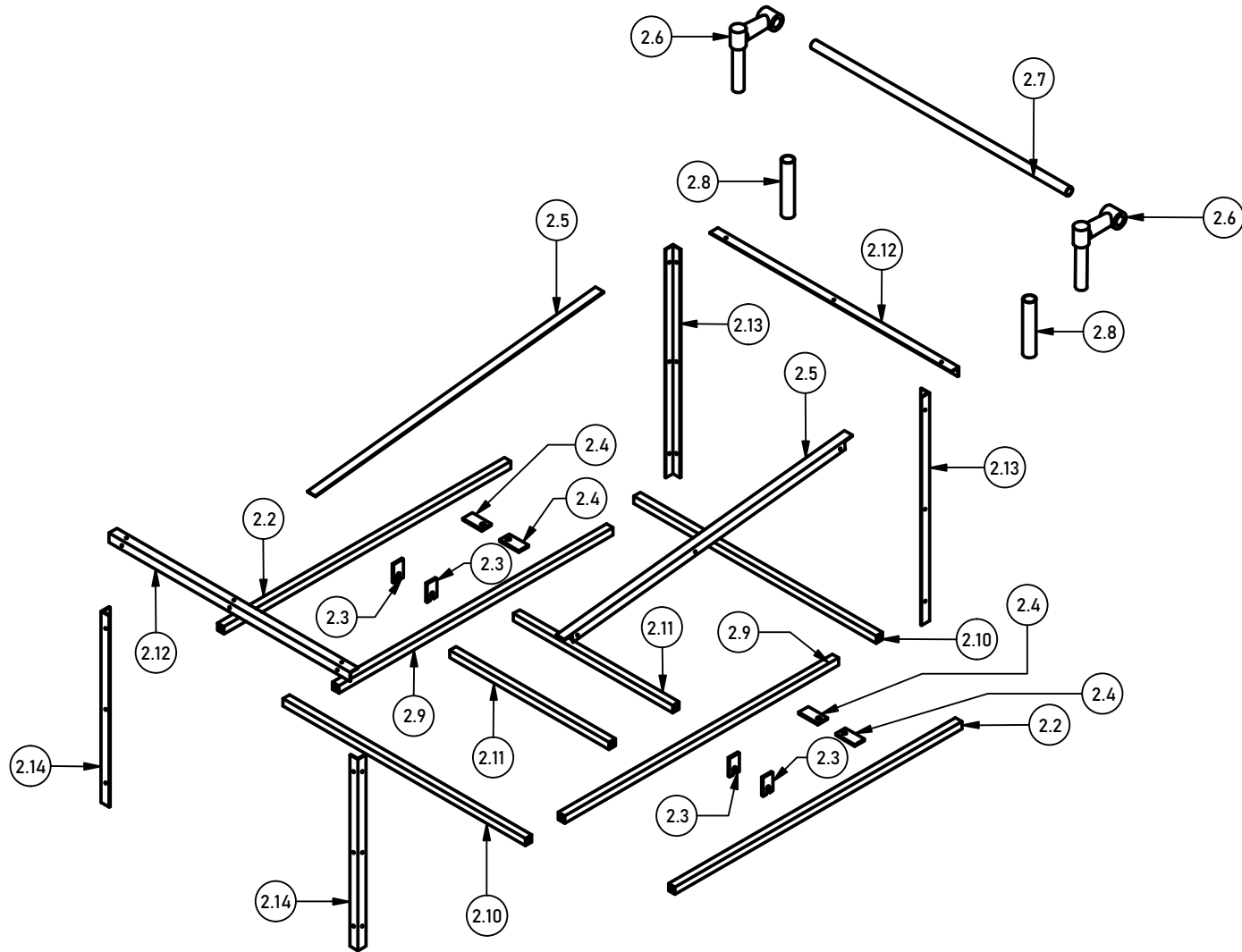
PROJECT		CREATED BY A. PARDO		APPROVED BY	
PART NAME		PART CODE		DOCUMENT TYPE	
		LICENSE CC-BY-SA 4.0		FILE NAME Assembly2-tricycle cargo bike Beam	
		SCALE 1 / 8		VERSION 10	
				QUANTITY	
				DATE	



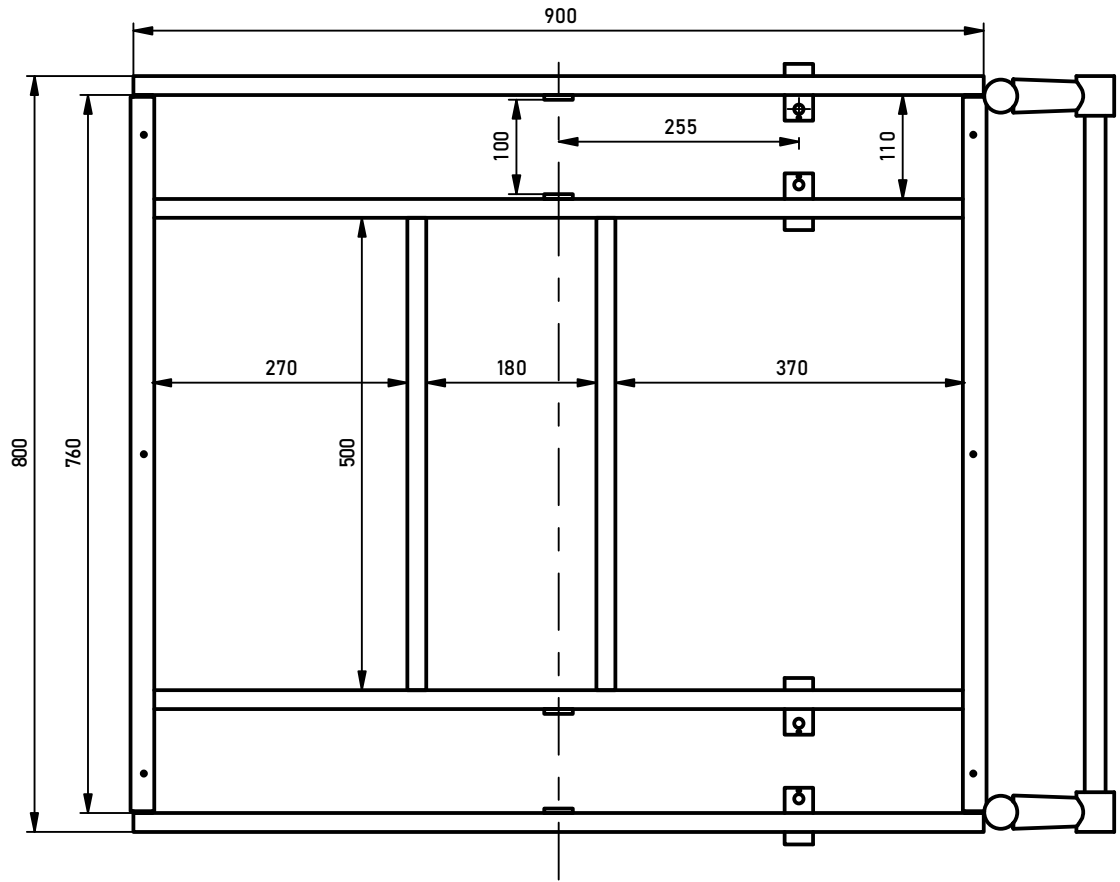

PROJECT TRICYCLE CARGO BIKE		CREATED BY A. PARDO		APPROVED BY D. Jaeger	
PART NAME Assembly2-tricycle cargo bike B		PART CODE 2		DOCUMENT TYPE ASSEMBLY	
 		LICENSE CC-BY-SA 4.0		FILE NAME Assembly2-tricycle cargo bike B	
		SCALE 1 / 15		VERSION am1.0	
		SHEET 9		QUANTITY DATE 12/1/2021	



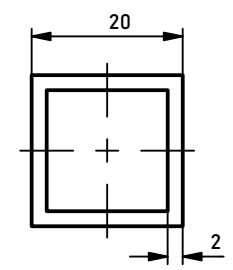
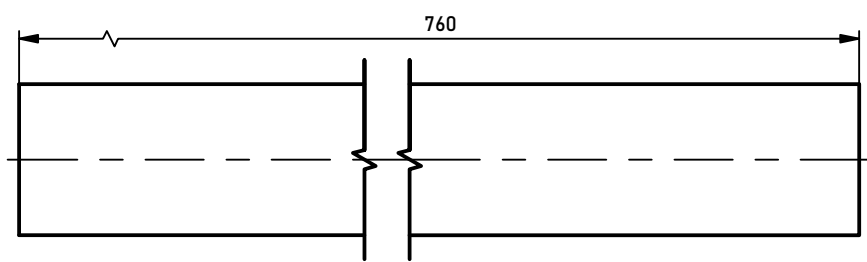
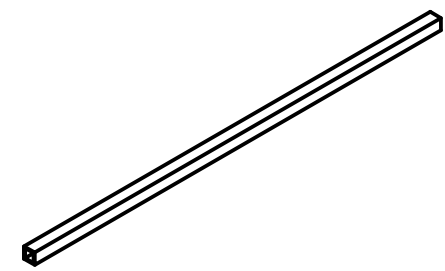

PROJECT	CREATED BY A. PARDO	APPROVED BY		
PART NAME	PART CODE	DOCUMENT TYPE	MATERIAL	
 Open Source Ecology e.V. Knobelsdorffstr. 22 14059 Berlin www.ose-germany.de +49 (0) 30 / 92282426	LICENSE CERN-OHL	FILE NAME Assembly2-tricycle cargo bike Beam	VERSION	QUANTITY
		SCALE 1 / 8	SHEET 10	DATE



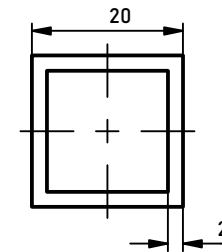
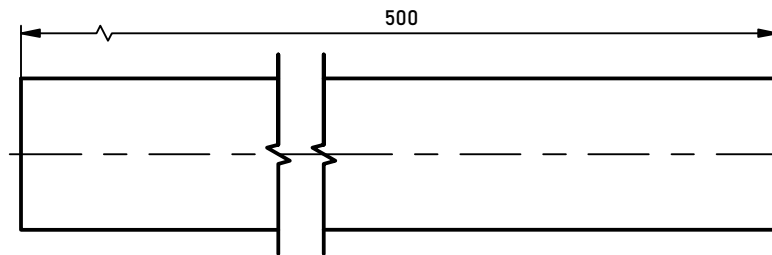
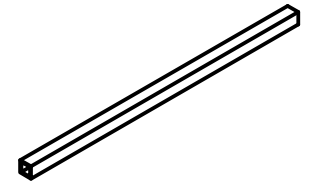

PROJECT TRICYCLE CARGO BIKE		CREATED BY A. PARDO		APPROVED BY D. Jaeger	
PART NAME wL_lacb_2.10_Parts-box-bottom		PART CODE 2.10		DOCUMENT TYPE Production	
 		LICENSE CC-BY-SA 4.0		FILE NAME wL_lacb_2.10_Parts-box-bottom .ipt	
				VERSION 1.0	
		SCALE 1:1		SHEET 18	
				DATE 12/1/2021	



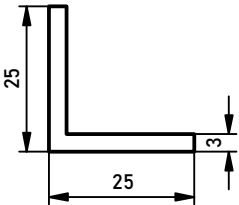
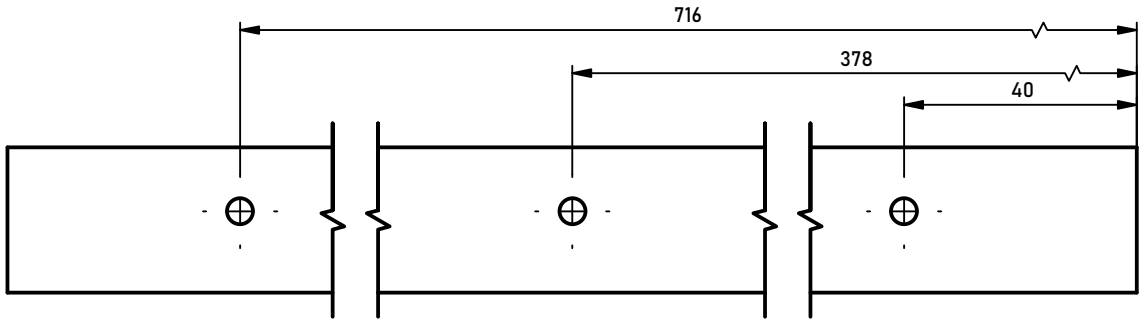
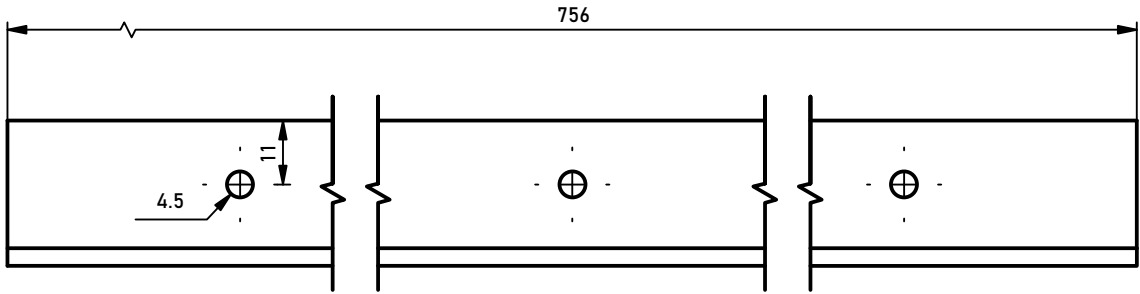
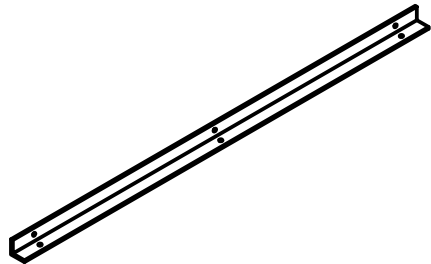

PROJECT TRICYCLE CARGO BIKE		CREATED BY A. PARDO		APPROVED BY D. Jaeger	
PART NAME wL_lacb_2.11_Parts-box-bottom		PART CODE 2.11		DOCUMENT TYPE Production	
 		LICENSE CC-BY-SA 4.0		MATERIAL A36	
		FILE NAME wL_lacb_2.11_Parts-box-bottom.ip		VERSION 1.0	QUANTITY 1
		SCALE 1:1		SHEET 19	DATE 12/1/2021



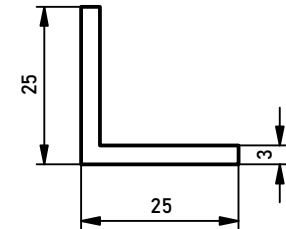
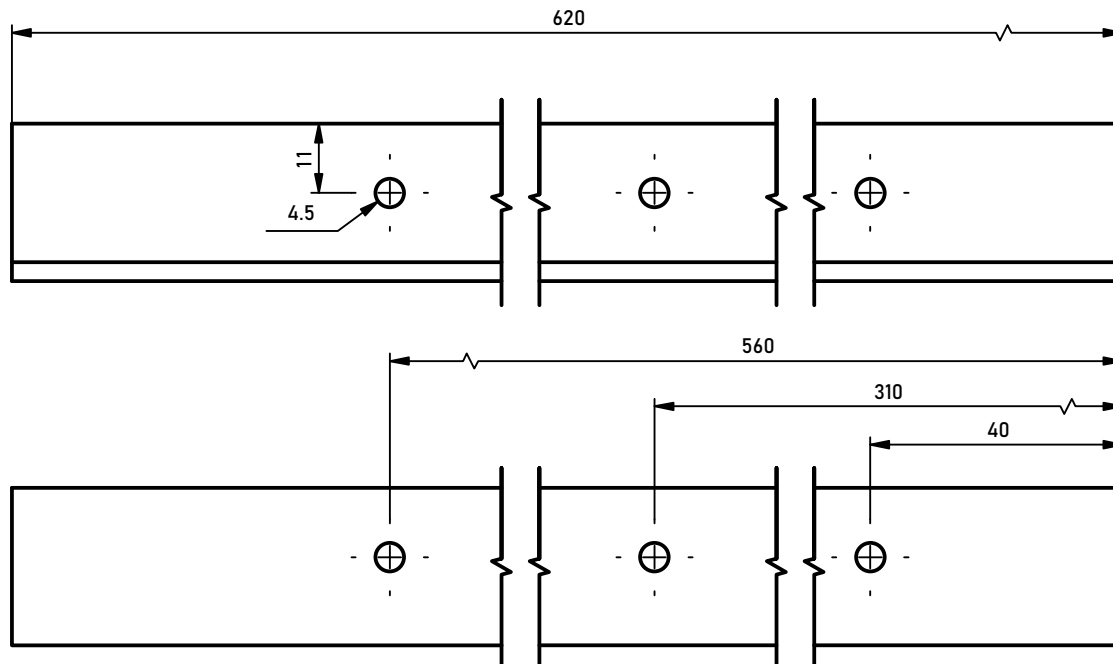
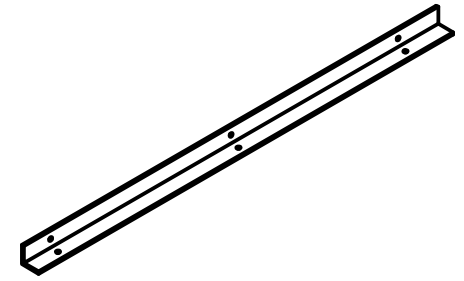

PROJECT TRICYCLE CARGO BIKE		CREATED BY A. PARDO		APPROVED BY D. Jaeger	
PART NAME wl_lacb_2.12_Angle-profile-box		PART CODE 2.12		DOCUMENT TYPE Production	
 		LICENSE CC-BY-SA 4.0		MATERIAL A36	
		FILE NAME wl_lacb_2.12_Angle-profile-box.ipr		VERSION 1.0	QUANTITY 1
		SCALE 1 : 1.3		SHEET 20	DATE 12/1/2021



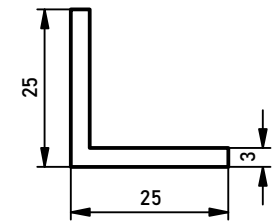
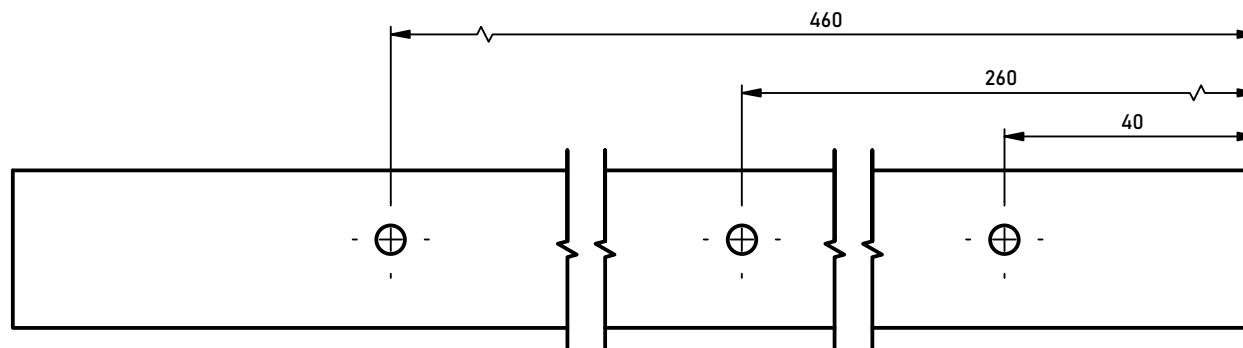
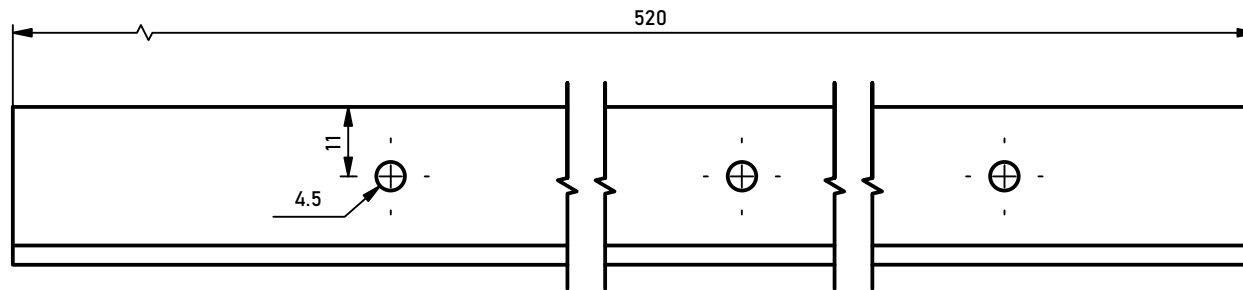
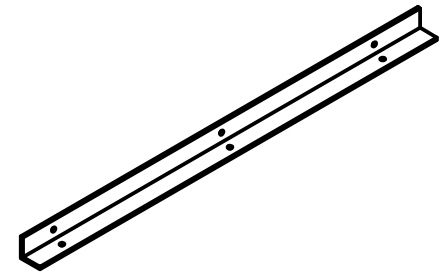

PROJECT TRICYCLE CARGO BIKE		CREATED BY A. PARDO		APPROVED BY D. Jaeger	
PART NAME wl_lacb_2.13_Angle-profile-box		PART CODE 2.13		DOCUMENT TYPE Production	
 		LICENSE CC-BY-SA 4.0		MATERIAL A36	
		FILE NAME wl_lacb_2.13_Angle-profile-box.ipf		VERSION 1.0	
		SCALE 1 : 1.2		QUANTITY 1	
		SHEET 21		DATE 12/1/2021	



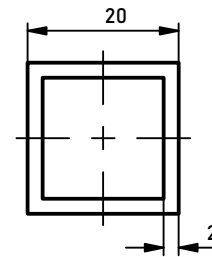
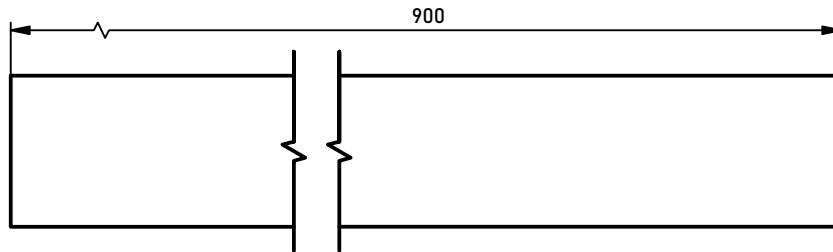
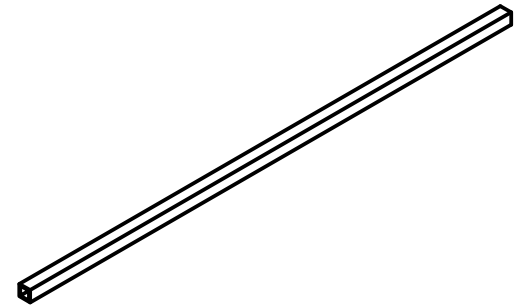

PROJECT TRICYCLE CARGO BIKE		CREATED BY A. PARDO		APPROVED BY D. Jaeger	
PART NAME wl_lacb_2.14_Angle-profile-box		PART CODE 2.14		DOCUMENT TYPE Production	
 		LICENSE CC-BY-SA 4.0		FILE NAME wl_lacb_2.14_Angle-profile-box.igt	
		SCALE 1 : 1.2		MATERIAL A36	
		VERSION 1.0		QUANTITY 1	
		SHEET 22		DATE 12/1/2021	

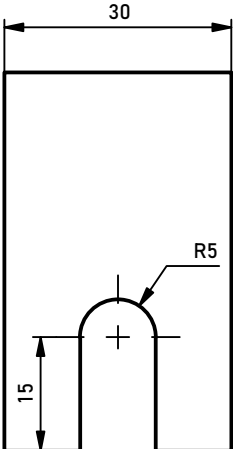
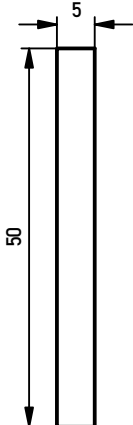
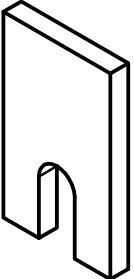

PROJECT TRICYCLE CARGO BIKE		CREATED BY A. PARDO		APPROVED BY D. Jaeger	
PART NAME wl_lacb_2.2_Parts-box-bottom		PART CODE 2.2		DOCUMENT TYPE Production	
 		LICENSE CC-BY-SA 4.0		FILE NAME wl_lacb_2.2_Parts-box-bottom.ip	
		SCALE 1:1		VERSION 1.0	
		SHEET 11		QUANTITY 1	
		DATE 12/1/2021			



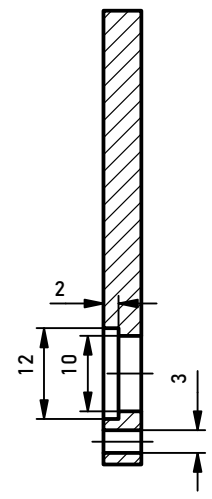
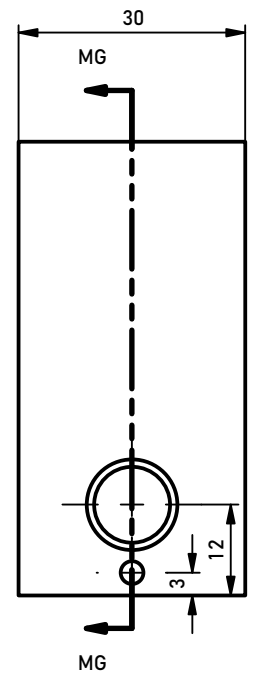
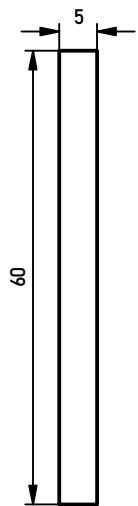
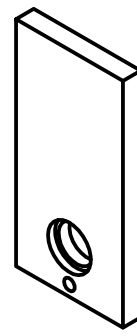

PROJECT TRICYCLE CARGO BIKE		CREATED BY A. PARDO		APPROVED BY D. Jaeger	
PART NAME wL_lacb_2.3_Wheel-mount		PART CODE 2.3		DOCUMENT TYPE Production	
 		LICENSE CC-BY-SA 4.0		MATERIAL A36	
		FILE NAME wL_lacb_2.3_Wheel-mount.ipt		VERSION 1.0	
		SCALE 1:1		SHEET 12	DATE 12/1/2021



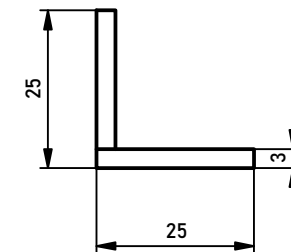
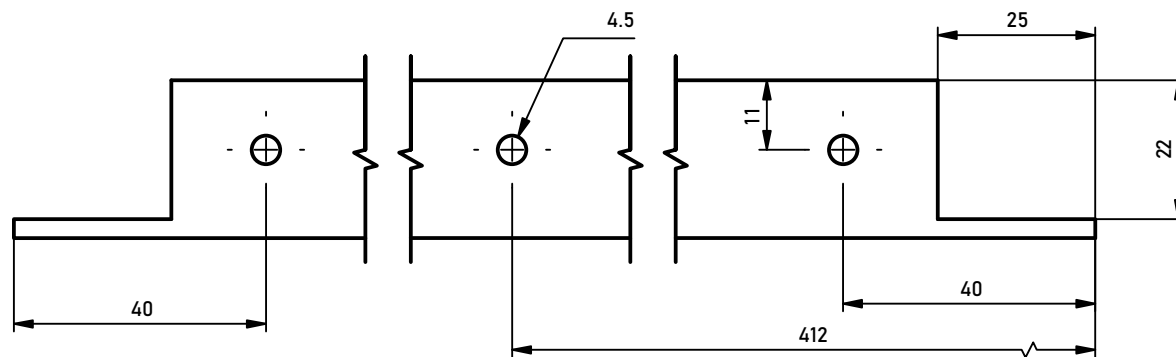
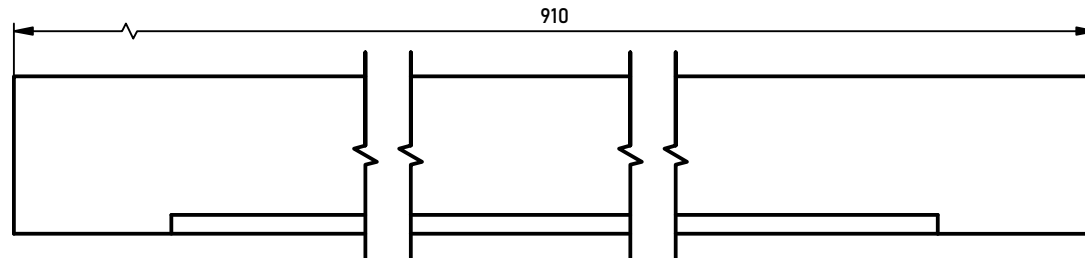
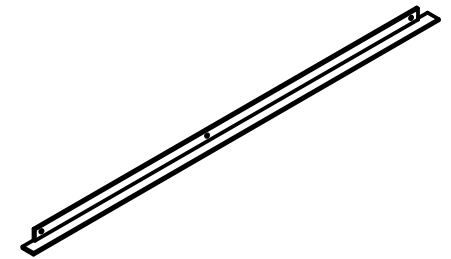

SECTION MG-MG
SCALE 1:1

PROJECT TRICYCLE CARGO BIKE		CREATED BY A. PARDO		APPROVED BY D. Jaeger	
PART NAME wL_lacb_2.4_Brake-holder		PART CODE 2.4		DOCUMENT TYPE Production	
		LICENSE CC-BY-SA 4.0		FILE NAME wL_lacb_2.4_Brake-holder.ipt	
				SCALE 1:1	
		MATERIAL A36		VERSION 1.0	
				QUANTITY 1	
				SHEET 13	
				DATE 12/1/2021	



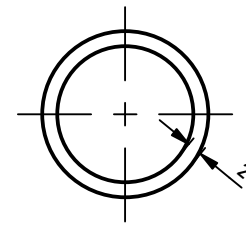
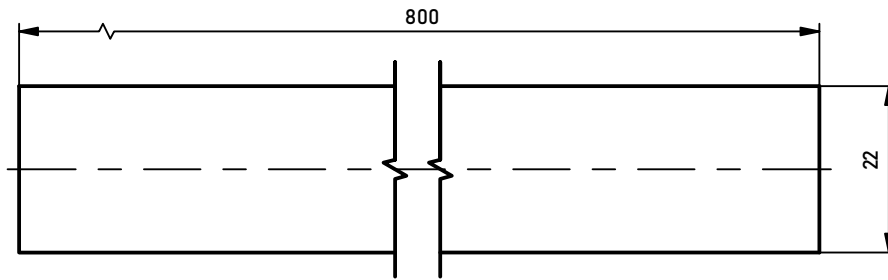
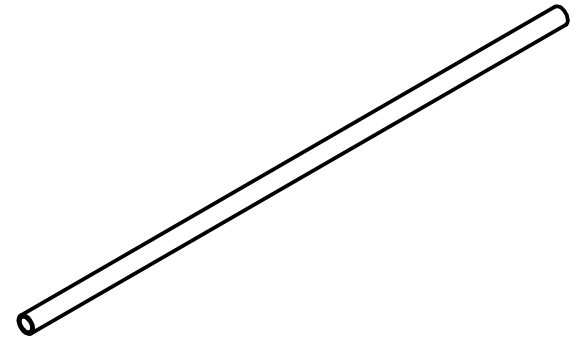

PROJECT TRICYCLE CARGO BIKE		CREATED BY A. PARDO		APPROVED BY D. Jaeger	
PART NAME wl_lacb_2.5_Angle-profile-box		PART CODE 2.5		DOCUMENT TYPE Production	
 		LICENSE CC-BY-SA 4.0		MATERIAL A36	
		FILE NAME wl_lacb_2.5_Angle-profile-box.ipf		VERSION 1.0	
		SCALE 1 : 1.2		QUANTITY 1	
		SHEET 14		DATE 12/1/2021	



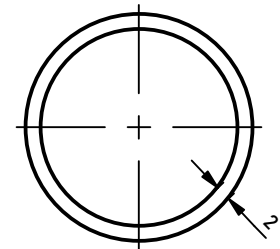
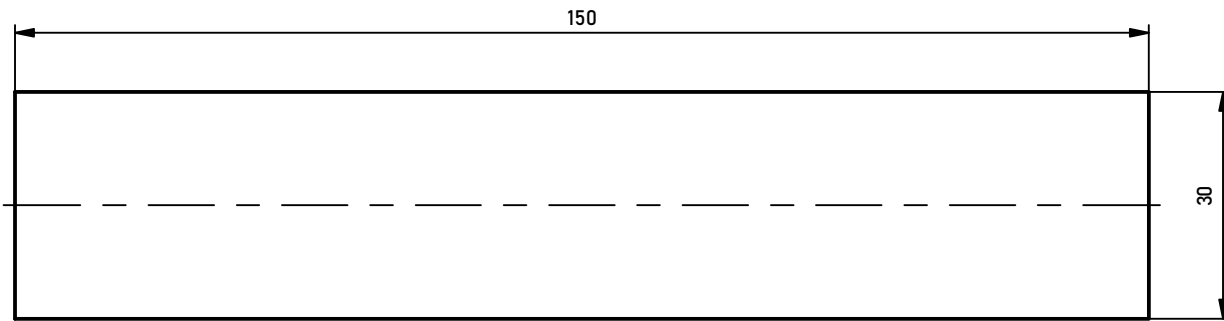
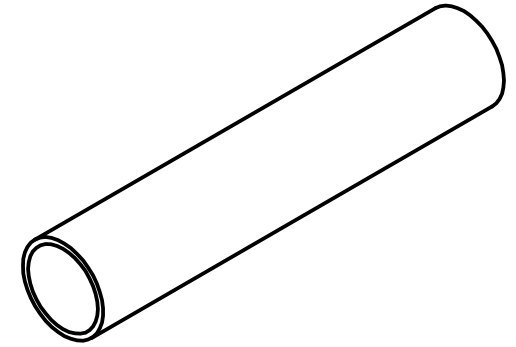

PROJECT TRICYCLE CARGO BIKE		CREATED BY A. PARDO		APPROVED BY D. Jaeger	
PART NAME wL_lacb_2.7_Steering-handle		PART CODE 2.7		DOCUMENT TYPE Production	
 		LICENSE CC-BY-SA 4.0		MATERIAL A36	
		FILE NAME wL_lacb_2.7_Steering-handle.ipt		VERSION 1.0	
		SCALE 1:1		SHEET 15	
				DATE 12/1/2021	



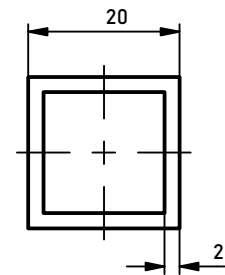
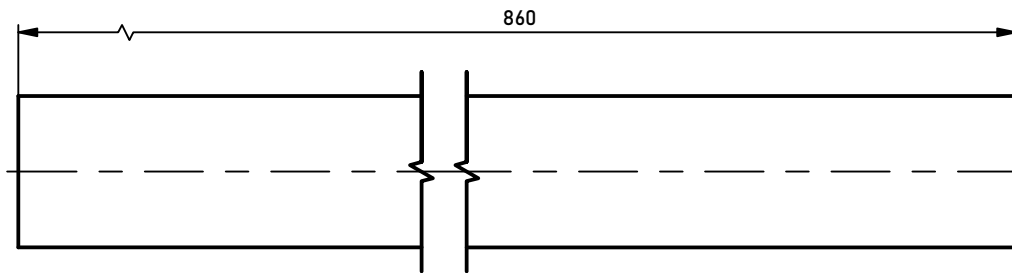
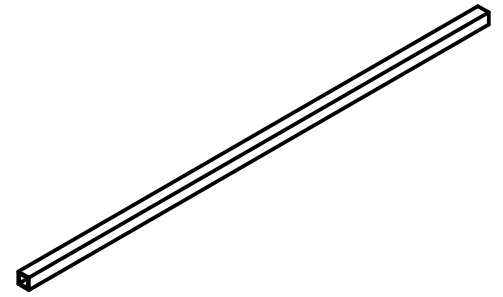

PROJECT TRICYCLE CARGO BIKE		CREATED BY A. PARDO		APPROVED BY D. Jaeger	
PART NAME wl_lacb_2.8_Wall-plate-holder		PART CODE 2.8		DOCUMENT TYPE Production	
 		LICENSE CC-BY-SA 4.0		FILE NAME wl_lacb_2.8_Wall-plate-holder.ip	
				MATERIAL A36	
		SCALE 1:1		VERSION 1.0	
				QUANTITY 1	
				SHEET 16	
				DATE 12/1/2021	



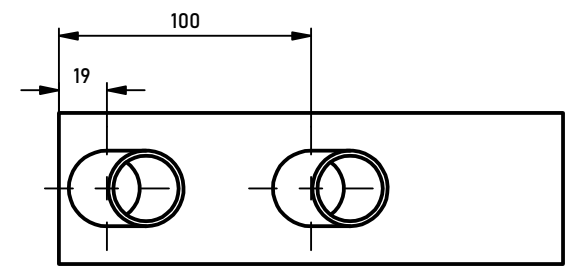
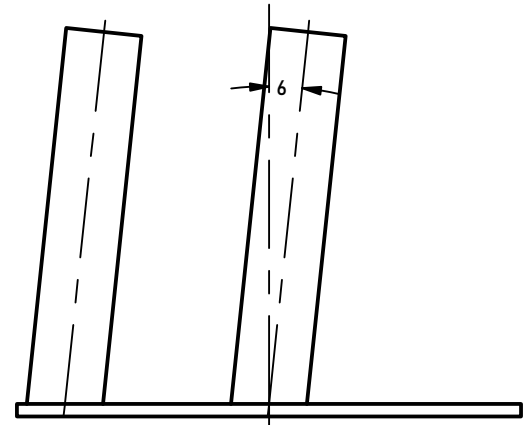
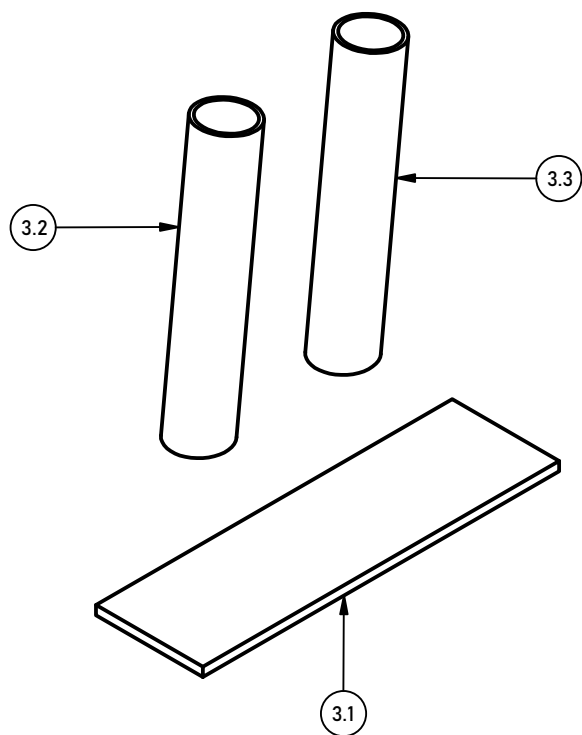

PROJECT TRICYCLE CARGO BIKE		CREATED BY A. PARDO		APPROVED BY D. Jaeger	
PART NAME wL_lacb_2.9_Parts-box-bottom		PART CODE 2.9		DOCUMENT TYPE Production	
 		LICENSE CC-BY-SA 4.0		FILE NAME wL_lacb_2.9_Parts-box-bottom.ip	
				SCALE 1:1	
		VERSION 1.0		QUANTITY 1	
		SHEET 17		DATE 12/1/2021	



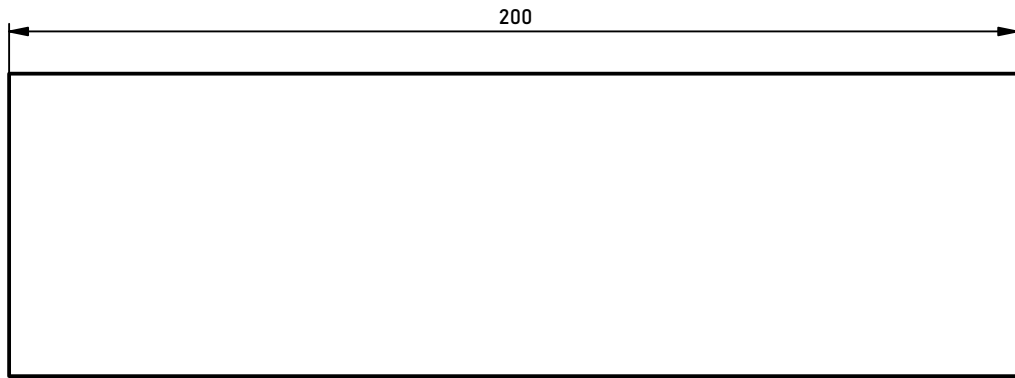
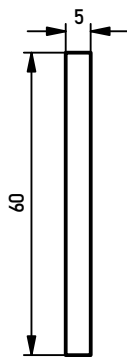
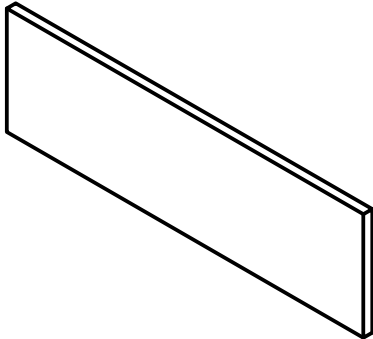

PROJECT TRICYCLE CARGO BIKE		CREATED BY A. PARDO		APPROVED BY D. Jaeger	
PART NAME Assembly3-tricycle cargo bike B		PART CODE 3.0		DOCUMENT TYPE ASSEMBLY	
 		LICENSE CC-BY-SA 4.0		FILE NAME Assembly3-tricycle cargo bike B	
				VERSION am1.0	QUANTITY
		SCALE 1 / 3	SHEET 23	DATE 15/1/2021	

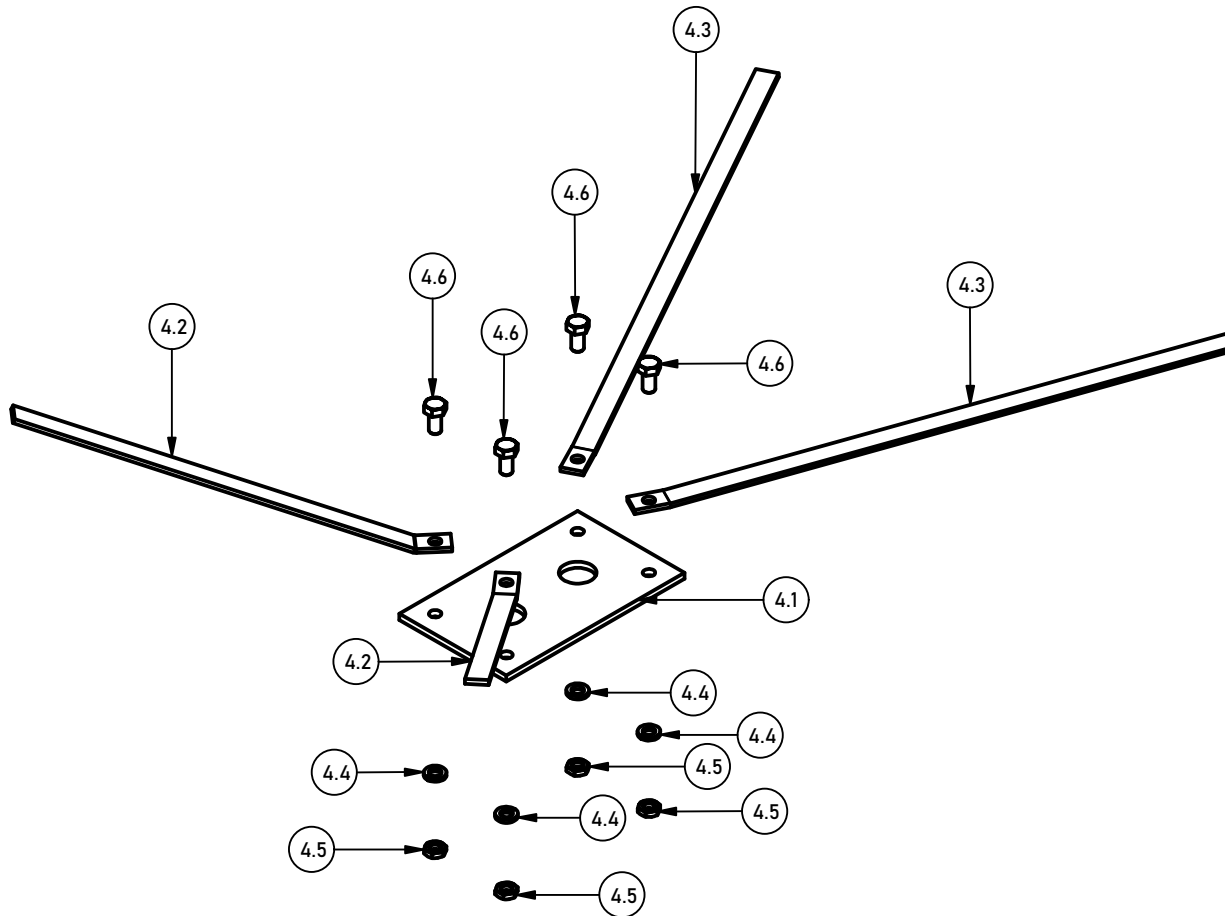

PROJECT TRICYCLE CARGO BIKE		CREATED BY A. PARDO		APPROVED BY D. Jaeger	
PART NAME wl_lacb_3.1_Head tube-plate		PART CODE 3.1		DOCUMENT TYPE Production	
 		LICENSE CC-BY-SA 4.0		FILE NAME wl_lacb_3.1_Head tube-plate.ipt	
				SCALE 1 / 1.5	
		VERSION 1.0		QUANTITY 1	
		SHEET 24		DATE 11/1/2021	



PROJECT TRICYCLE CARGO BIKE		CREATED BY A. PARDO		APPROVED BY D. Jaeger	
PART NAME Assembly4-tricycle cargo bike B		PART CODE 4.0		DOCUMENT TYPE ASSEMBLY	
 		LICENSE CC-BY-SA 4.0		FILE NAME Assembly4-tricycle cargo bike B	
		SCALE 1 / 6		VERSION am1.0	
		SHEET 25		QUANTITY 	
		DATE 15/1/2021			

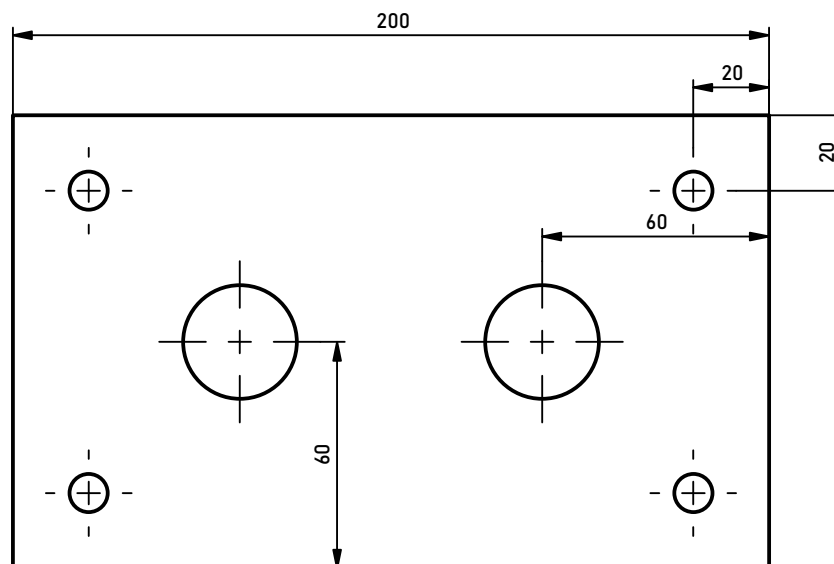
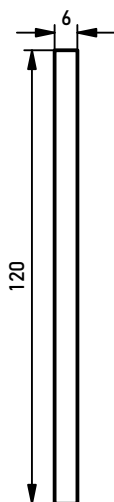
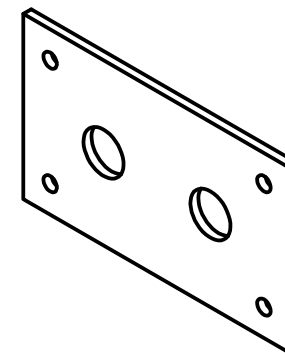

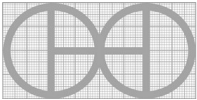
PROJECT TRICYCLE CARGO BIKE		CREATED BY A. PARDO		APPROVED BY D. Jaeger	
PART NAME wL_lacb_4.1_Security-plate		PART CODE 4.1		DOCUMENT TYPE Production	
 		LICENSE CC-BY-SA 4.0		FILE NAME wL_lacb_4.1_Security-plate.ipt	
				SCALE 1 / 2	
		MATERIAL A36		VERSION 1.0	
				QUANTITY 1	
				SHEET 26	
				DATE 11/1/2021	

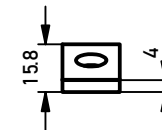
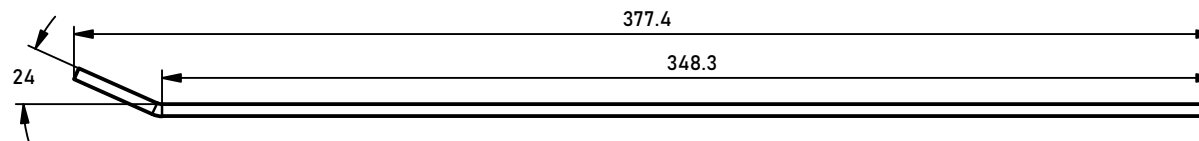
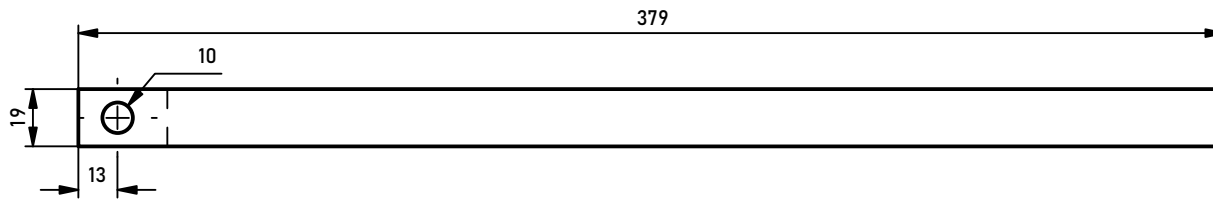
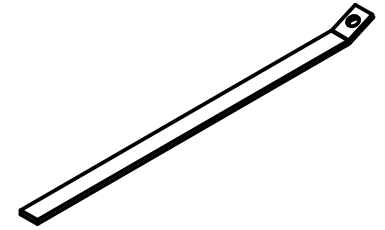

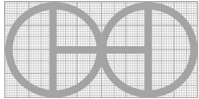
PROJECT TRICYCLE CARGO BIKE		CREATED BY A. PARDO		APPROVED BY D. Jaeger	
PART NAME wl_lacb_4.2_Stru		PART CODE 4.2		DOCUMENT TYPE Production	
 		LICENSE CC-BY-SA 4.0		FILE NAME wl_lacb_4.2_Strut.ipt	
		SCALE 1 / 2.5		MATERIAL A36	
		VERSION 1.0		QUANTITY 1	
		SHEET 27		DATE 11/1/2021	

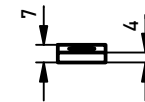
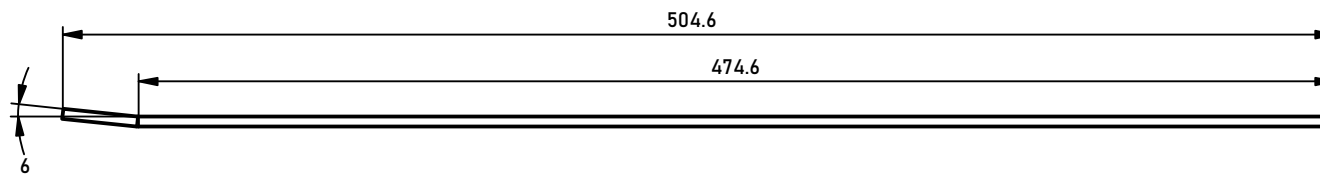
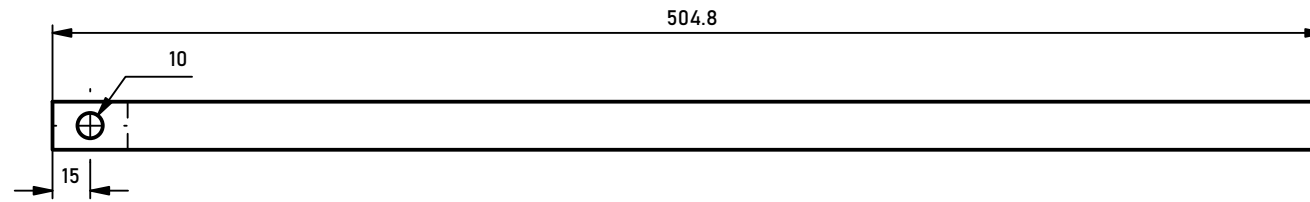
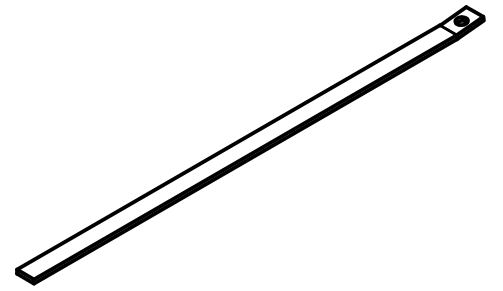

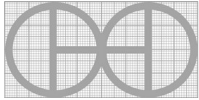
PROJECT TRICYCLE CARGO BIKE		CREATED BY A. PARDO		APPROVED BY D. Jaeger	
PART NAME wL_lacb_4.3_Strut		PART CODE 4.3		DOCUMENT TYPE Production	
 		LICENSE CC-BY-SA 4.0		MATERIAL A36	
		FILE NAME wL_lacb_4.3_Strut.ipt		VERSION 1.0	
		SCALE 1 / 3		QUANTITY 1	
				SHEET 28	
				DATE 11/1/2021	