

NOTE: ALL UNITS ARE IN MM

PROJECT		CREATED BY	APPROVED BY	DATE	VERSION
SIMPLE EFFECTIVE B. INCUBATOR		E. ARAUJO	A. MORILLO	01-06-21	1.0
PART NAME		FILE NAME			PART CODE
3D VIEWS		BABY_INCUBATOR.dwg			A1
DEVELOPED BY	REDESIGNED BY	SUPPORTED BY	DOC. TYPE	MATERIAL	QUANTITY
			ASSEMBLY		1
PRACTICAL ACTION	OHO e.V.		LICENCE	SCALE	SHEET
			CC-BY-SA 4.0		1 / 27

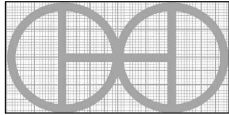
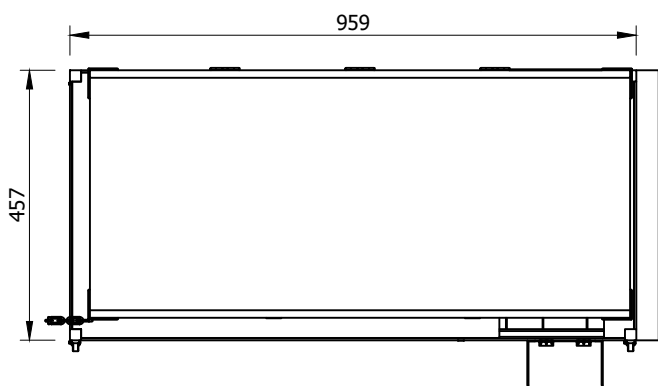
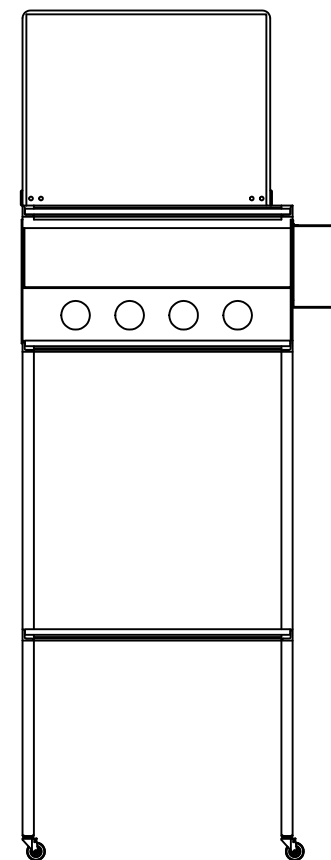
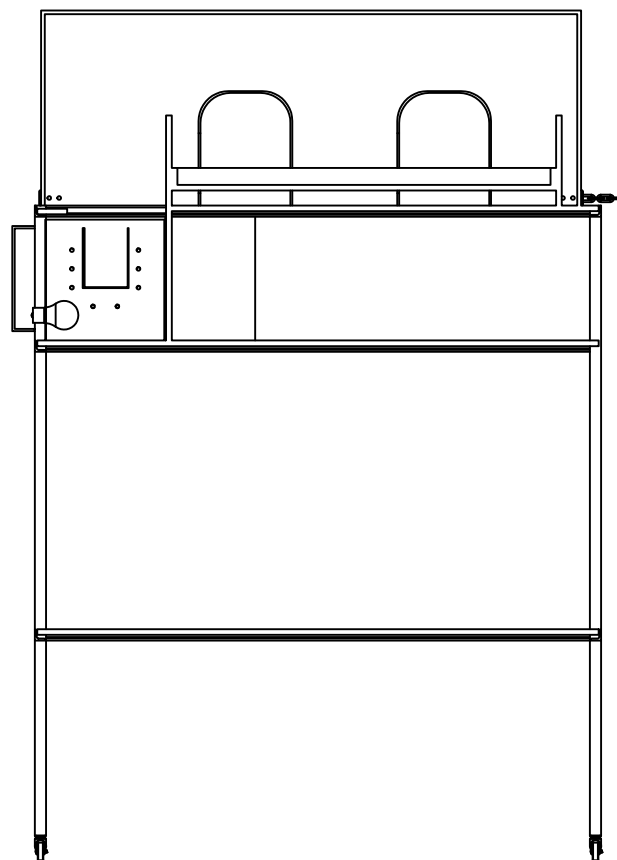
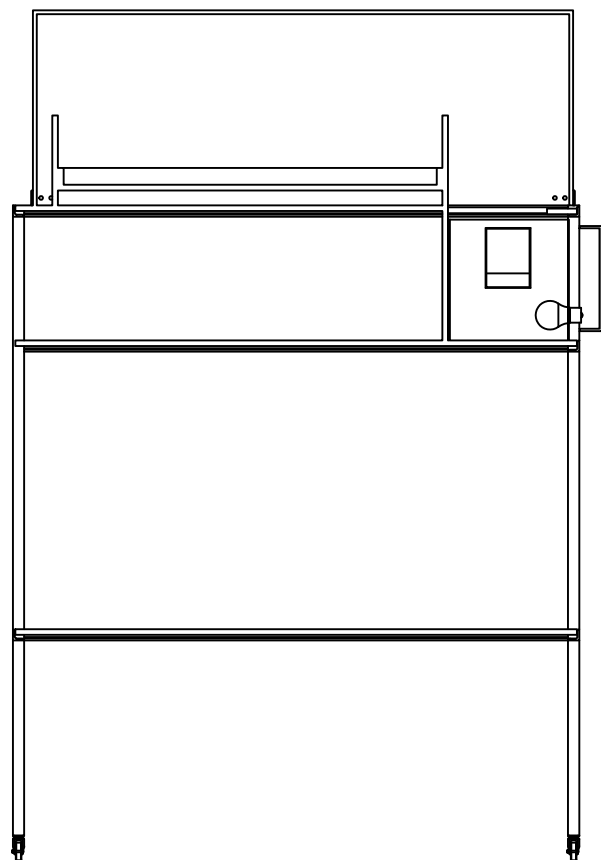
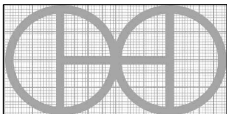

NOTE: ALL UNITS ARE IN MM

PROJECT		CREATED BY	APPROVED BY	DATE	VERSION
SIMPLE EFFECTIVE B. INCUBATOR		E. ARAUJO	A. MORILLO	01-06-21	1.0
PART NAME		FILE NAME			PART CODE
3D VIEWS		BABY_INCUBATOR.dwg			A1
DEVELOPED BY	REDESIGNED BY	SUPPORTED BY	DOC. TYPE	MATERIAL	QUANTITY
			ASSEMBLY		1
PRACTICAL ACTION	OHO e.V.		LICENCE	SCALE	SHEET
			CC-BY-SA 4.0		2 / 27

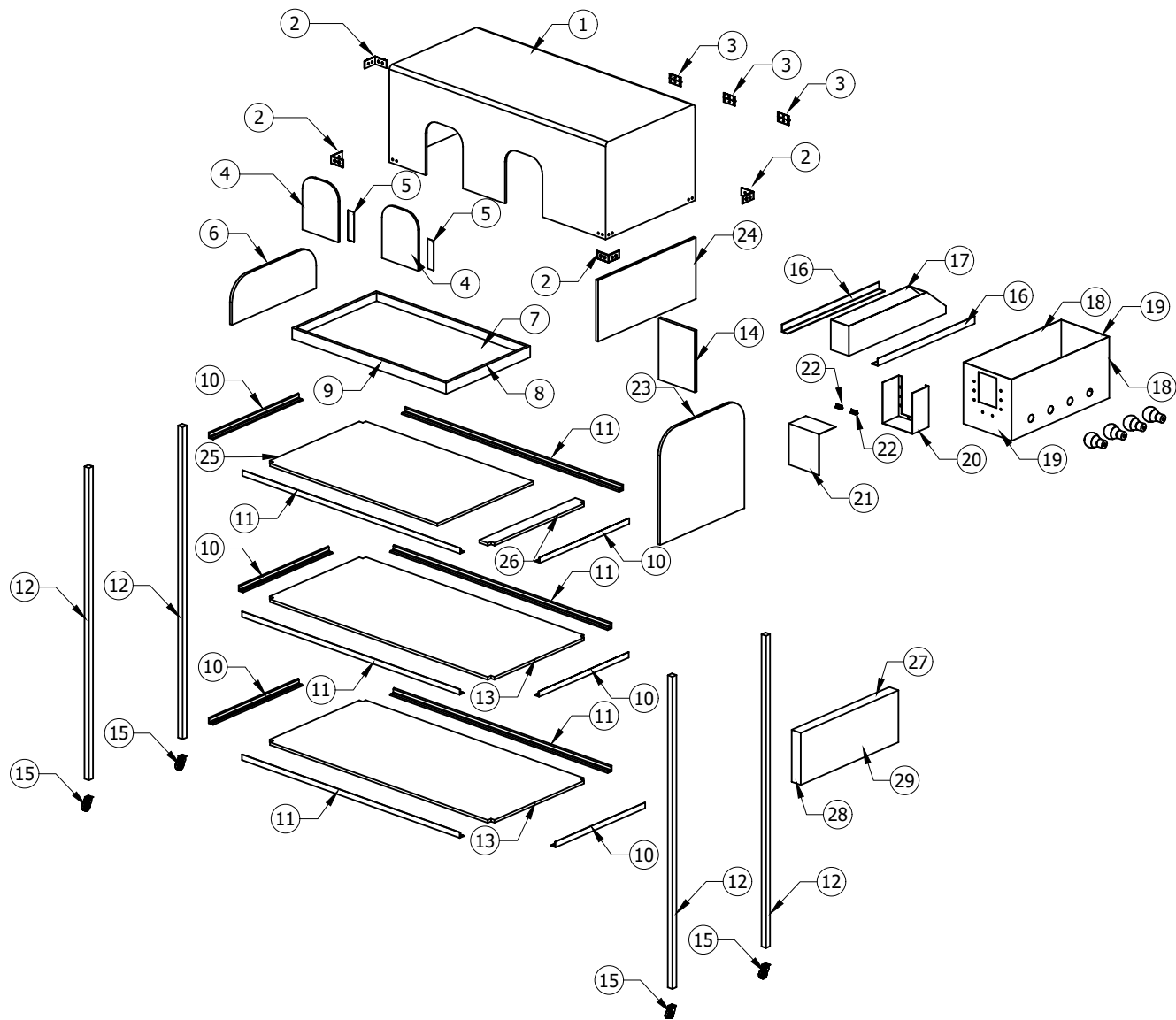

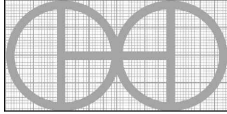
PROJECT		CREATED BY	APPROVED BY	DATE	VERSION
SIMPLE EFFECTIVE B. INCUBATOR		E. ARAUJO	A. MORILLO	01-06-21	1.0
PART NAME		FILE NAME			PART CODE
EXPLODED 3D VIEW		BABY_INCUBATOR.dwg			A2
DEVELOPED BY	REDESIGNED BY	SUPPORTED BY	DOC. TYPE	MATERIAL	QUANTITY
			ASSEMBLY		1
PRACTICAL ACTION	OHO e.V.		LICENCE	SCALE	SHEET
			CC-BY-SA 4.0		3 / 27

PART LIST

POS	POS.OLD	QTY	PART NAME	PART CODE	PART TYPE	SPECIFICATIONS	SHEET
A1			3D VIEWS	A1			1 - 2
A2			EXPLODED 3D VIEWS	A2			3
B1			PART LIST	B1			4
1		1	CANOPY	1	BUY	TRANSPARENT ACRYLIC	
2		4	REINFORCING BRACKET	2	PRODUCTION	STEEL C45	5
3		3	CANOPY HINGES	3	BUY	2"	
4		2	DOORS 6"X1½"	4	BUY	TRANSPARENT ACRYLIC	
5		2	SCOTCH TAPE DOOR	5	BUY	TAPE	
6		1	PARTITION	6	PRODUCTION	PLYWOOD ¾", LAMINATE	6
7		1	BABY TRAY SHEET	7	PRODUCTION	PLYWOOD ¾", LAMINATE	7
8		2	BABY TRAY EDGE1	8	PRODUCTION	PLYWOOD ¾", LAMINATE	8
9		2	BABY TRAY EDGE2	9	PRODUCTION	PLYWOOD ¾", LAMINATE	9
10		6	SUPPORTS 1	10	PRODUCTION	STEEL ASTM 1045 3/4" ANGLE IRON	10
11		6	SUPPORTS 2	11	PRODUCTION	STEEL ASTM 1045 3/4" ANGLE IRON	11
12		4	LEGS	12	PRODUCTION	STEEL ASTM A36 3/4" SQUARE SECTION STEEL	12
13		2	TOP AND SHELVES	13	PRODUCTION	PLYWOOD ¾", LAMINATE	13
14		1	ELECTRICAL BOX FRONT	14	PRODUCTION	PLYWOOD ¾", LAMINATE	14
15		4	WHEELS	15	BUY	1-1/2"	
16		2	HUMIDIFIER BRACKET	16	PRODUCTION	ALUMINIUM, ANGLE 1"	15
17		1	HUMIDIFIER TRAY	17	PRODUCTION	ALUMINIUM SHEET 2-3 MM	16
18		2	HUMIDIFIER COVER SHEET1	18	PRODUCTION	ALUMINIUM SHEET 2-3 MM	17
19		2	HUMIDIFIER COVER SHEET2	19	PRODUCTION	ALUMINIUM SHEET 2-3 MM	18
20		1	FIXED LOWER PART	20	PRODUCTION	ALUMINIUM SHEET 2-3 MM	19
21		1	HUMIDIFIER COVER FRONT	21	PRODUCTION	ALUMINIUM SHEET 2-3 MM	20
22		2	HUMIDIFIER COVER HINGES	22	BUY	1"	
23		1	PARTITION 2	23	PRODUCTION	PLYWOOD ¾", LAMINATE	21
24		1	ELECTRICAL BOX LATERAL	24	PRODUCTION	PLYWOOD ¾", LAMINATE	22
25		1	TOP AND SHELVES 2	25	PRODUCTION	PLYWOOD ¾", LAMINATE	23
26		1	TOP AND SHELVES 3	26	PRODUCTION	PLYWOOD ¾", LAMINATE	24
27		2	ELECTRICAL BOX EDGE 1	27	PRODUCTION	PLYWOOD ¾", LAMINATE	25
28		2	ELECTRICAL BOX EDGE 2	28	PRODUCTION	PLYWOOD ¾", LAMINATE	26
29		1	ELECTRICAL BOX SHEET	29	PRODUCTION	PLYWOOD ¾", LAMINATE	27

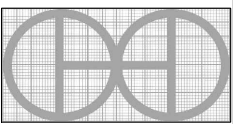
PROJECT		CREATED BY	APPROVED BY	DATE	VERSION
SIMPLE EFFECTIVE B. INCUBATOR		E. ARAUJO	A. MORILLO	01-06-21	1.0
PART NAME		FILE NAME			PART CODE
PART LIST		HE_ME_PARTLIST_BABY_INCUBATOR.xlsx			B1
DEVELOPED BY	REDESIGNED BY	SUPPORTED BY	DOC. TYPE	MATERIAL	QUANTITY
			PART LIST		1
			LICENCE	SCALE	SHEET
PRACTICAL ACTION	OHO e.V.		CC-BY-SA 4.0		4 / 27

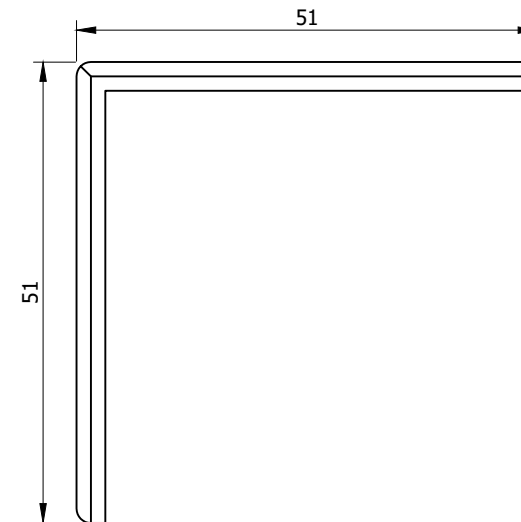
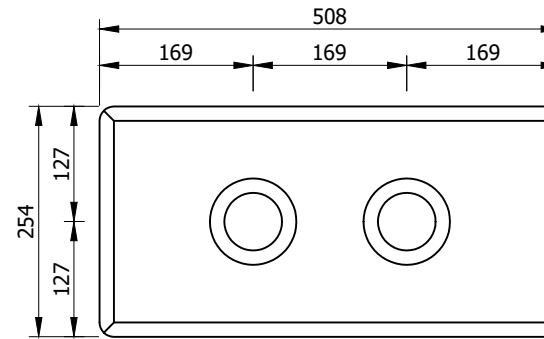
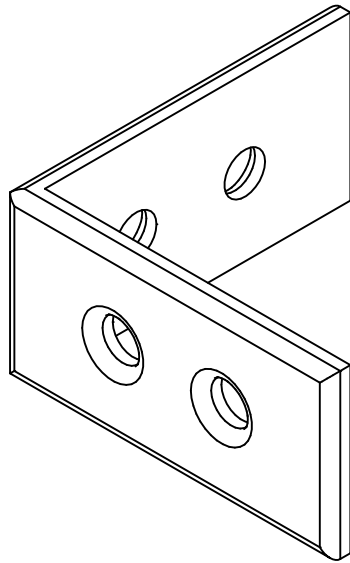

NOTE: ALL UNITS ARE IN MM

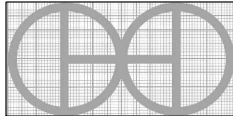
PROJECT		CREATED BY	APPROVED BY	DATE	VERSION
SIMPLE EFFECTIVE B. INCUBATOR		E. ARAUJO	A. MORILLO	01-06-21	1.0
PART NAME		FILE NAME			PART CODE
REINFORCING BRACKET		BABY_INCUBATOR.dwg			2
DEVELOPED BY	REDESIGNED BY	SUPPORTED BY	DOC. TYPE	MATERIAL	QUANTITY
			PART	STEEL C45	1
			LICENCE	SCALE	SHEET
PRACTICAL ACTION	OHO e.V.		CC-BY-SA 4.0		5 / 27

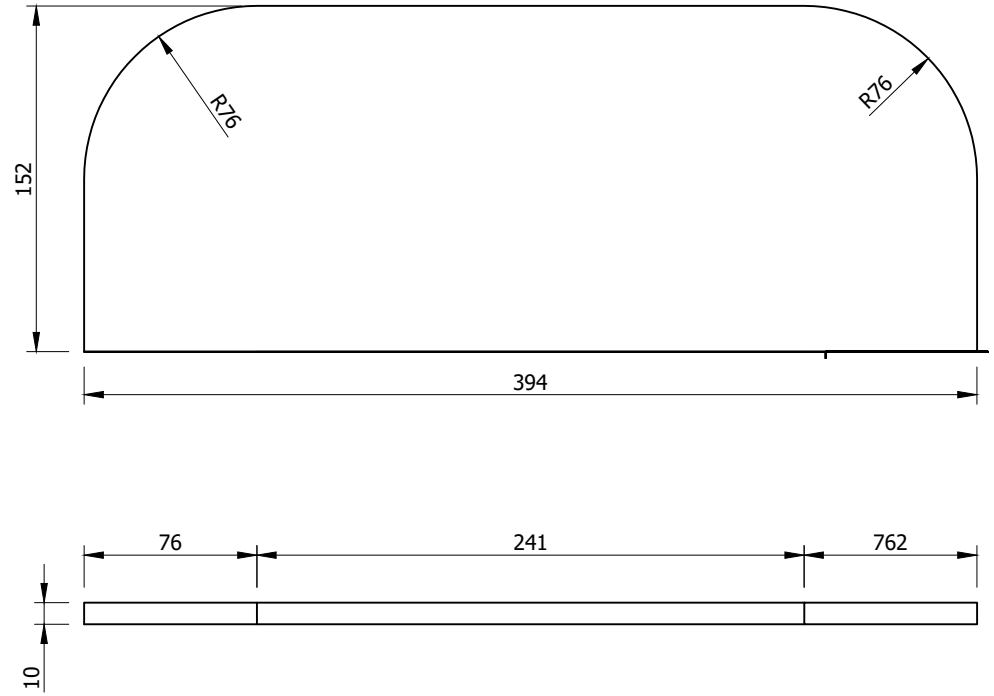
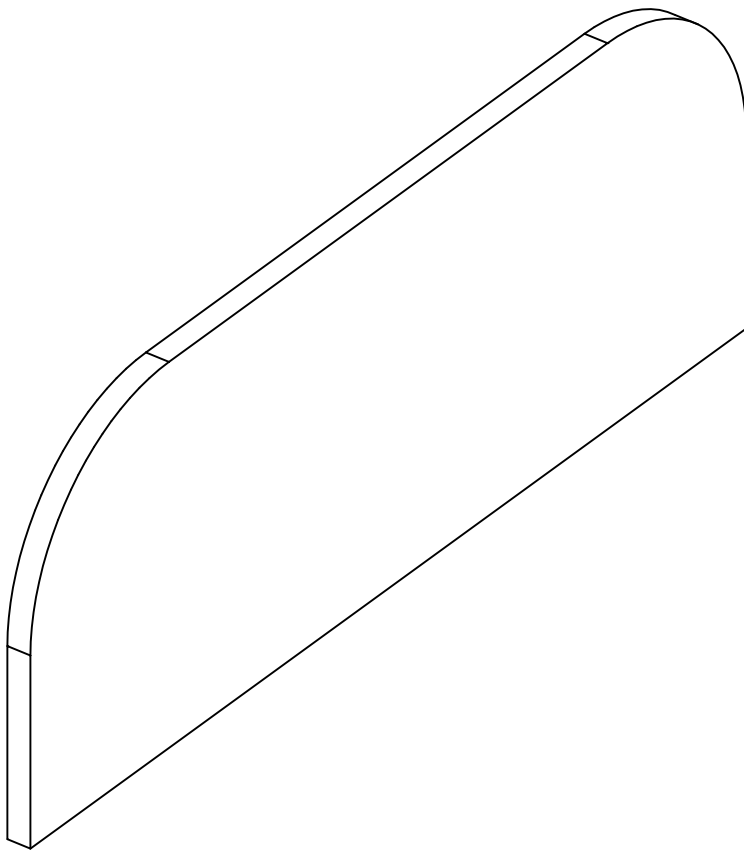

NOTE: ALL UNITS ARE IN MM

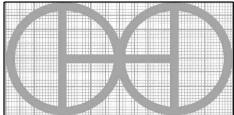
PROJECT		CREATED BY	APPROVED BY	DATE	VERSION
SIMPLE EFFECTIVE B. INCUBATOR		E. ARAUJO	A. MORILLO	01-06-21	1.0
PART NAME		FILE NAME			PART CODE
PARTITION		BABY_INCUBATOR.dwg			6
DEVELOPED BY	REDESIGNED BY	SUPPORTED BY	DOC. TYPE	MATERIAL	QUANTITY
			PART	PLYWOOD 3/8"	1
			LICENCE	SCALE	SHEET
PRACTICAL ACTION	OHO e.V.		CC-BY-SA 4.0		6 / 27

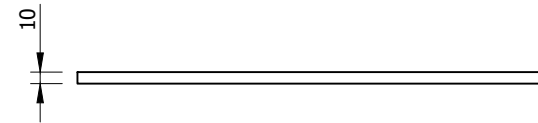
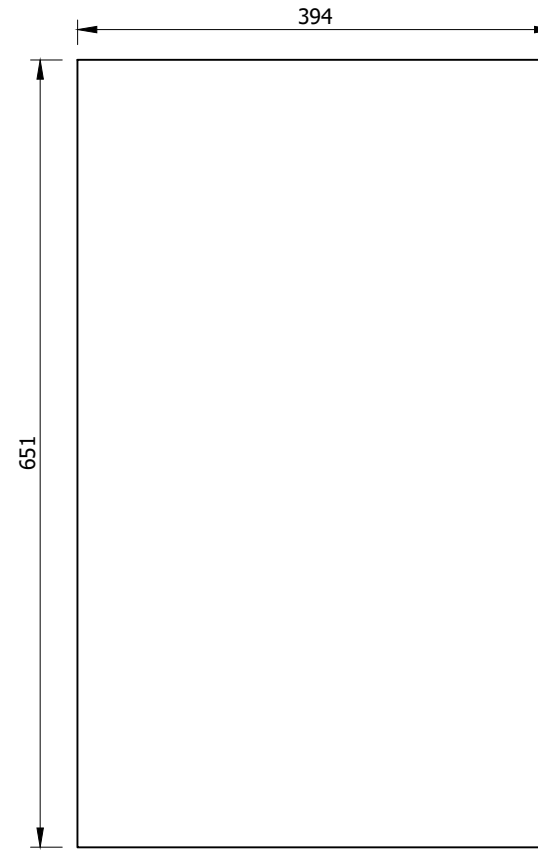
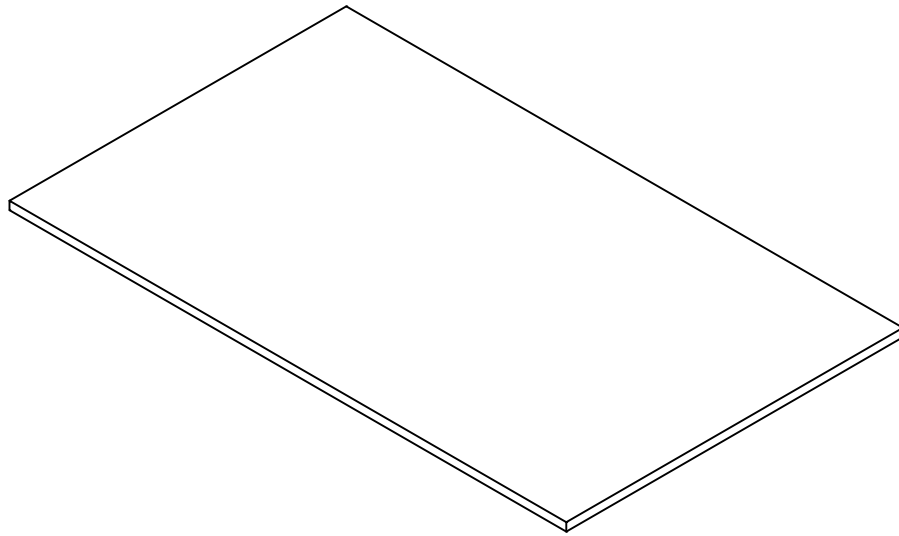

NOTE: ALL UNITS ARE IN MM

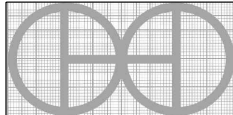
PROJECT		CREATED BY	APPROVED BY	DATE	VERSION
SIMPLE EFFECTIVE B. INCUBATOR		E. ARAUJO	A. MORILLO	01-06-21	1.0
PART NAME		FILE NAME			PART CODE
BABY TRAY SHEET		BABY_INCUBATOR.dwg			7
DEVELOPED BY	REDESIGNED BY	SUPPORTED BY	DOC. TYPE	MATERIAL	QUANTITY
			PART	PLYWOOD 3/8"	1
			LICENCE	SCALE	SHEET
PRACTICAL ACTION	OHO e.V.		CC-BY-SA 4.0		7 / 27

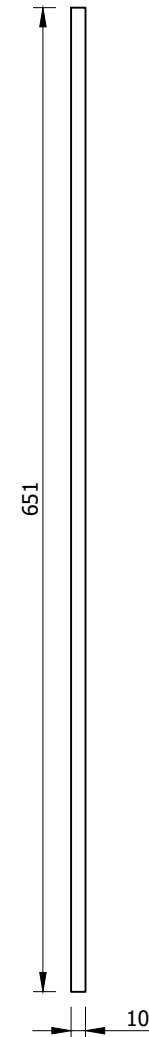
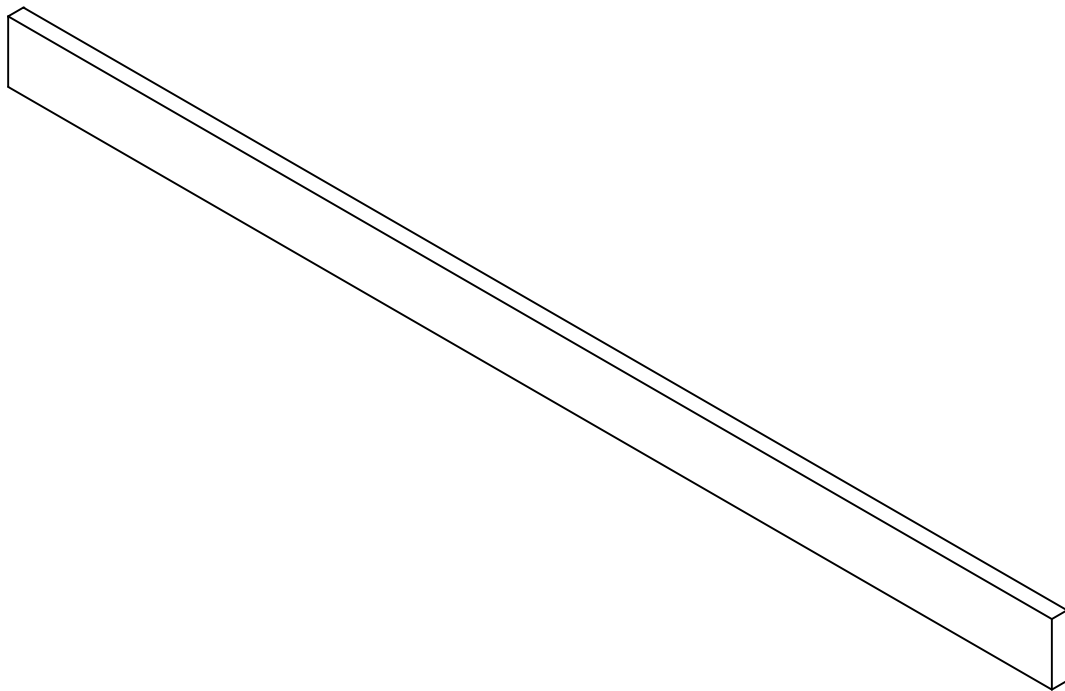

NOTE: ALL UNITS ARE IN MM

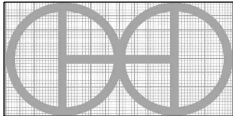
PROJECT		CREATED BY	APPROVED BY	DATE	VERSION
SIMPLE EFFECTIVE B. INCUBATOR		E. ARAUJO	A. MORILLO	01-06-21	1.0
PART NAME		FILE NAME			PART CODE
BABY TRAY EDGE1		BABY_INCUBATOR.dwg			8
DEVELOPED BY	REDESIGNED BY	SUPPORTED BY	DOC. TYPE	MATERIAL	QUANTITY
			PART	PLYWOOD 3/8"	2
PRACTICAL ACTION	OHO e.V.		LICENCE	SCALE	SHEET
			CC-BY-SA 4.0		8 / 27

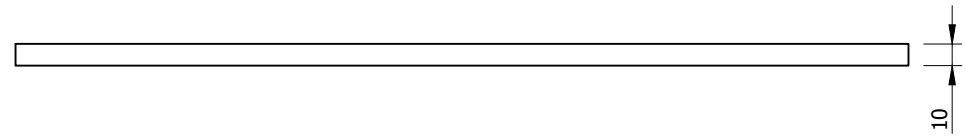
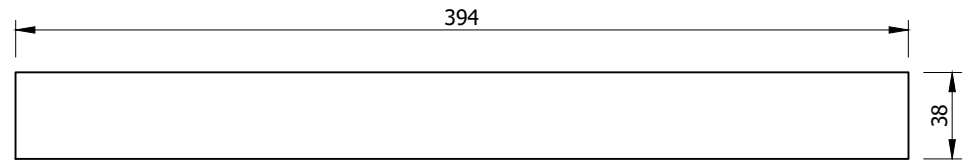
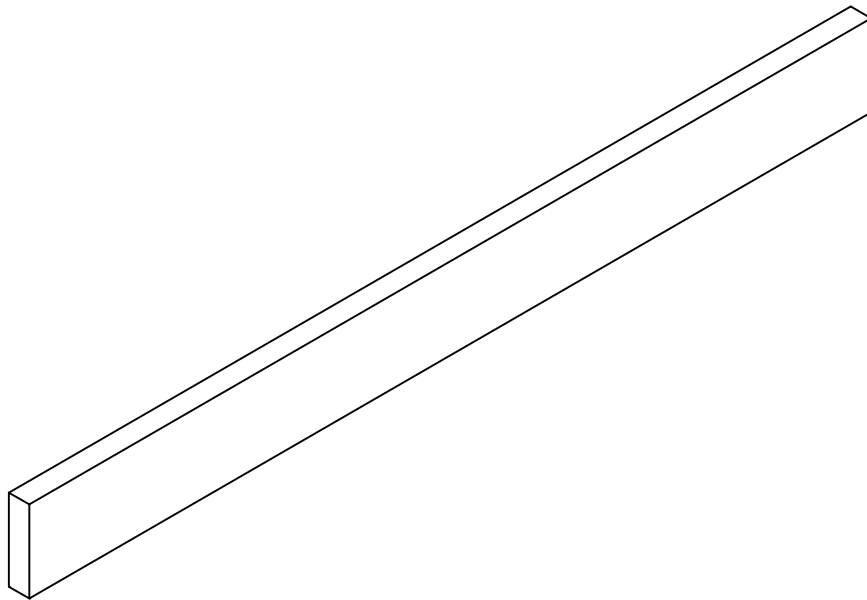

NOTE: ALL UNITS ARE IN MM

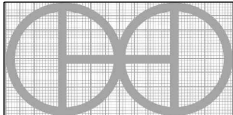
PROJECT		CREATED BY	APPROVED BY	DATE	VERSION
SIMPLE EFFECTIVE B. INCUBATOR		E. ARAUJO	A. MORILLO	01-06-21	1.0
PART NAME		FILE NAME			PART CODE
BABY TRAY EDGE2		BABY_INCUBATOR.dwg			9
DEVELOPED BY	REDESIGNED BY	SUPPORTED BY	DOC. TYPE	MATERIAL	QUANTITY
			PART	PLYWOOD 3/8"	2
			LICENCE	SCALE	SHEET
PRACTICAL ACTION	OHO e.V.		CC-BY-SA 4.0		9 / 27

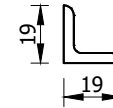
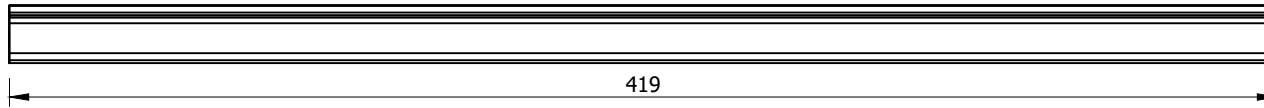
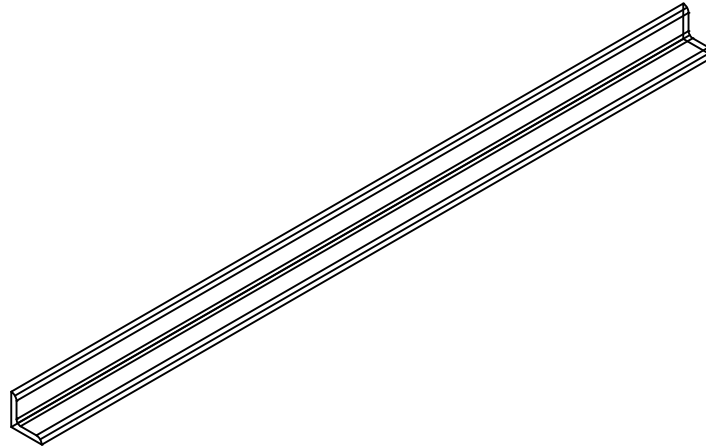

NOTE: ALL UNITS ARE IN MM

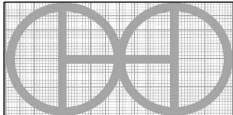
PROJECT		CREATED BY	APPROVED BY	DATE	VERSION
SIMPLE EFFECTIVE B. INCUBATOR		E. ARAUJO	A. MORILLO	01-06-21	1.0
PART NAME		FILE NAME			PART CODE
SUPPORTS 1		BABY_INCUBATOR.dwg			10
DEVELOPED BY	REDESIGNED BY	SUPPORTED BY	DOC. TYPE	MATERIAL	QUANTITY
			PART	STEEL ASTM 1045	6
PRACTICAL ACTION	OHO e.V.		LICENCE	SCALE	SHEET
			CC-BY-SA 4.0		10 / 27

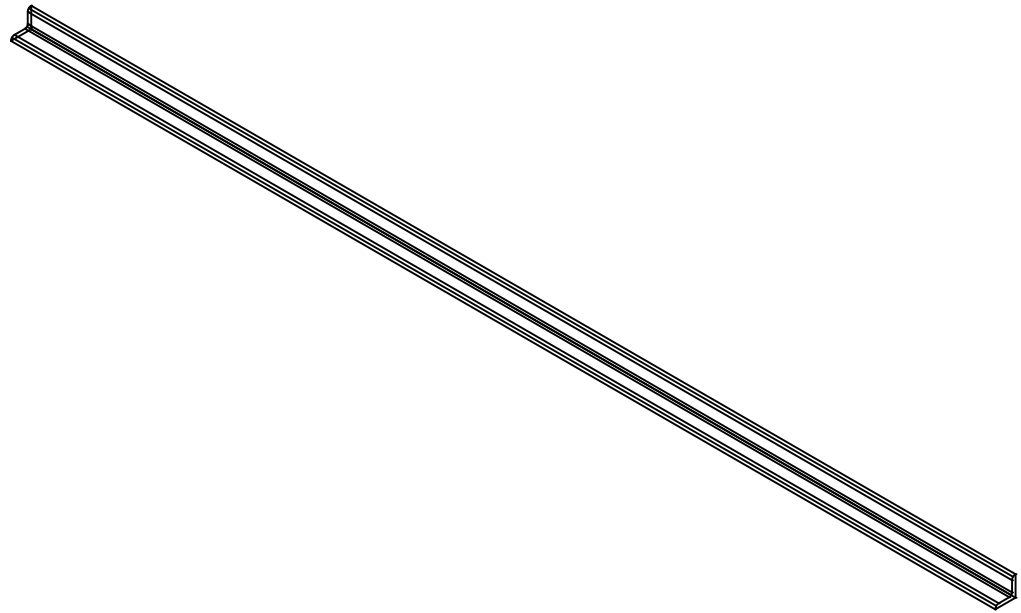
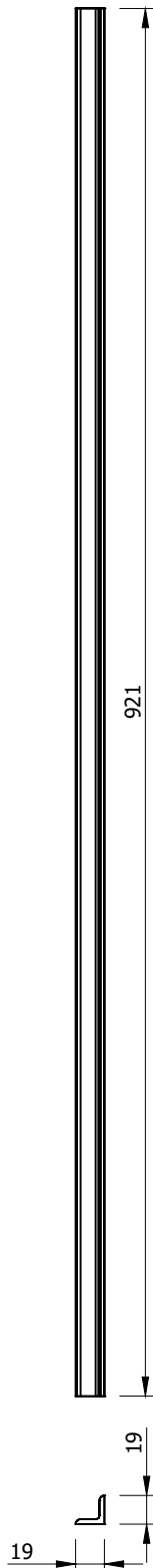

NOTE: ALL UNITS ARE IN MM

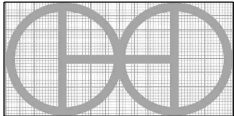
PROJECT		CREATED BY	APPROVED BY	DATE	VERSION
SIMPLE EFFECTIVE B. INCUBATOR		E. ARAUJO	A. MORILLO	01-06-21	1.0
PART NAME		FILE NAME			PART CODE
SUPPORTS 2		BABY_INCUBATOR.dwg			11
DEVELOPED BY	REDESIGNED BY	SUPPORTED BY	DOC. TYPE	MATERIAL	QUANTITY
			PART	STEEL ASTM 1045	6
PRACTICAL ACTION	OHO e.V.		LICENCE	SCALE	SHEET
			CC-BY-SA 4.0		11 / 27

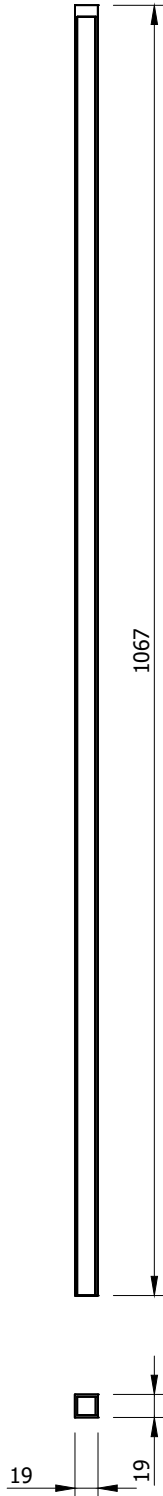

NOTE: ALL UNITS ARE IN MM

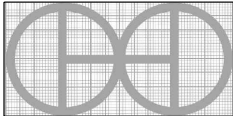
PROJECT		CREATED BY	APPROVED BY	DATE	VERSION
SIMPLE EFFECTIVE B. INCUBATOR		E. ARAUJO	A. MORILLO	01-06-21	1.0
PART NAME		FILE NAME			PART CODE
LEGS		BABY_INCUBATOR.dwg			12
DEVELOPED BY	REDESIGNED BY	SUPPORTED BY	DOC. TYPE	MATERIAL	QUANTITY
			PART	STEEL ASTM A36	4
PRACTICAL ACTION	OHO e.V.		LICENCE	SCALE	SHEET
			CC-BY-SA 4.0		12 / 27

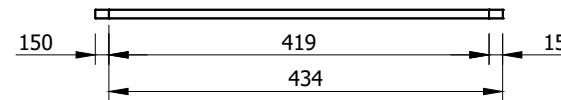
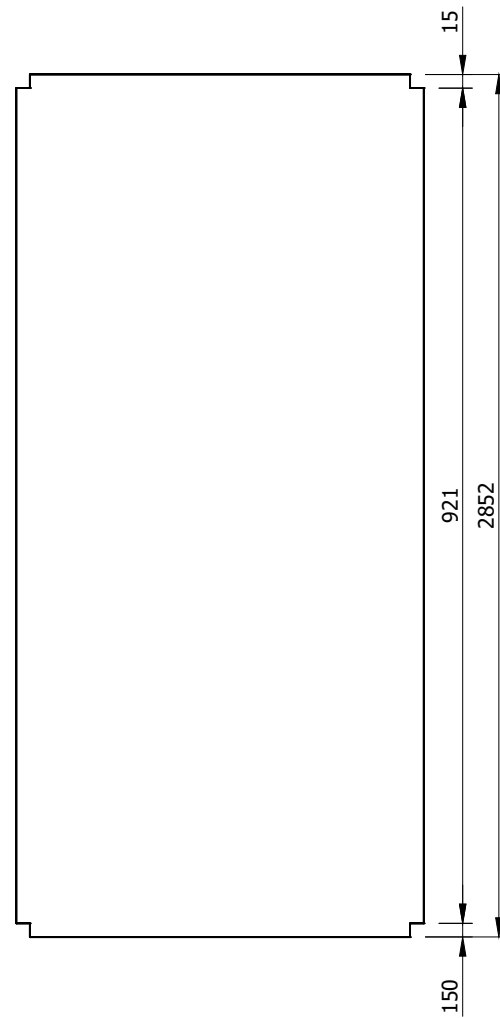
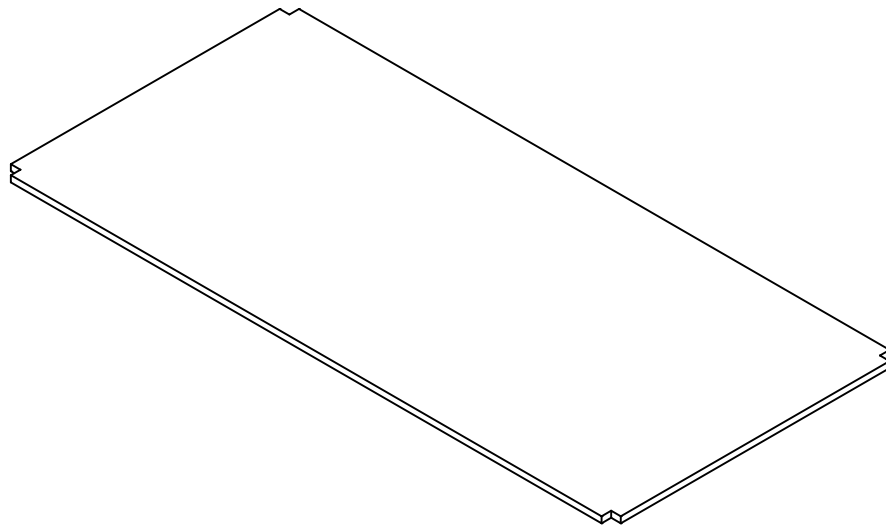

NOTE: ALL UNITS ARE IN MM

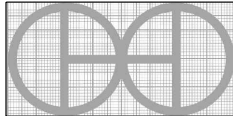
PROJECT		CREATED BY	APPROVED BY	DATE	VERSION
SIMPLE EFFECTIVE B. INCUBATOR		E. ARAUJO	A. MORILLO	01-06-21	1.0
PART NAME		FILE NAME			PART CODE
TOP AND SHELVES 1		BABY_INCUBATOR.dwg			13
DEVELOPED BY	REDESIGNED BY	SUPPORTED BY	DOC. TYPE	MATERIAL	QUANTITY
			PART	PLYWOOD 3/8"	2
PRACTICAL ACTION	OHO e.V.		LICENCE	SCALE	SHEET
			CC-BY-SA 4.0		13 / 27

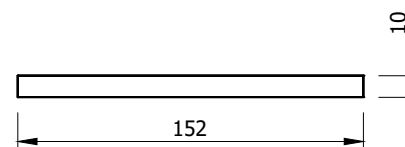
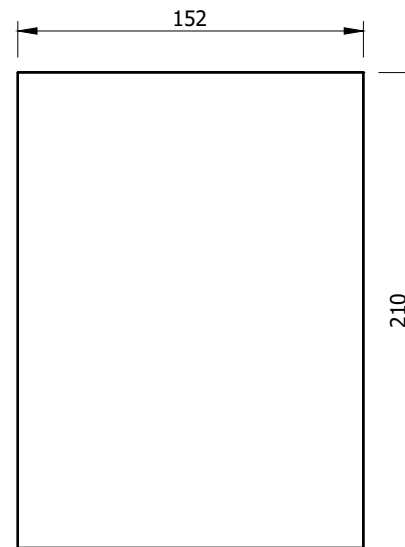
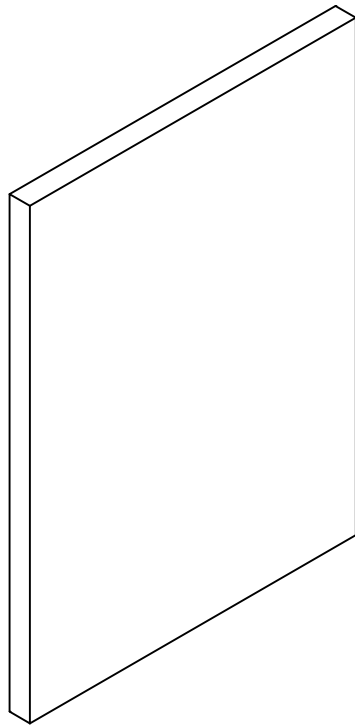

NOTE: ALL UNITS ARE IN MM

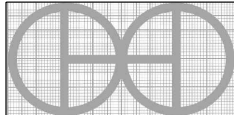
PROJECT		CREATED BY	APPROVED BY	DATE	VERSION
SIMPLE EFFECTIVE B. INCUBATOR		E. ARAUJO	A. MORILLO	01-06-21	1.0
PART NAME		FILE NAME			PART CODE
ELECTRICAL BOX FRONT		BABY_INCUBATOR.dwg			15
DEVELOPED BY	REDESIGNED BY	SUPPORTED BY	DOC. TYPE	MATERIAL	QUANTITY
			PART	PLYWOOD 3/8"	1
			LICENCE	SCALE	SHEET
PRACTICAL ACTION	OHO e.V.		CC-BY-SA 4.0		14 / 27

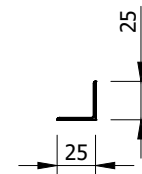
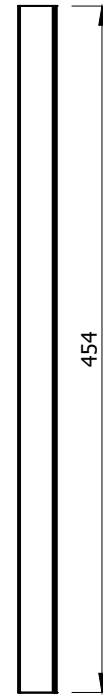
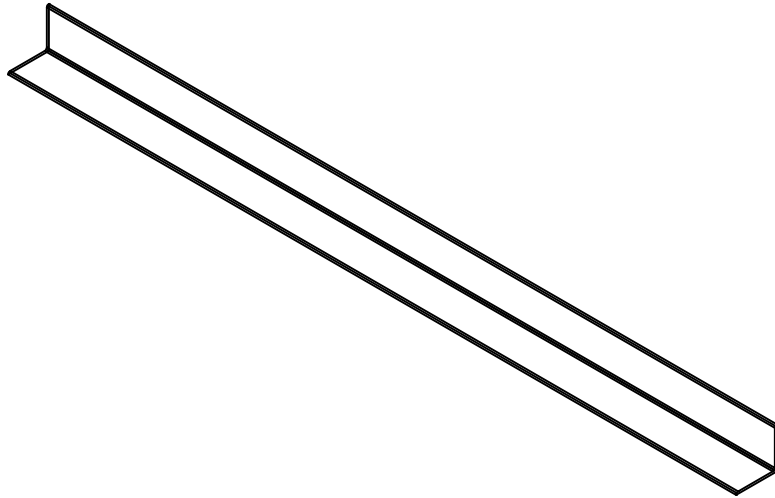

NOTE: ALL UNITS ARE IN MM

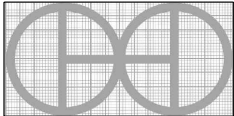
PROJECT		CREATED BY	APPROVED BY	DATE	VERSION
SIMPLE EFFECTIVE B. INCUBATOR		E. ARAUJO	A. MORILLO	01-06-21	1.0
PART NAME		FILE NAME			PART CODE
HUMIDIFIER BRACKET		BABY_INCUBATOR.dwg			16
DEVELOPED BY	REDESIGNED BY	SUPPORTED BY	DOC. TYPE	MATERIAL	QUANTITY
			PART	ALUMINIUM	2
			LICENCE	SCALE	SHEET
PRACTICAL ACTION	OHO e.V.		CC-BY-SA 4.0		15 / 27

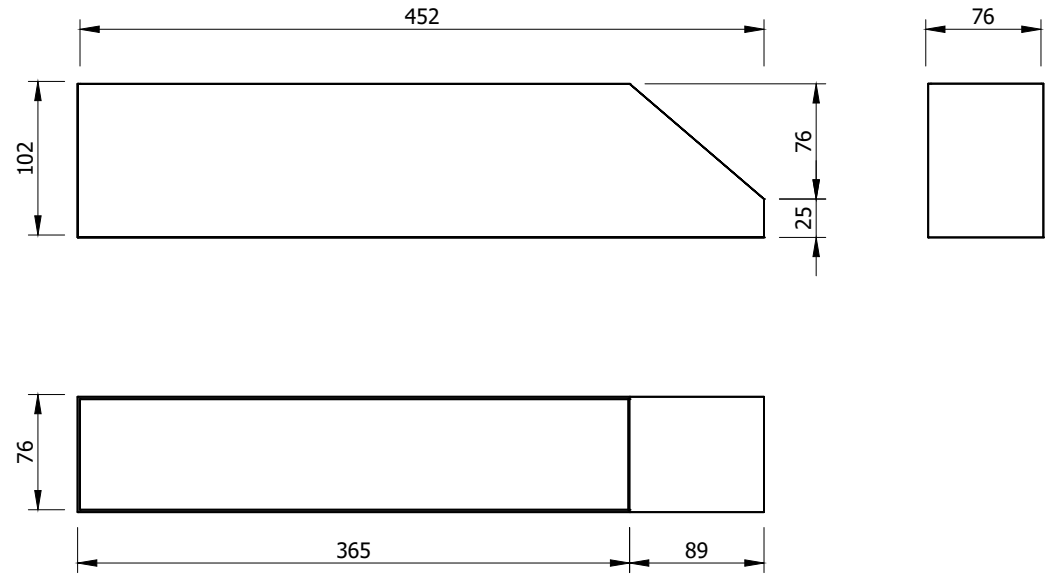
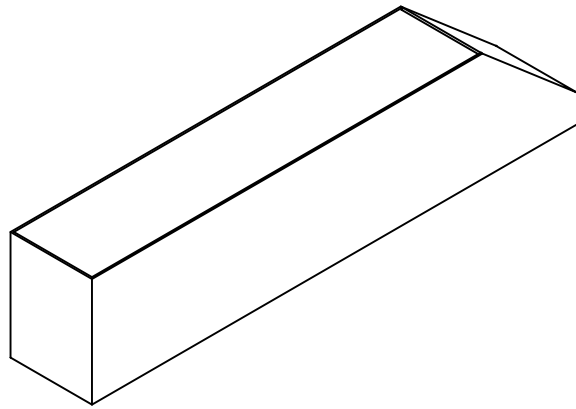

NOTE: ALL UNITS ARE IN MM

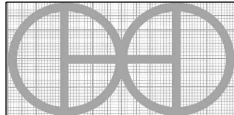
PROJECT		CREATED BY	APPROVED BY	DATE	VERSION
SIMPLE EFFECTIVE B. INCUBATOR		E. ARAUJO	A. MORILLO	01-06-21	1.0
PART NAME		FILE NAME			PART CODE
HUMIDIFIER TRAY		BABY_INCUBATOR.dwg			17
DEVELOPED BY	REDESIGNED BY	SUPPORTED BY	DOC. TYPE	MATERIAL	QUANTITY
			PART	ALUMINIUM	1
			LICENCE	SCALE	SHEET
PRACTICAL ACTION	OHO e.V.		CC-BY-SA 4.0		16 / 27

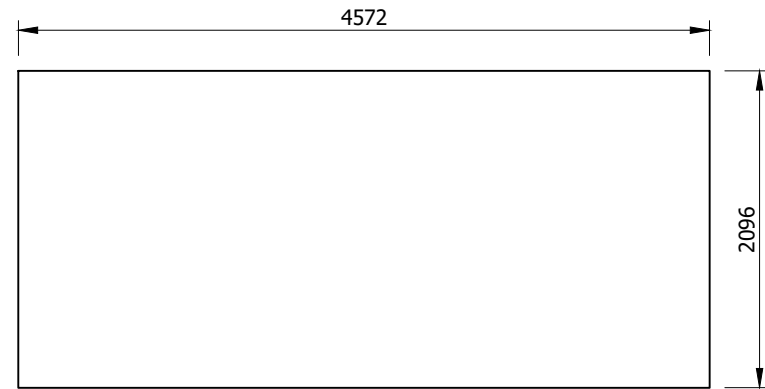
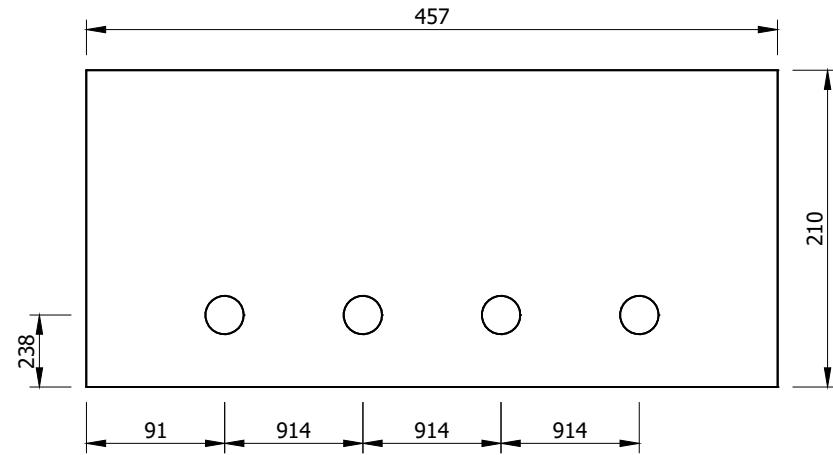
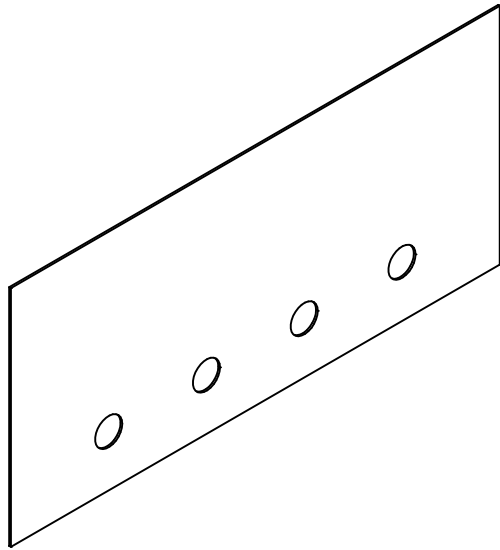

NOTE: ALL UNITS ARE IN MM

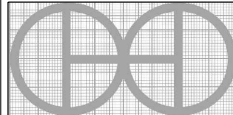
PROJECT		CREATED BY	APPROVED BY	DATE	VERSION
SIMPLE EFFECTIVE B. INCUBATOR		E. ARAUJO	A. MORILLO	01-06-21	1.0
PART NAME		FILE NAME			PART CODE
HUMIDIFIER COVER SHEET1		BABY_INCUBATOR.dwg			18
DEVELOPED BY	REDESIGNED BY	SUPPORTED BY	DOC. TYPE	MATERIAL	QUANTITY
			PART	ALUMINIUM	2
PRACTICAL ACTION	OHO e.V.		LICENCE	SCALE	SHEET
			CC-BY-SA 4.0		17 / 27

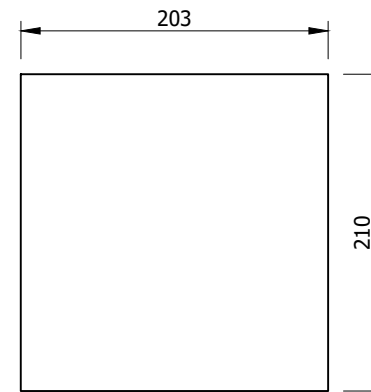
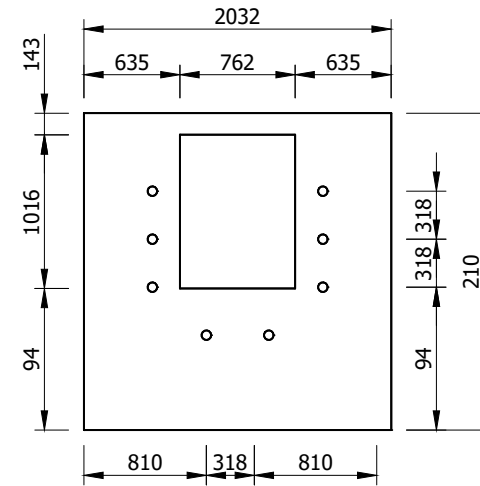
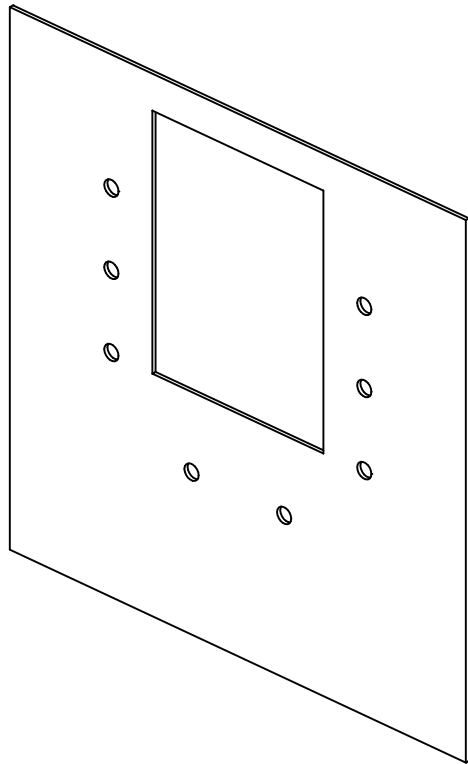

NOTE: ALL UNITS ARE IN MM

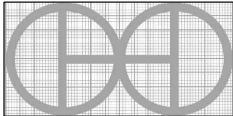
PROJECT		CREATED BY	APPROVED BY	DATE	VERSION
SIMPLE EFFECTIVE B. INCUBATOR		E. ARAUJO	A. MORILLO	01-06-21	1.0
PART NAME		FILE NAME			PART CODE
HUMIDIFIER COVER SHEET2		BABY_INCUBATOR.dwg			19
DEVELOPED BY	REDESIGNED BY	SUPPORTED BY	DOC. TYPE	MATERIAL	QUANTITY
			PART	ALUMINIUM	2
			LICENCE	SCALE	SHEET
PRACTICAL ACTION	OHO e.V.		CC-BY-SA 4.0		18 / 27

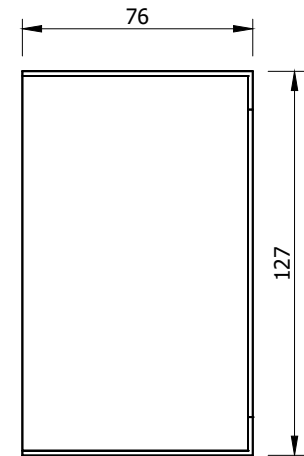
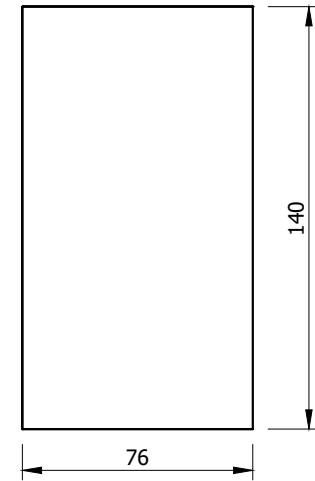
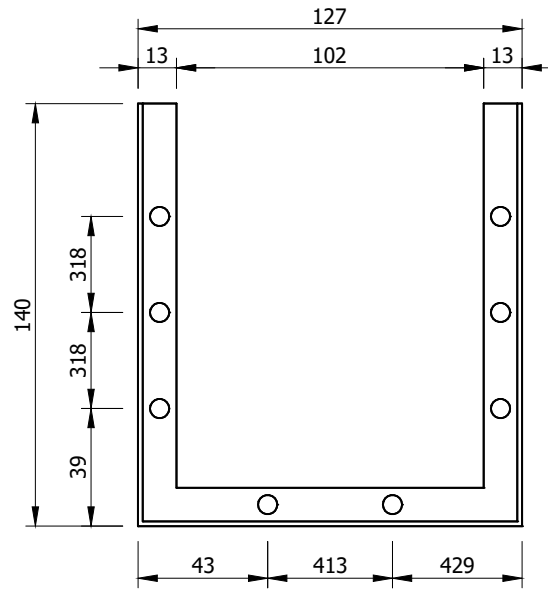
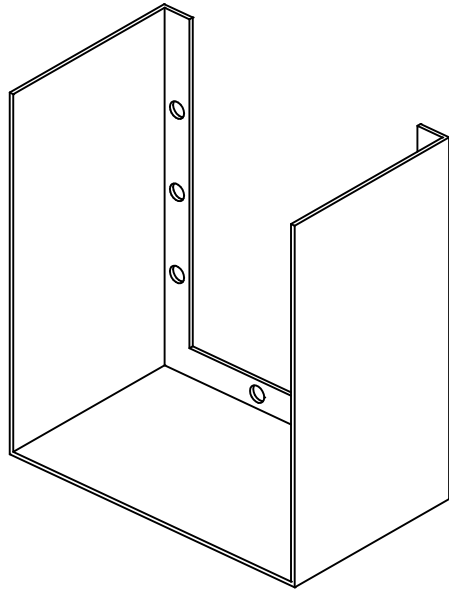

NOTE: ALL UNITS ARE IN MM

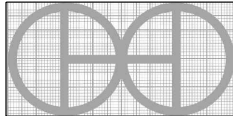
PROJECT		CREATED BY	APPROVED BY	DATE	VERSION
SIMPLE EFFECTIVE B. INCUBATOR		E. ARAUJO	A. MORILLO	01-06-21	1.0
PART NAME		FILE NAME			PART CODE
FIXED LOWER PART		BABY_INCUBATOR.dwg			20
DEVELOPED BY	REDESIGNED BY	SUPPORTED BY	DOC. TYPE	MATERIAL	QUANTITY
			PART	ALUMINIUM	1
PRACTICAL ACTION	OHO e.V.		LICENCE	SCALE	SHEET
			CC-BY-SA 4.0		19 / 27

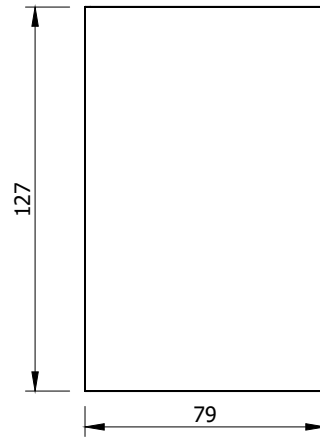
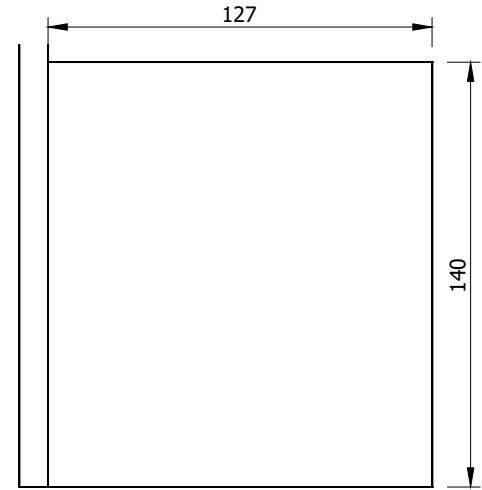
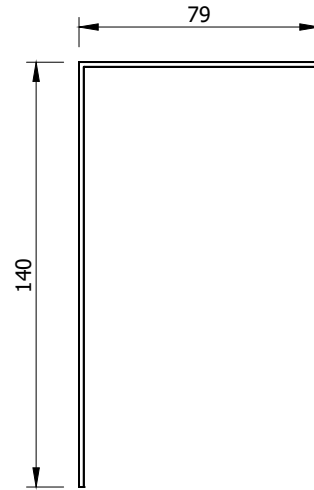
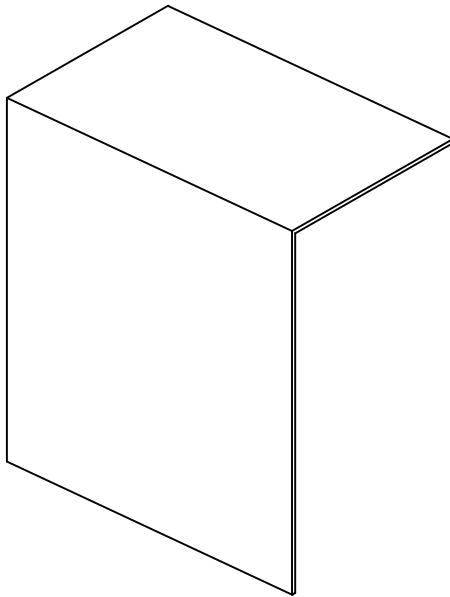

NOTE: ALL UNITS ARE IN MM

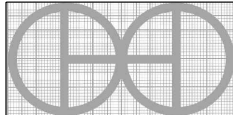
PROJECT		CREATED BY	APPROVED BY	DATE	VERSION
SIMPLE EFFECTIVE B. INCUBATOR		E. ARAUJO	A. MORILLO	01-06-21	1.0
PART NAME		FILE NAME			PART CODE
HUMIDIFIER COVER FRONT		BABY_INCUBATOR.dwg			21
DEVELOPED BY	REDESIGNED BY	SUPPORTED BY	DOC. TYPE	MATERIAL	QUANTITY
			PART	ALUMINIUM	1
PRACTICAL ACTION	OHO e.V.		LICENCE	SCALE	SHEET
			CC-BY-SA 4.0		20 / 27

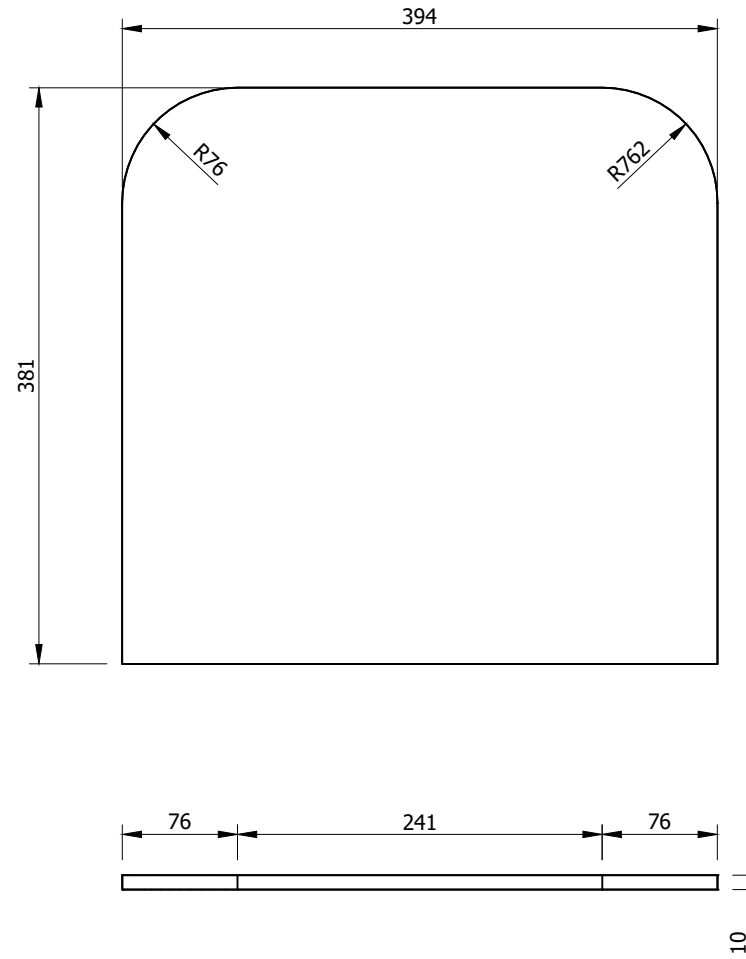
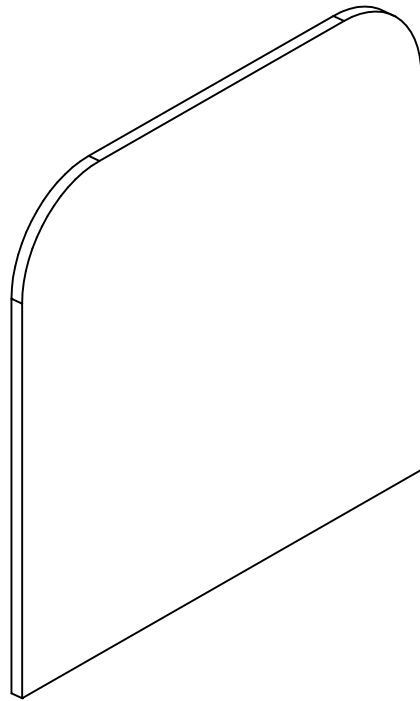

NOTE: ALL UNITS ARE IN MM

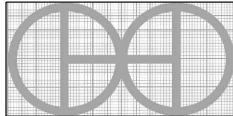
PROJECT		CREATED BY	APPROVED BY	DATE	VERSION
SIMPLE EFFECTIVE B. INCUBATOR		E. ARAUJO	A. MORILLO	01-06-21	1.0
PART NAME		FILE NAME			PART CODE
PARTITION 2		BABY_INCUBATOR.dwg			23
DEVELOPED BY	REDESIGNED BY	SUPPORTED BY	DOC. TYPE	MATERIAL	QUANTITY
			PART	PLYWOOD 3/8"	1
PRACTICAL ACTION	OHO e.V.		LICENCE	SCALE	SHEET
			CC-BY-SA 4.0		21 / 27

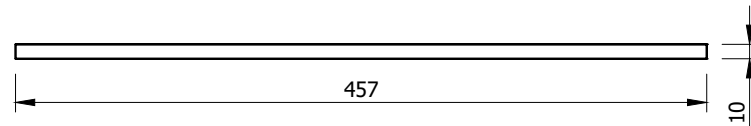
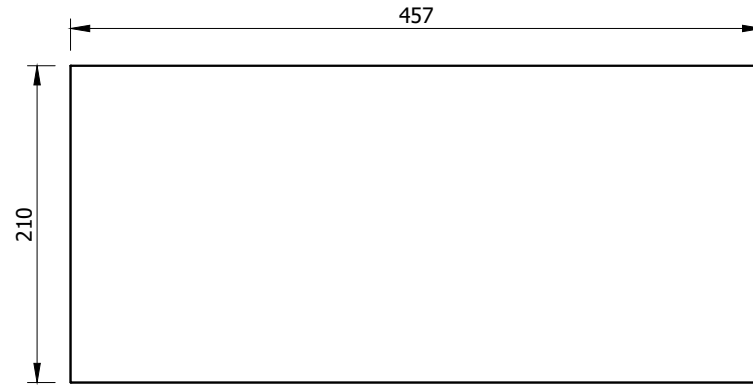
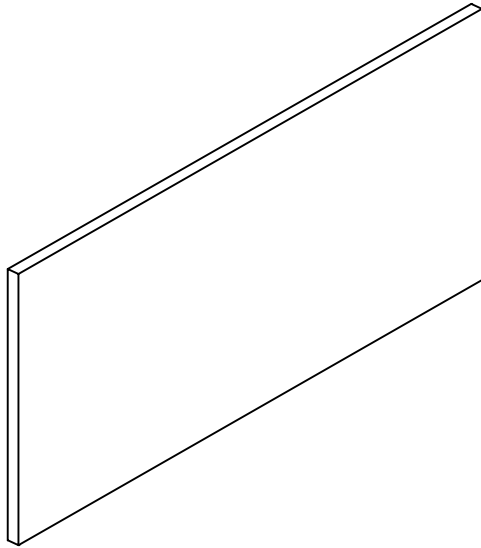

NOTE: ALL UNITS ARE IN MM

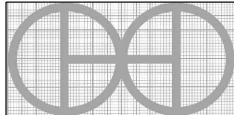
PROJECT		CREATED BY	APPROVED BY	DATE	VERSION
SIMPLE EFFECTIVE B. INCUBATOR		E. ARAUJO	A. MORILLO	01-06-21	1.0
PART NAME		FILE NAME			PART CODE
ELECTRICAL BOX LATERAL		BABY_INCUBATOR.dwg			24
DEVELOPED BY	REDESIGNED BY	SUPPORTED BY	DOC. TYPE	MATERIAL	QUANTITY
			PART	PLYWOOD 3/8"	1
PRACTICAL ACTION	OHO e.V.		LICENCE	SCALE	SHEET
			CC-BY-SA 4.0		22 / 27

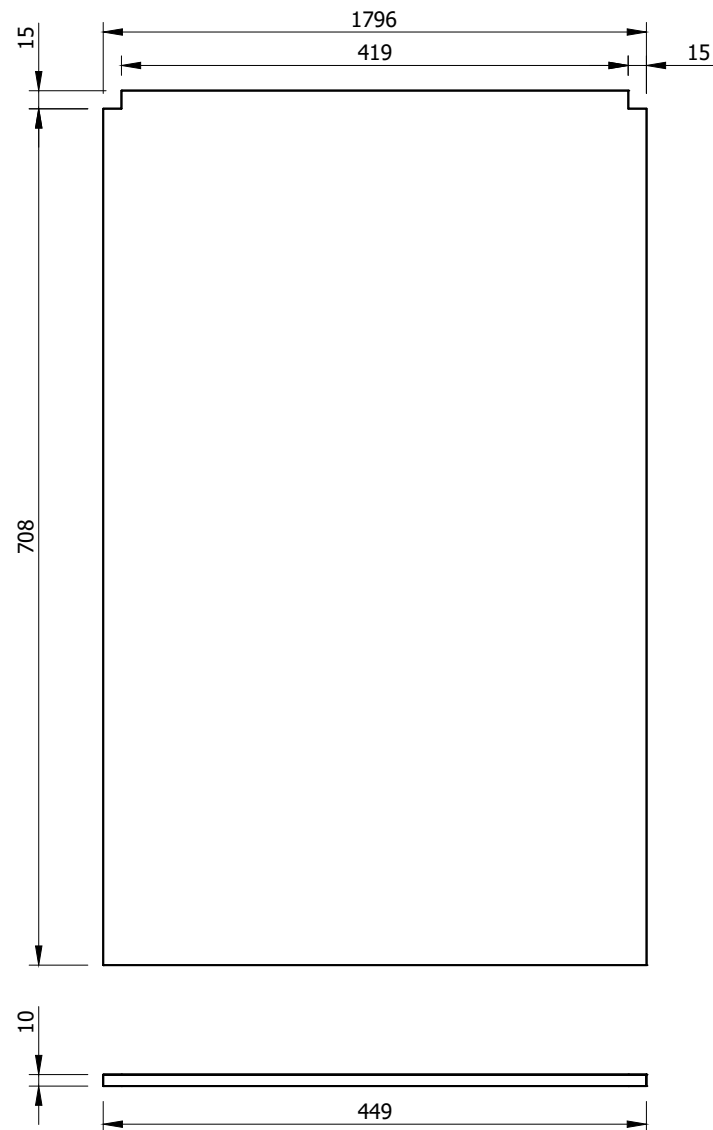
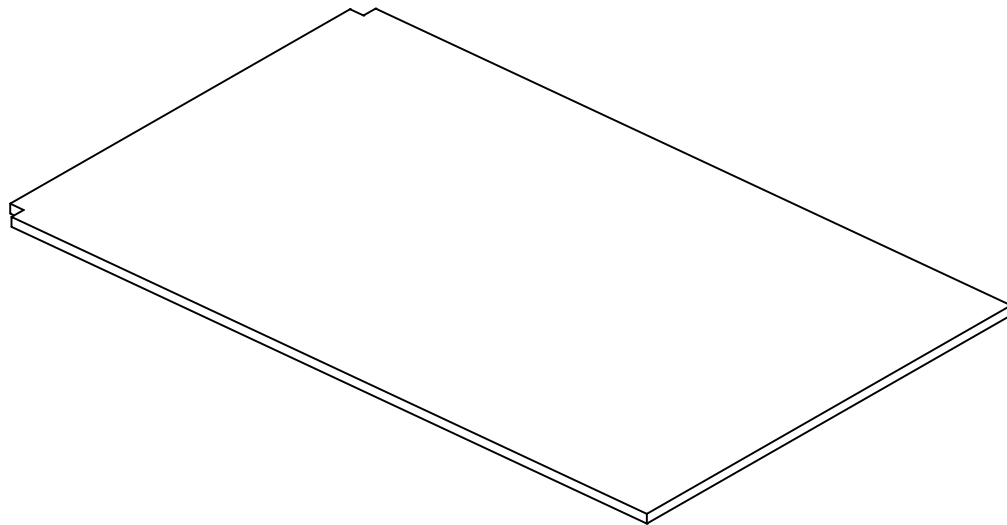

NOTE: ALL UNITS ARE IN MM

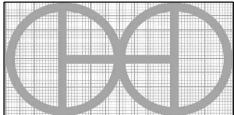
PROJECT		CREATED BY	APPROVED BY	DATE	VERSION
SIMPLE EFFECTIVE B. INCUBATOR		E. ARAUJO	A. MORILLO	01-06-21	1.0
PART NAME		FILE NAME			PART CODE
TOP AND SHELVES 2		BABY_INCUBATOR.dwg			25
DEVELOPED BY	REDESIGNED BY	SUPPORTED BY	DOC. TYPE	MATERIAL	QUANTITY
			PART	PLYWOOD 3/8"	1
			LICENCE	SCALE	SHEET
PRACTICAL ACTION	OHO e.V.		CC-BY-SA 4.0		23 / 27

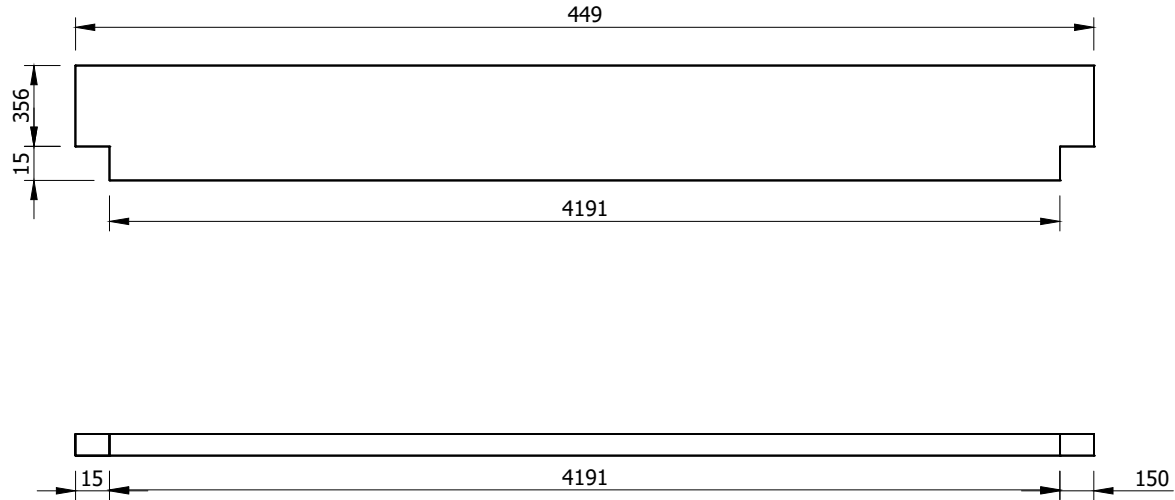
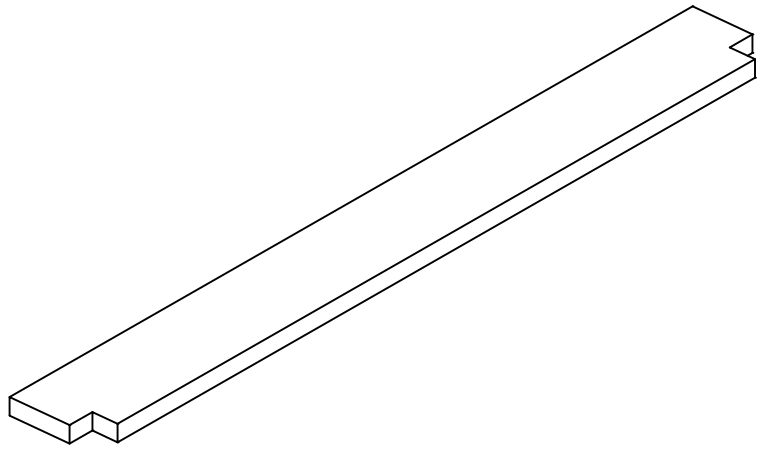

NOTE: ALL UNITS ARE IN MM

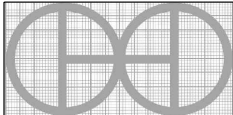
PROJECT		CREATED BY	APPROVED BY	DATE	VERSION
SIMPLE EFFECTIVE B. INCUBATOR		E. ARAUJO	A. MORILLO	01-06-21	1.0
PART NAME		FILE NAME			PART CODE
TOP AND SHELVES 3		BABY_INCUBATOR.dwg			26
DEVELOPED BY	REDESIGNED BY	SUPPORTED BY	DOC. TYPE	MATERIAL	QUANTITY
			PART	PLYWOOD 3/8"	1
PRACTICAL ACTION	OHO e.V.		LICENCE	SCALE	SHEET
			CC-BY-SA 4.0		24 / 27

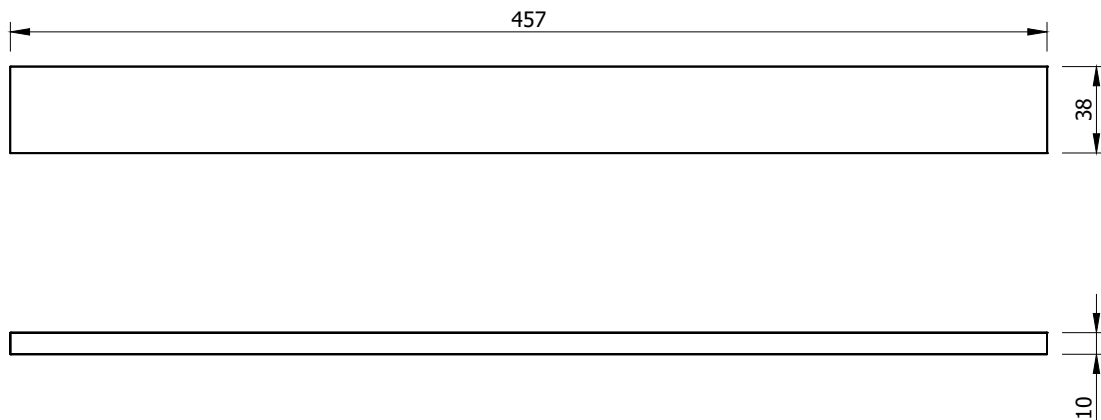
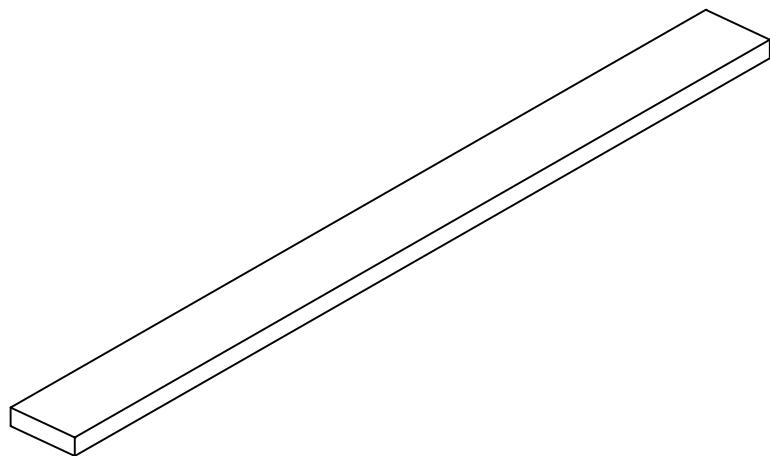

NOTE: ALL UNITS ARE IN MM

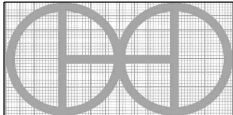
PROJECT		CREATED BY	APPROVED BY	DATE	VERSION
SIMPLE EFFECTIVE B. INCUBATOR		E. ARAUJO	A. MORILLO	01-06-21	1.0
PART NAME		FILE NAME			PART CODE
ELECTRICAL BOX EDGE 1		BABY_INCUBATOR.dwg			27
DEVELOPED BY	REDESIGNED BY	SUPPORTED BY	DOC. TYPE	MATERIAL	QUANTITY
			PART	PLYWOOD 3/8"	2
			LICENCE	SCALE	SHEET
PRACTICAL ACTION	OHO e.V.		CC-BY-SA 4.0		25 / 27

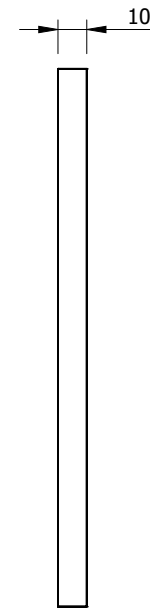
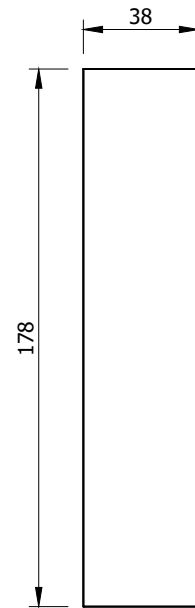
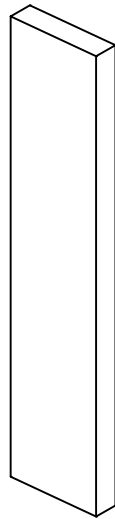

NOTE: ALL UNITS ARE IN MM

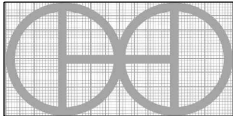
PROJECT		CREATED BY	APPROVED BY	DATE	VERSION
SIMPLE EFFECTIVE B. INCUBATOR		E. ARAUJO	A. MORILLO	01-06-21	1.0
PART NAME		FILE NAME			PART CODE
ELECTRICAL BOX EDGE 2		BABY_INCUBATOR.dwg			28
DEVELOPED BY	REDESIGNED BY	SUPPORTED BY	DOC. TYPE	MATERIAL	QUANTITY
			PART	PLYWOOD 3/8"	2
PRACTICAL ACTION	OHO e.V.		LICENCE	SCALE	SHEET
			CC-BY-SA 4.0		26 / 27

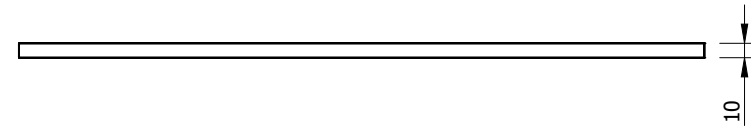
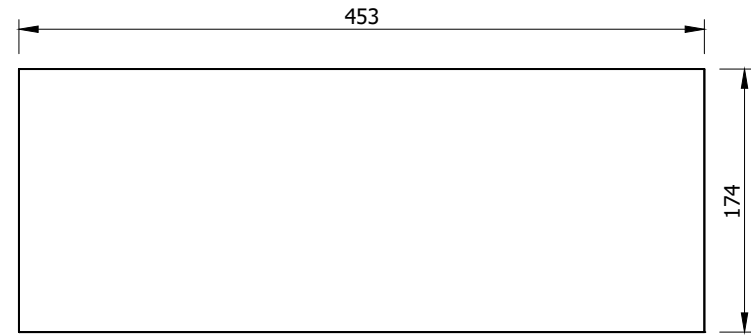
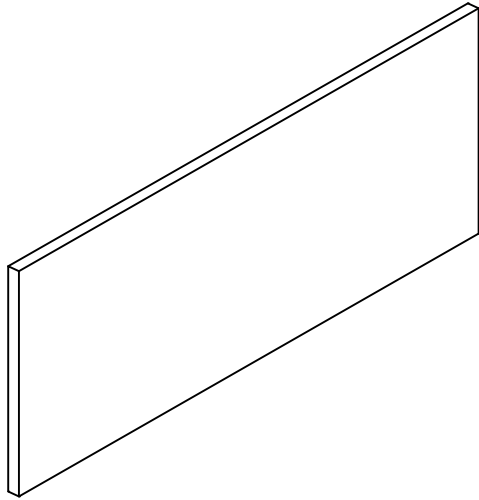

NOTE: ALL UNITS ARE IN MM

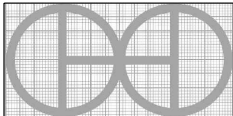
PROJECT		CREATED BY	APPROVED BY	DATE	VERSION
SIMPLE EFFECTIVE B. INCUBATOR		E. ARAUJO	A. MORILLO	01-06-21	1.0
PART NAME		FILE NAME			PART CODE
ELECTRICAL BOX SHEET		BABY_INCUBATOR.dwg			29
DEVELOPED BY	REDESIGNED BY	SUPPORTED BY	DOC. TYPE	MATERIAL	QUANTITY
			PART	PLYWOOD 3/8"	1
PRACTICAL ACTION	OHO e.V.		LICENCE	SCALE	SHEET
			CC-BY-SA 4.0		27 / 27