

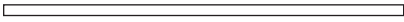
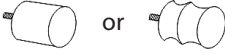

west elm : wood rod (thin and 2")

mounting instructions

NOTE:

- Stud mounting is recommended. Use proper hardware for your wall type (such as anchors for drywall). When in doubt, consult your local hardware store.

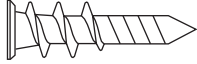
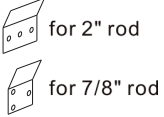
 <p>rod 1x for 4' and 6' rod, 2x for 8' rod</p>	 <p>finials 2x</p>	 <p>mounting bracket 2x for 4' rod, 3x for 6' and 8' rod</p>
 <p>screw 6x for 4' rod, 9x for 6' and 8' rod</p>	 <p>anchor 6x for 4' rod, 9x for 6' and 8' rod</p>	 <p>back plate 2x for 4' rod, 3x for 6' and 8' rod</p>

Mounting Instructions:

1. Determine the location of the brackets on the wall. Using a pencil, mark the location of the screw holes. This is where the hardware will be inserted. Remove from wall.
2. Mount rod onto the wall following instructions for your wall type:

Dry Wall Mounting:

- Use a Phillips screwdriver to insert the wall anchors. Do not "push" or drive the anchor into the wall, it is designed to bore into the wall like a drill bit. Slowly turn the anchor clockwise while applying pressure until the flange just touches the wall.
- Insert screw into the anchor turning clockwise so the bracket is snug against the wall.

Stud Mounting:

- Using a Phillips screwdriver (or drill) insert metal screws into the stud tightening in a clockwise direction so the bracket fits snugly against the wall.

3. Place rings (sold separately) onto rod and then set the rod onto mounted brackets.
4. Attach finials.

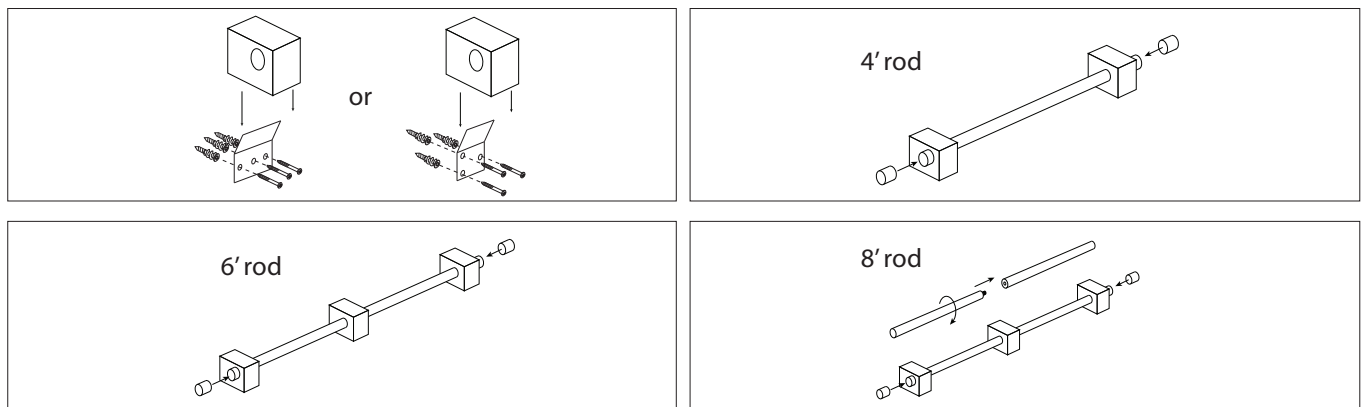

CARE INSTRUCTIONS:

- Wipe with a soft, dry or slightly damp cloth. To protect the finish, do not apply household cleaners or abrasives.