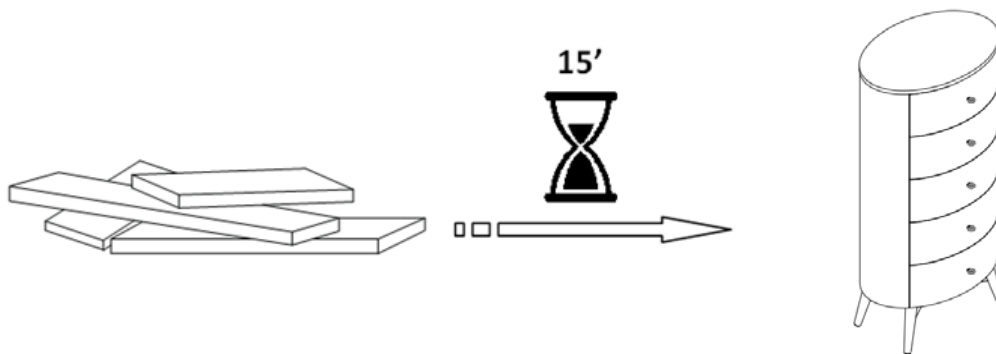

**Penelope Narrow 5-Drawer Dresser**  
**CMMD 5TIR PENELOPE BS/MRBR A**  
**CÓMODA 5 CAJ. PENELOPE MAD/MÁRMOL A**

**⚠ ENGLISH**

- Do not dispose of any packaging or contents of the shipping carton until assembly is completed to avoid accidentally discarding small parts or hardware.

**⚠ FRANÇAIS**

- Ne jetez rien des produits d'emballage et du contenu de la boîte jusqu'à ce que l'assemblage soit terminé, afin d'éviter de jeter par mégarde de petites pièces ou des morceaux.

**⚠ ESPAÑOL**

- Para evitar desechar accidentalmente las partes pequeñas o las piezas de ferretería, no tirar el embalaje o contenido de la caja hasta que el ensamblaje esté completo.

**Care Instructions:**

- Dust often using a clean, soft, dry and lint-free cloth.
- When blot spills, wipe with a clean, damp cloth immediately.
- We do not recommend the use of chemical cleansers, abrasives or furniture polish on our lacquered finish.
- Hardware may loosen over time. Periodically check to make sure all connections are tight. Re-tighten if necessary.

**Instructions d'entretien :**

- Épousseter régulièrement avec un chiffon propre, doux et non pelucheux.
- Éponger immédiatement les liquides renversés et essuyer à l'aide d'un chiffon propre et humide.
- L'utilisation de produits nettoyants chimiques, d'abrasifs ou d'encaustiques sur nos finitions laquées n'est pas recommandée.
- Le matériel de fixation peut se desserrer avec le temps. Vérifiez régulièrement afin de vous assurer que tous les raccords sont bien serrés. Resserrez-les au besoin.

**Instrucciones de cuidado:**

- Limpiar el polvo con un trapo limpio, suave, seco y libre de pelusas.
- Secar los derrames de inmediato y limpiar con un trapo limpio y húmedo.
- Recomendamos no usar limpiadores químicos, abrasivos o lustramuebles sobre el acabado barnizado.
- Las piezas de ferretería pueden aflojarse con el tiempo. Controlar periódicamente que estén bien ajustadas. Si es necesario, volver a ajustarlas.

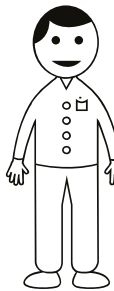



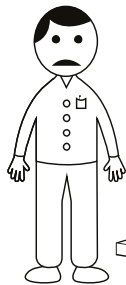
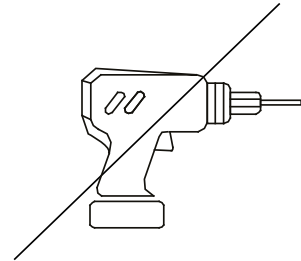
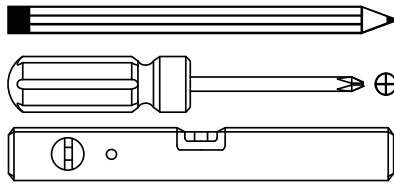



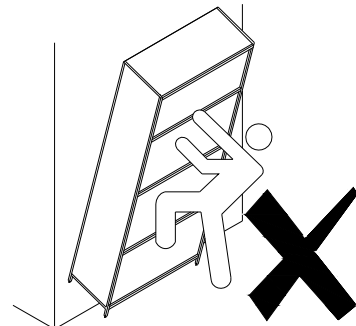
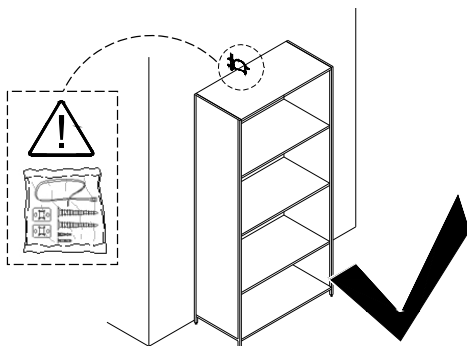
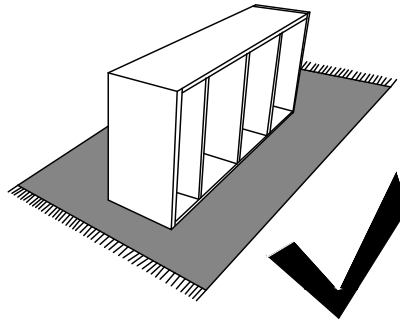
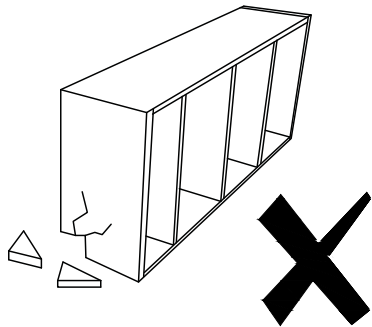
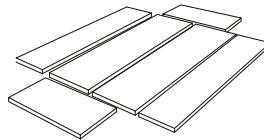
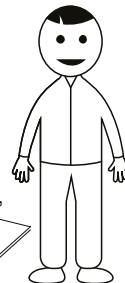
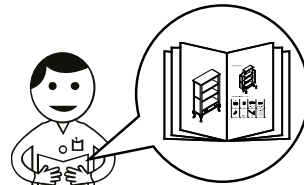
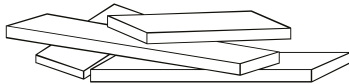
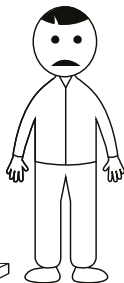

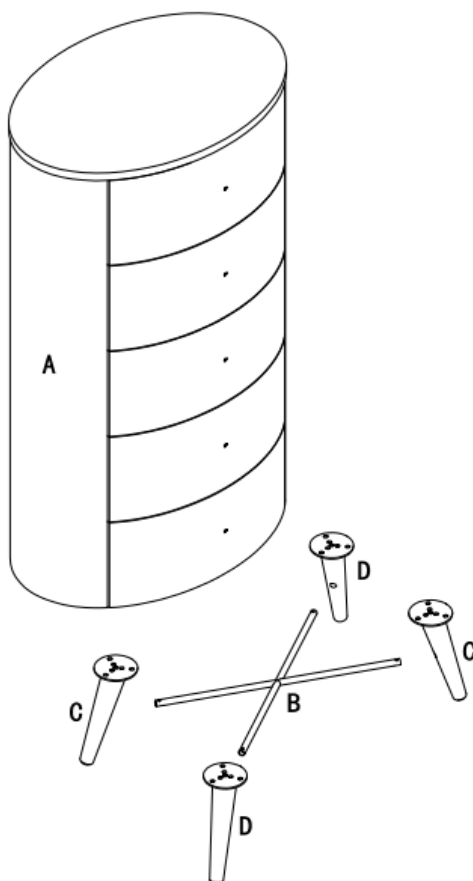
**X2**



?





- |   |   |   |   |   |   |
|---|---|---|---|---|---|
| <b>E</b>  | <b>F</b>  | <b>G</b>  | <b>H</b>  | <b>I</b>  | <b>J</b>  |
|  |  |  |  |  |  |
| 12X   | 12X   | 8# × 3/4"<br>4X   | 5/32" × 3/4"<br>5X  | 1/4" × 3/4"<br>12X  | 5X  |
- 
- |   |   |
|---|---|
| <b>K</b>  | <b>L</b>  |
|  |    |
| 1X  | <ul style="list-style-type: none"> <li>● Anti-tip kit /</li> <li>● <u>Dispositif anti-basculement/</u></li> <li>● <u>Kit anti-volcada</u></li> </ul> 1X |

## 1

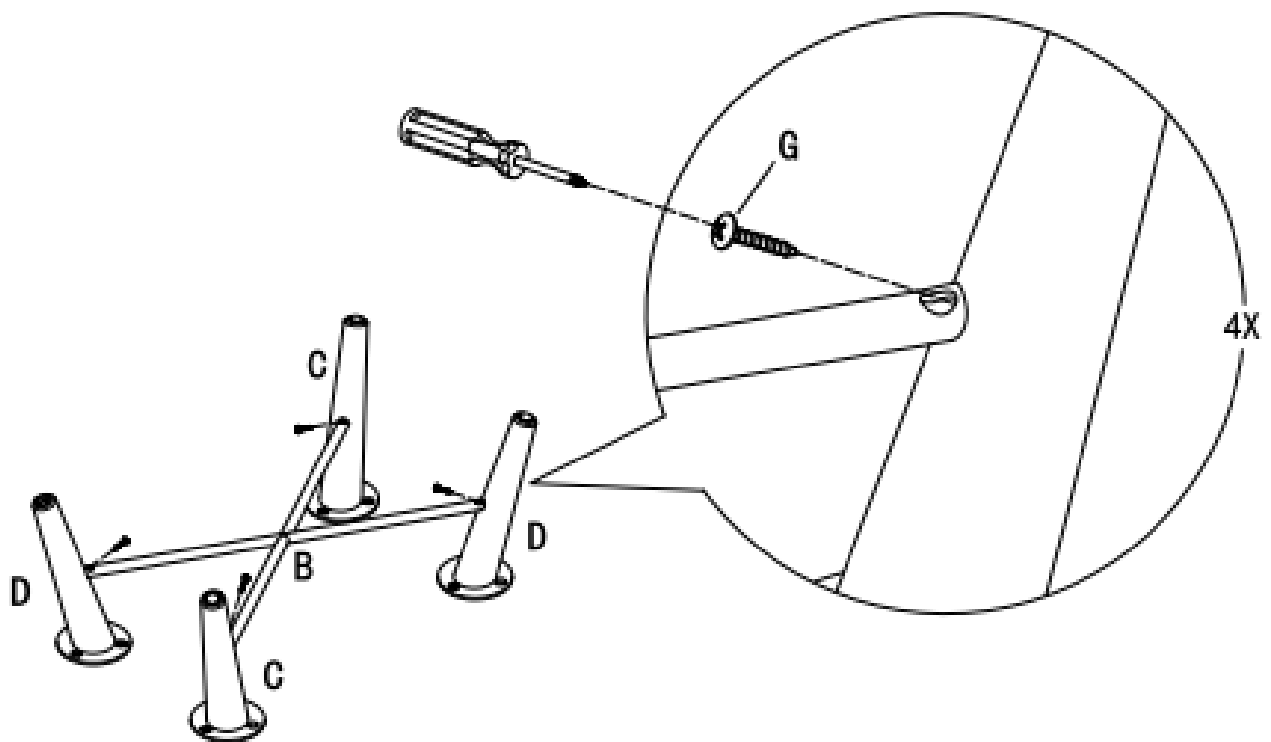

## 2

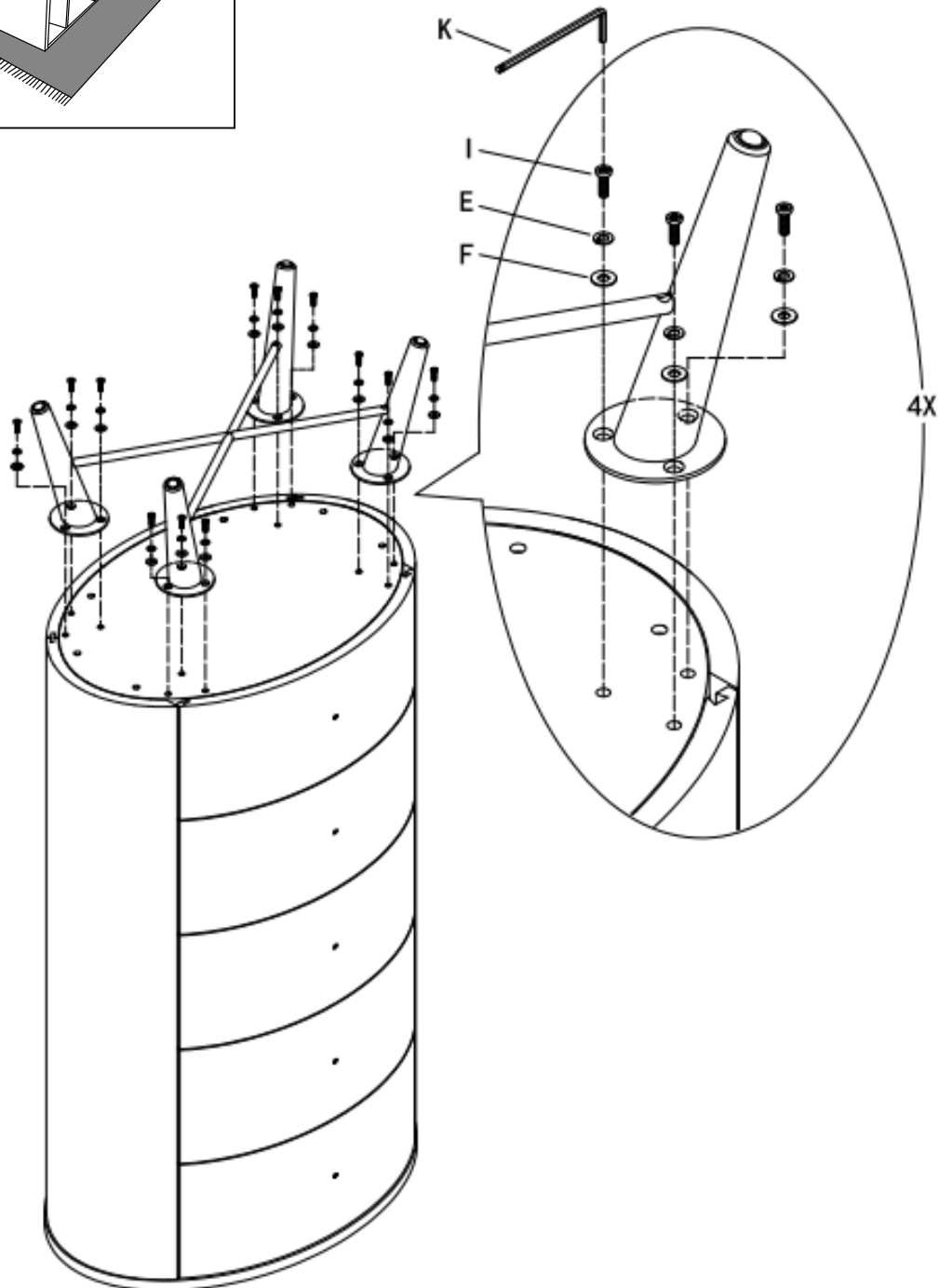
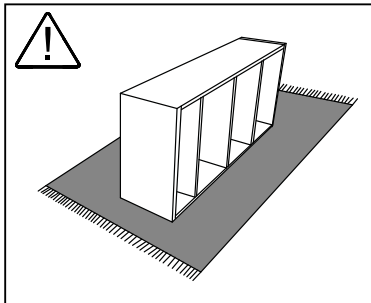

## 3

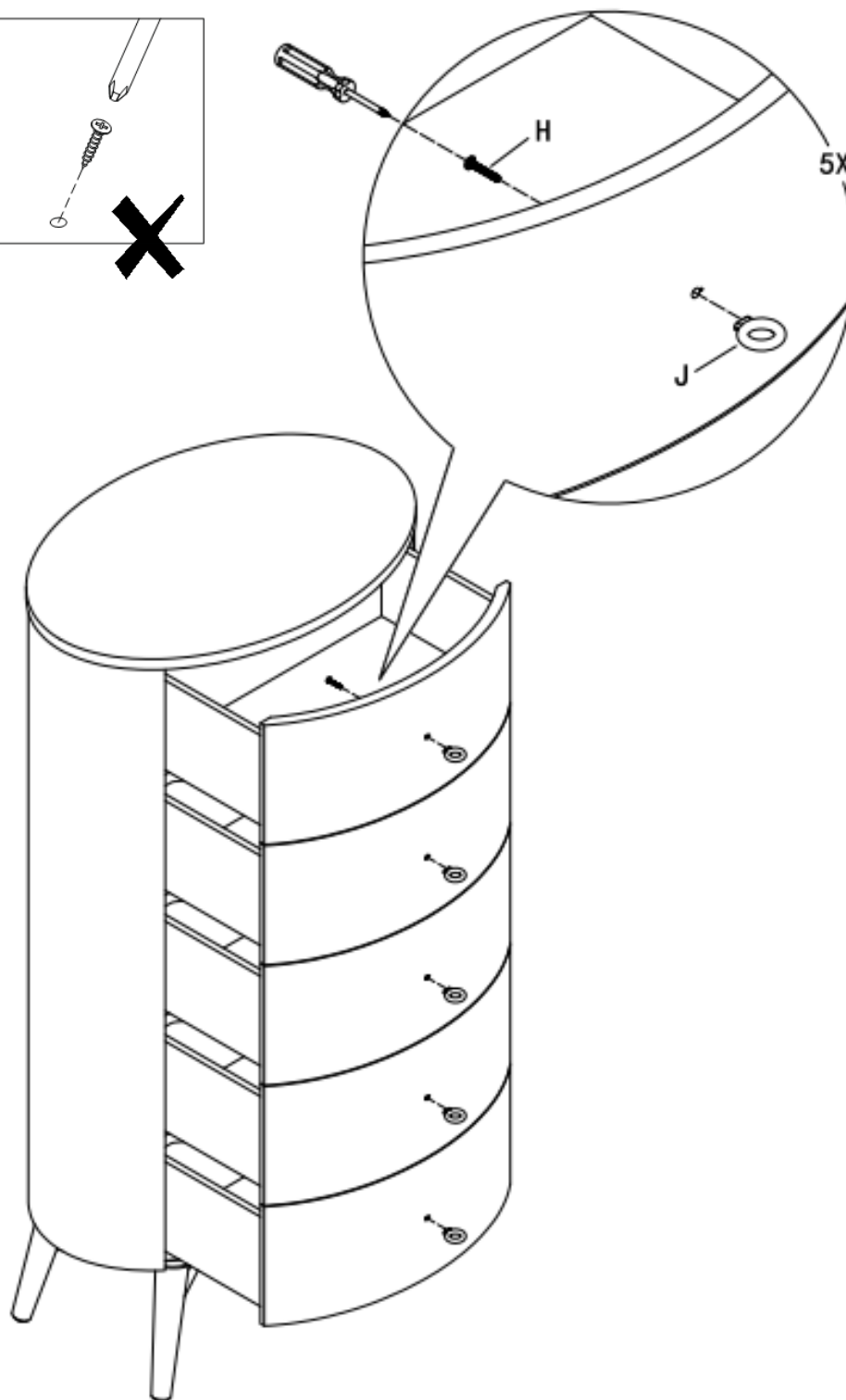
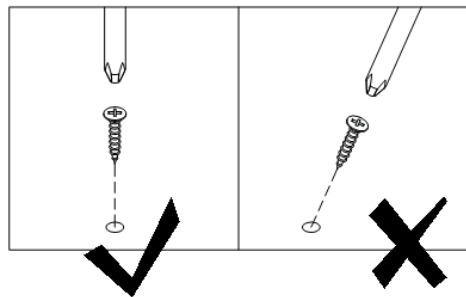

## 4

