

! Tools supplied:

! Do not throw away packaging materials until assembly is complete.

! Assemble this item on a soft surface, such as cardboard or carpet, to protect finish.

! Proper assembly of this item requires 2 people.

Parts

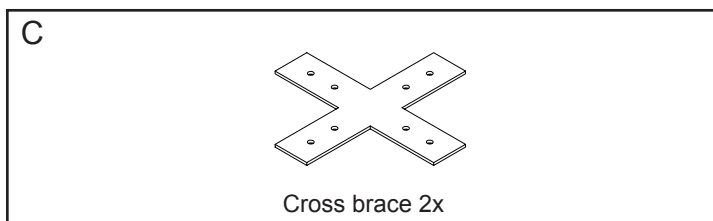
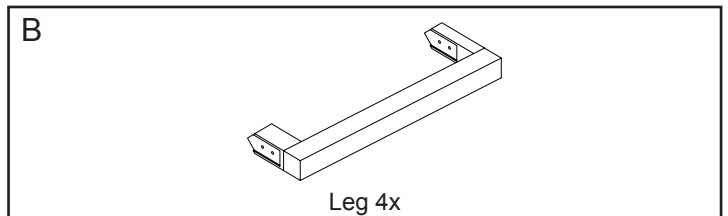
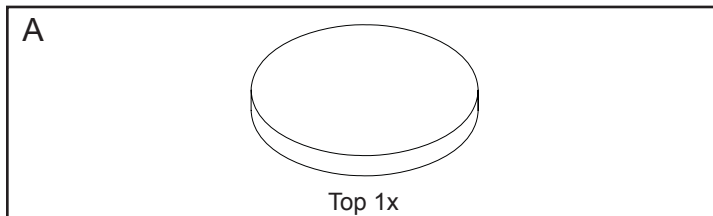

Hardware

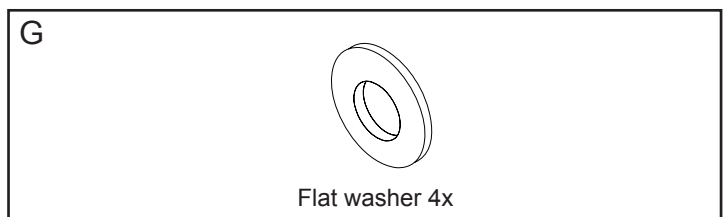
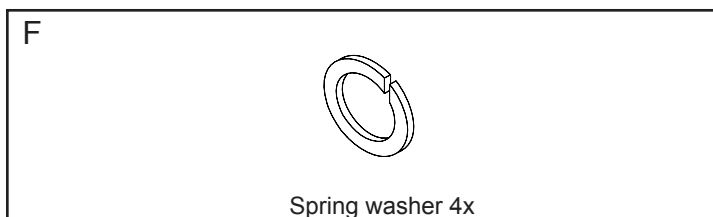
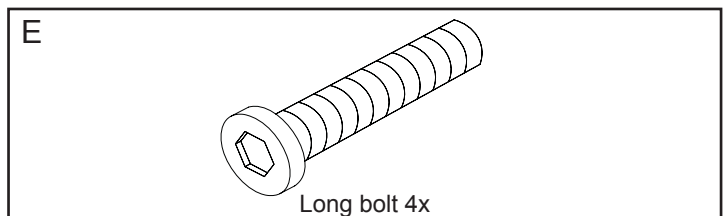
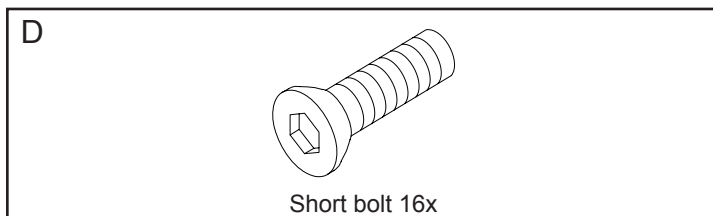

1. Align 4 legs (B) so that the points all come together in the center like the drawing shows. Place 1 cross brace (C) into routes in top section and 1 cross brace (C) into routes in bottom section. Insert 1 short bolt into each of the 16 holes in the cross braces. Tighten with supplied allen key.

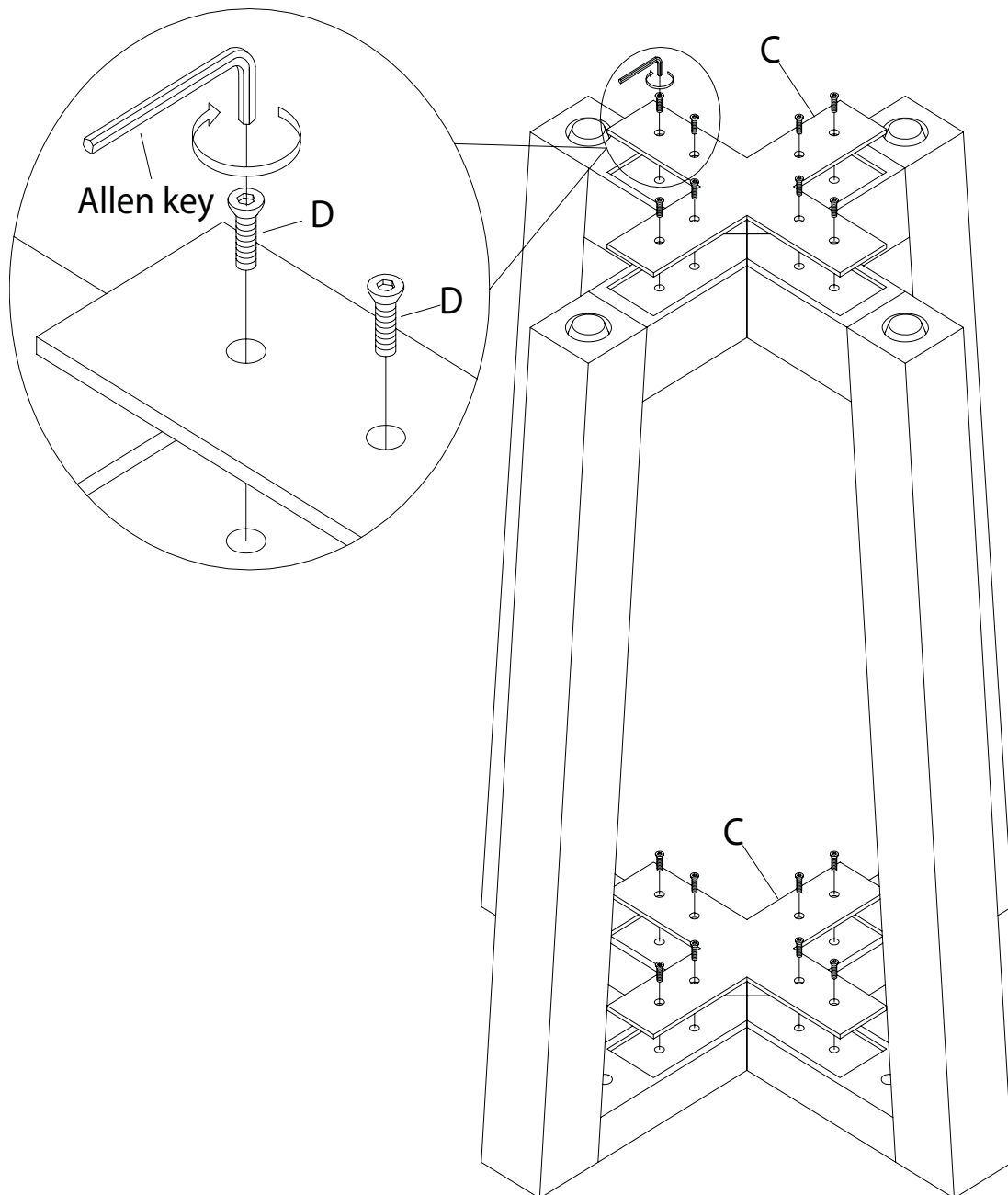

2. Lay top face down with the holes pointed upward. Next place assembled legs (B) with cross braces (C) onto top. Align holes from legs to top. Insert 1 long bolt (E) through 1 spring washer (F) and 1 flat washer (G). Insert this bolt assembly into hole in leg assembly as shown. Repeat for all four holes. After all 4 bolts have been tightened flip the table over.

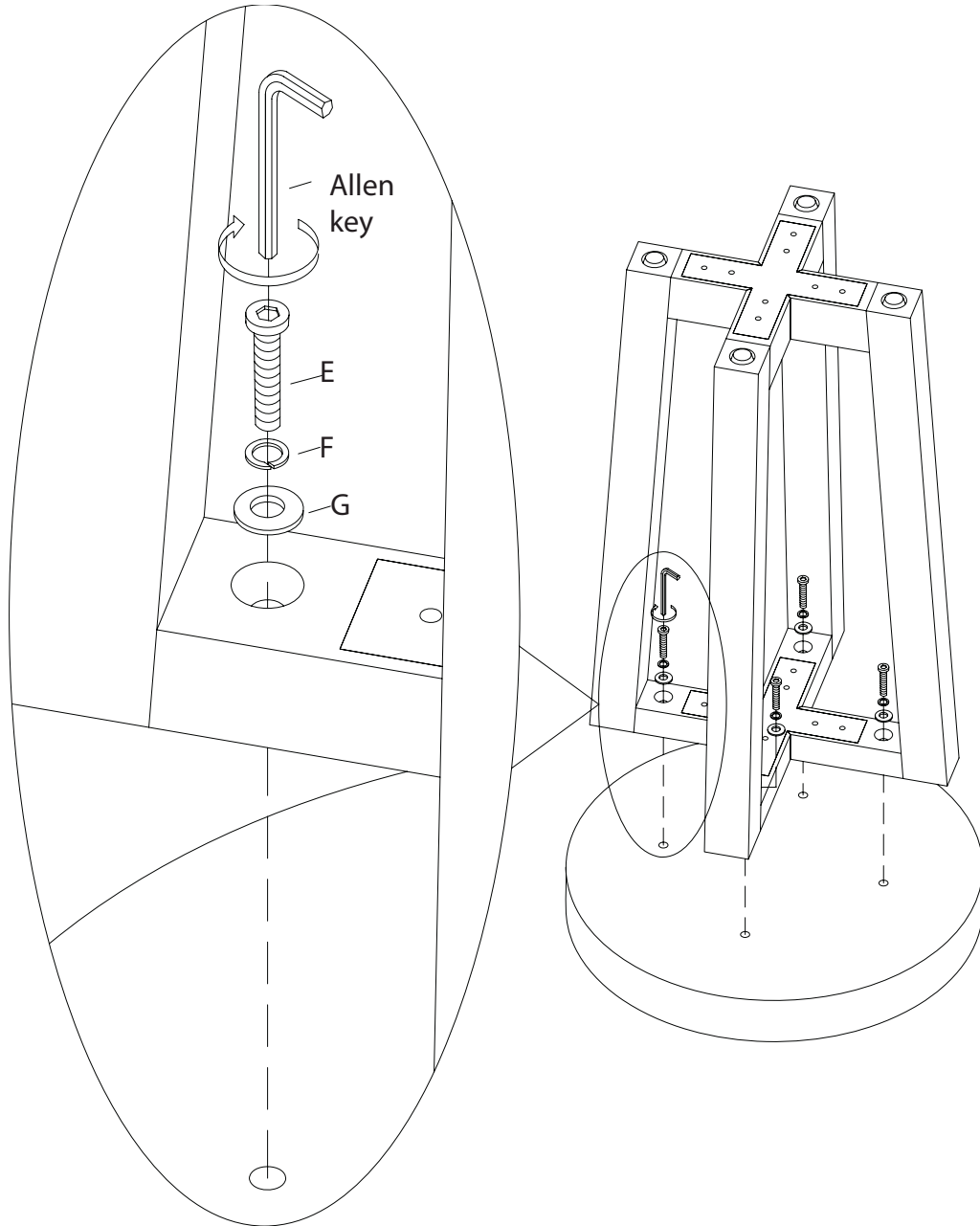

CARE INSTRUCTIONS

Hardware may loosen overtime. Periodically check that all connections are tight.

Wipe with a soft, dry cloth. To protect finish, avoid the use of chemicals and household cleaners.