

Metal Pivot Mirror – Rectangle

ENGLISH

- Do not dispose of any packaging or contents of the shipping carton until assembly is completed to avoid accidentally discarding small parts or hardware.

FRANÇAIS

- Ne jetez rien des produits d'emballage et du contenu de la boîte jusqu'à ce que l'assemblage soit terminé, afin d'éviter de jeter par mégarde de petites pièces ou des morceaux.

ESPAÑOL

- Para evitar desechar accidentalmente las partes pequeñas o las piezas de ferretería, no tirar el embalaje o contenido de la caja hasta que el ensamblaje esté completo.

Care Instructions:

- Dust often using a clean, soft, dry and lint-free cloth.
- Blot spills and wipe with a clean, damp cloth immediately.
- We do not recommend the use of chemical cleansers, abrasives or furniture polish on our lacquered finish.
- Hardware may loosen over time. Periodically check to make sure all connections are tight. Re-tighten if necessary.

Instructions d'entretien :

- Éponser régulièrement avec un chiffon propre, doux et non pelucheux.
- Éponger immédiatement les liquides renversés et essuyer à l'aide d'un chiffon propre et humide.
- L'utilisation de produits nettoyants chimiques, d'abrasifs ou d'encaustiques sur nos finitions laquées n'est pas recommandée.
- Le matériel de fixation peut se desserrer avec le temps. Vérifiez régulièrement afin de vous assurer que tous les raccords sont bien serrés. Resserrez-les au besoin.

Instrucciones de cuidado:

- Limpiar el polvo con un trapo limpio, suave, seco y libre de pelusas.
- Secar los derrames de inmediato y limpiar con un trapo limpio y húmedo.
- Recomendamos no usar limpiadores químicos, abrasivos o lustramuebles sobre el acabado barnizado.
- Las piezas de ferretería pueden aflojarse con el tiempo. Controlar periódicamente que estén bien ajustadas. Si es necesario, volver a ajustarlas.

Note : The hardware provided is meant for dry wall/ stud / wood wall mounting only . Please consult your local hardware store for proper fasteners if your wall is not wood. .

Remarque : le matériel fourni est destiné uniquement à un montage mural ou sur montant. Consulter la quincaillerie locale pour les fixations appropriées si le mur n'est pas fabriquée en bois.

Nota: Las piezas de ferretería que se proporcionan se deben utilizar para montaje en viga, cartón de yeso o pared de madera únicamente. Consulte en su ferretería local para obtener los sujetadores apropiados en caso de que su pared no sea de madera.

WARNING ! DO NOT MOUNT THIS ITEM ABOVE CRIBS, BEDS or CHANGING TABLES.

ATTENTION ! NE PAS MONTER CET ARTICLE AU-DESSUS DES CRIBS, DES LITS OU DESTABLES À CHANGER.

ADVERTENCIA ! NO MONTE ESTE ARTÍCULO SOBRE LAS CUNAS, CAMAS O CAMBIOS DEMESAS.

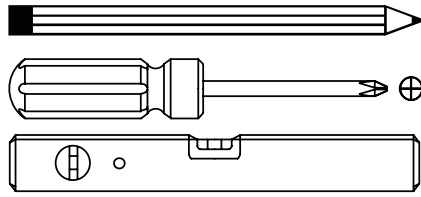
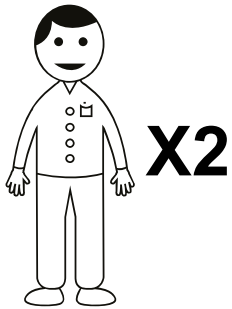

NOT INCLUDED / NON INCLUS / NO INCLUIDAS

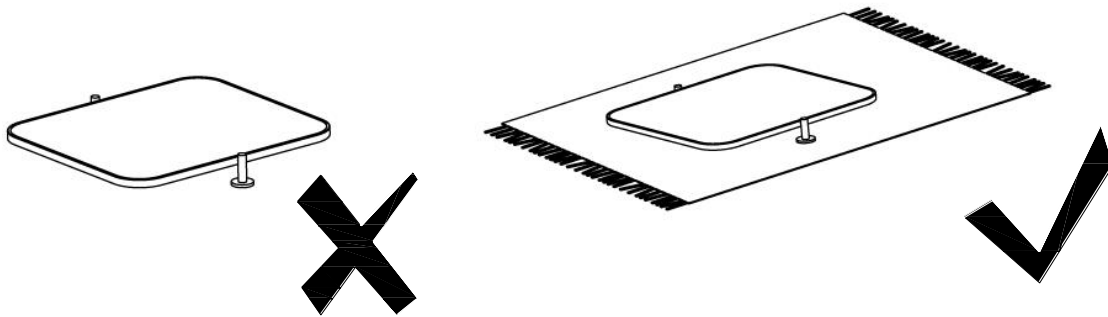
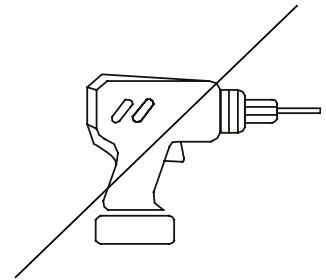

Parts Included:

Pièces incluses:

Piezas incluidas:

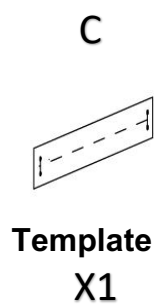

Shipped separately:

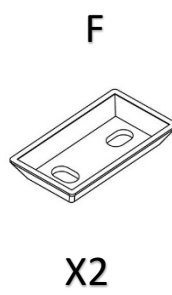
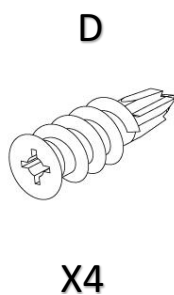
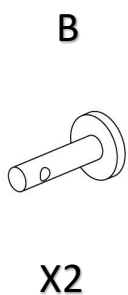

Assemble Instructions:

Assembler les Instructions:

Instrucciones de montaje:

1

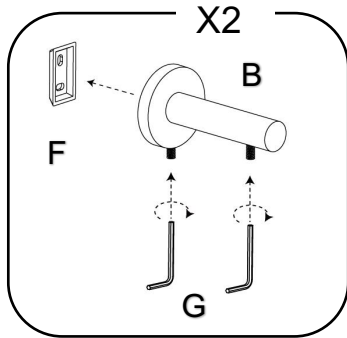

For non-stud mounting:
Montage sur cloison sèche

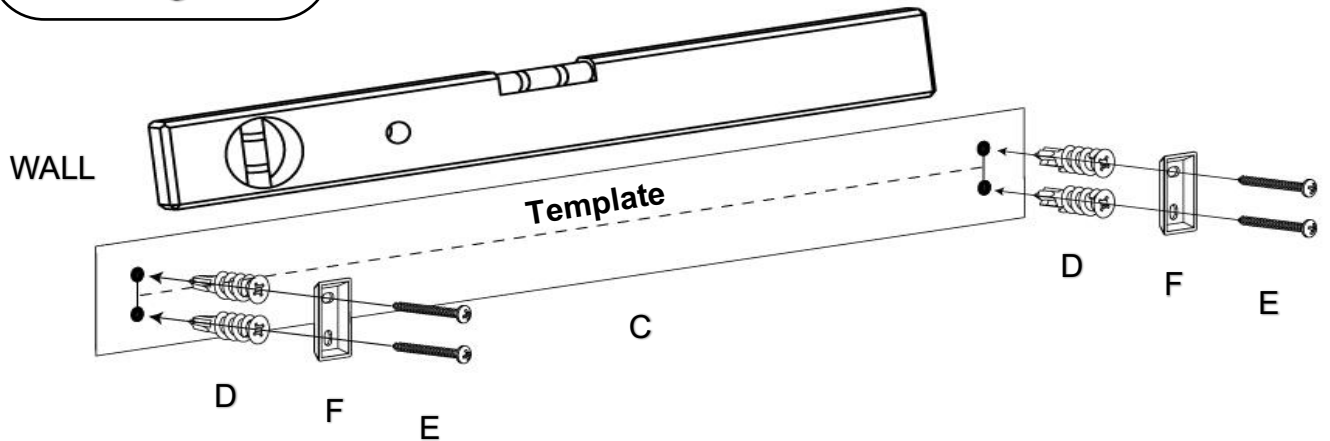
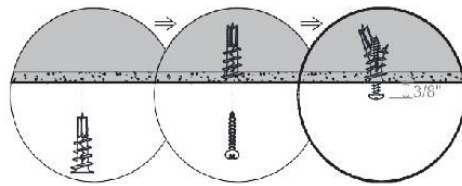

For stud mounting: Montage sur montant : Para el montaje en vigas:

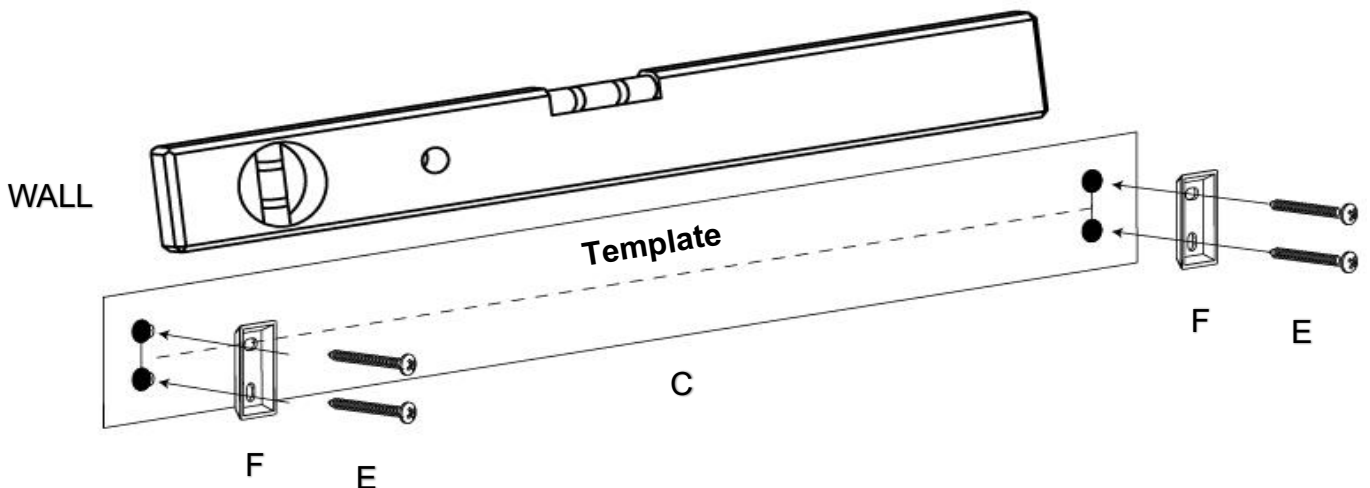
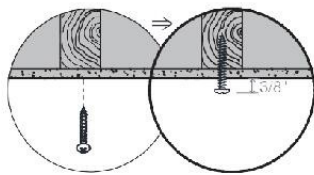

2

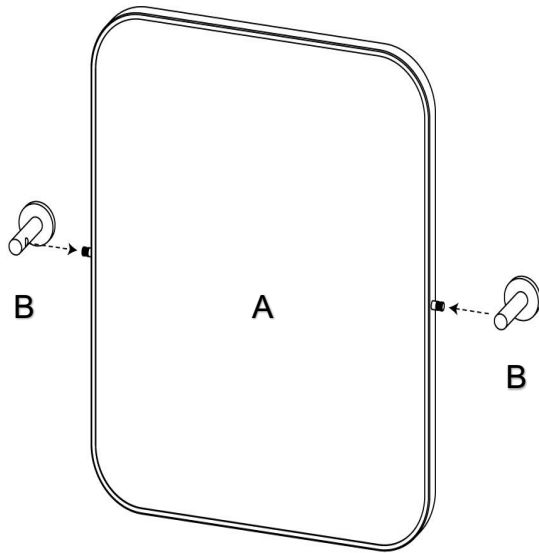

3

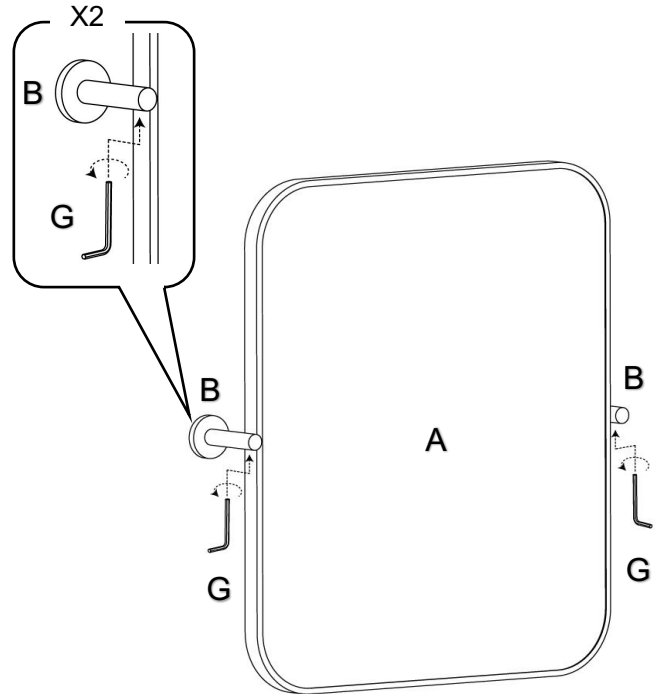

4

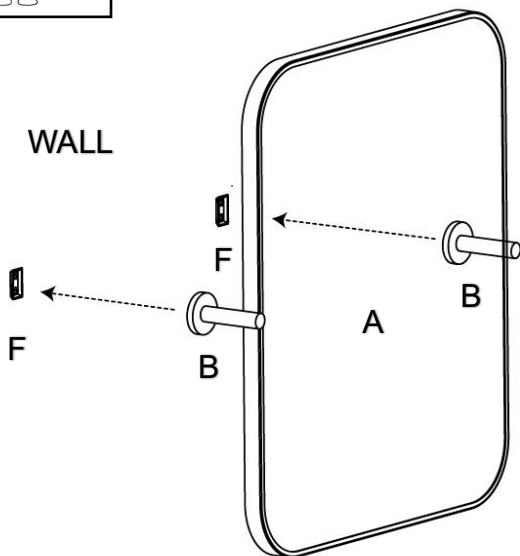
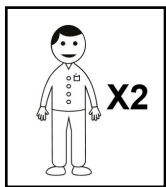

5

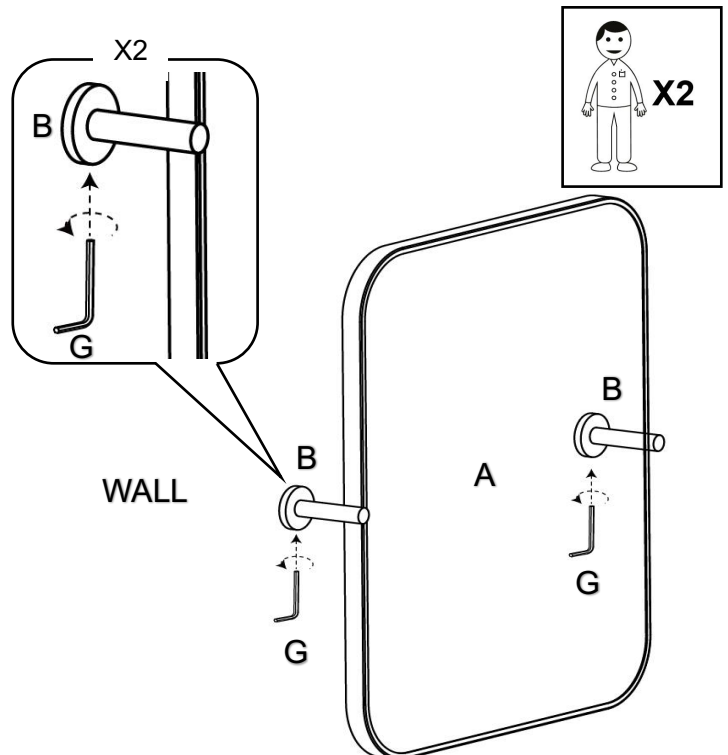

TEMPLATE DESIGN NOTES

