

**BRASS MONKEY SIDE TABLE
TABLETTE LATÉRALE EN LAITON
MESA AUXILIAR DE LATÓN DE LATÓN**

SKU NO 9322988

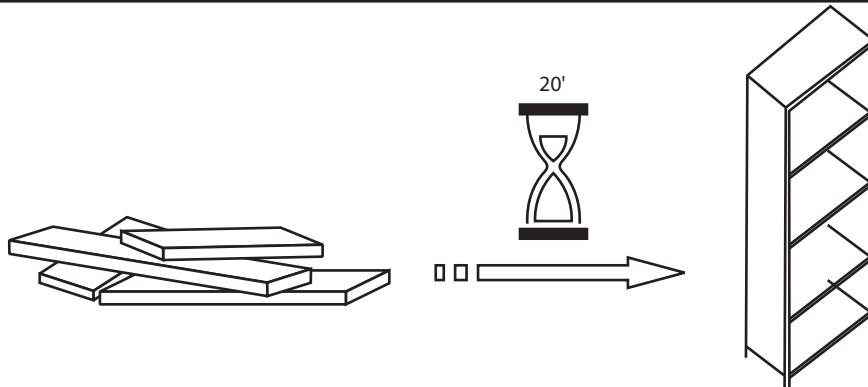

ENGLISH

Do not dispose of any packaging or contents of the shipping carton until assembly is completed to avoid accidentally discarding small parts or hardware.

FRANÇAIS

Ne jetez rien des produits d'emballage et du contenu de la boîte jusqu'à ce que l'assemblage soit terminé, afin d'éviter de jeter par mégarde de petites pièces ou des morceaux.

ESPAÑOL

Para evitar desechar accidentalmente las partes pequeñas o las piezas de ferretería, no tirar el embalaje o contenido de la caja hasta que el ensamblaje esté completo.

Care Instructions:

Please handle glass with care! Damage to the edges or a scratched surface, in extraordinary cases, could cause the glass to spontaneously crack into small pieces. Avoid impacts to the edges where the glass is most vulnerable.

DO NOT OVER TIGHTEN BOLTS TO ATTACH GLASS TOP.

Dust often using a clean, soft, dry and lint-free cloth.

When blot spills, wipe with a clean, damp cloth immediately.

We do not recommend the use of chemical cleansers, abrasives or furniture polish on our lacquered finish.

Hardware may loosen over time. Periodically check to make sure all connections are tight. Re-tighten if necessary.

Instructions d'entretien :

Manipulez le verre avec soin! Les dommages aux bords ou à une surface rayée, dans des cas extraordinaires, pourraient provoquer la fissuration spontanée de petits morceaux. Évitez les impacts sur les bords où le verre est le plus vulnérable.

NE PAS VERSER LES BOULONS.

Épousseter régulièrement avec un chiffon propre, doux et non pelucheux.

Éponger immédiatement les liquides renversés et essuyer à l'aide d'un chiffon propre et humide.

L'utilisation de produits nettoyants chimiques, d'abrasifs ou d'encaustiques sur nos finitions laquées n'est pas recommandée.

Le matériel de fixation peut se desserrer avec le temps. Vérifiez régulièrement afin de vous assurer que tous les raccords sont bien serrés. Resserrez-les au besoin.

Instrucciones de cuidado:

Por favor, maneje el vidrio con cuidado! Los daños a los bordes o una superficie rayada, en casos extraordinarios, podrían hacer que el vidrio se rompa espontáneamente en trozos pequeños. Evite los impactos en los bordes donde el vidrio es más vulnerable.

NO APRIETE LOS PERNOS

Limpiar el polvo con un trapo limpio, suave, seco y libre de pelusas.

Secar los derrames de inmediato y limpiar con un trapo limpio y húmedo.

Recomendamos no usar limpiadores químicos, abrasivos o lustramuebles sobre el acabado barnizado.

Las piezas de ferretería pueden aflojarse con el tiempo. Controlar periódicamente que estén bien ajustadas. Si es necesario, volver a ajustarlas.

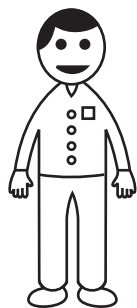

X2

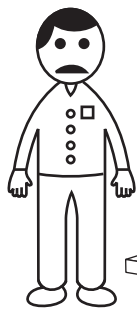
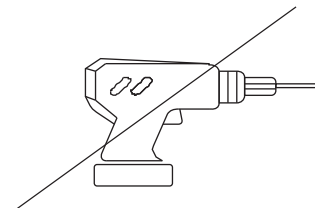
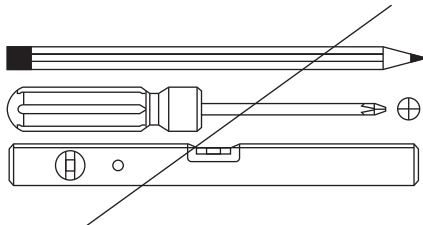

?

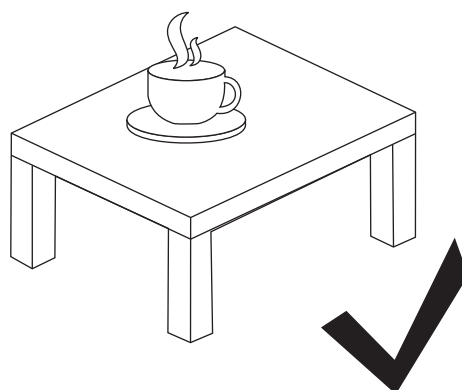
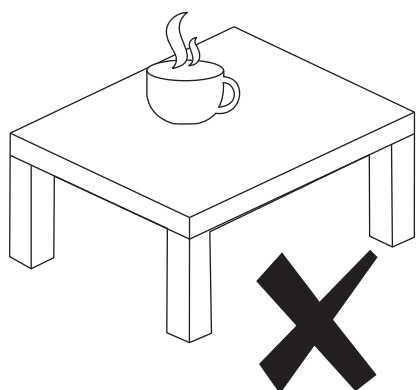
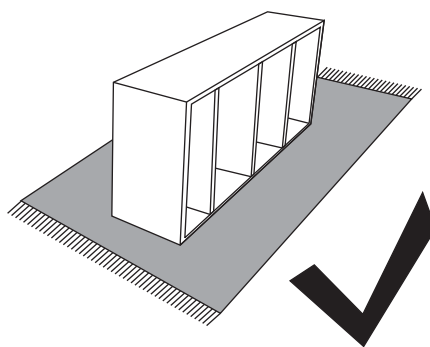
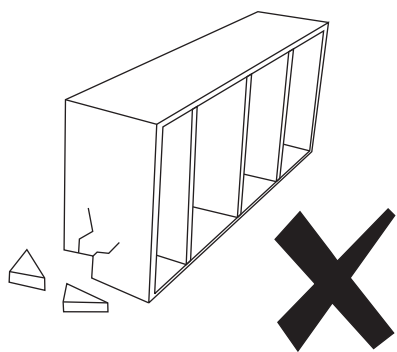
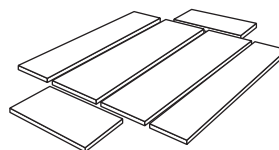
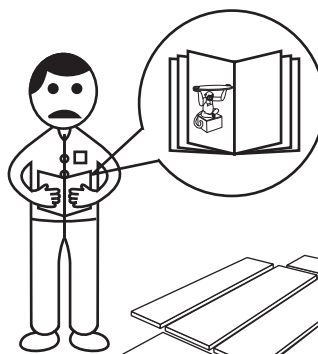
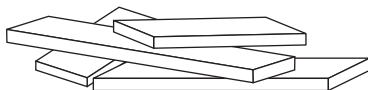
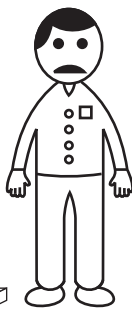

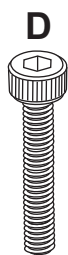
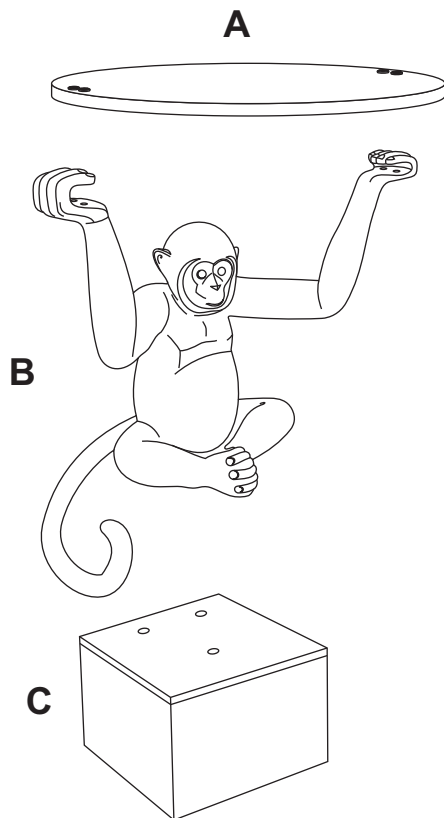

D
M8 x 35mm
3x

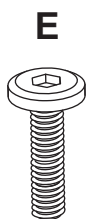

E
M6 x 25mm
4x

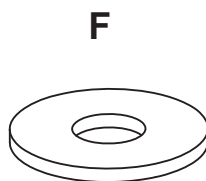

F
Ø25mm X Ø8mm
3x



G
Ø15mm
3x

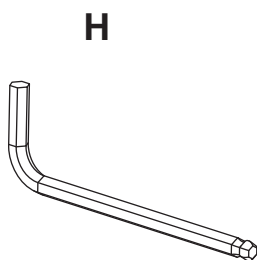

H
Ø4mm X 110mm
1x

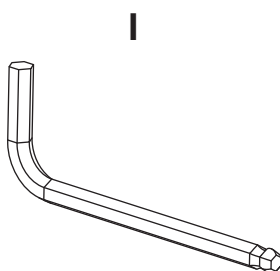

I
Ø6mm X 98mm
1x

1

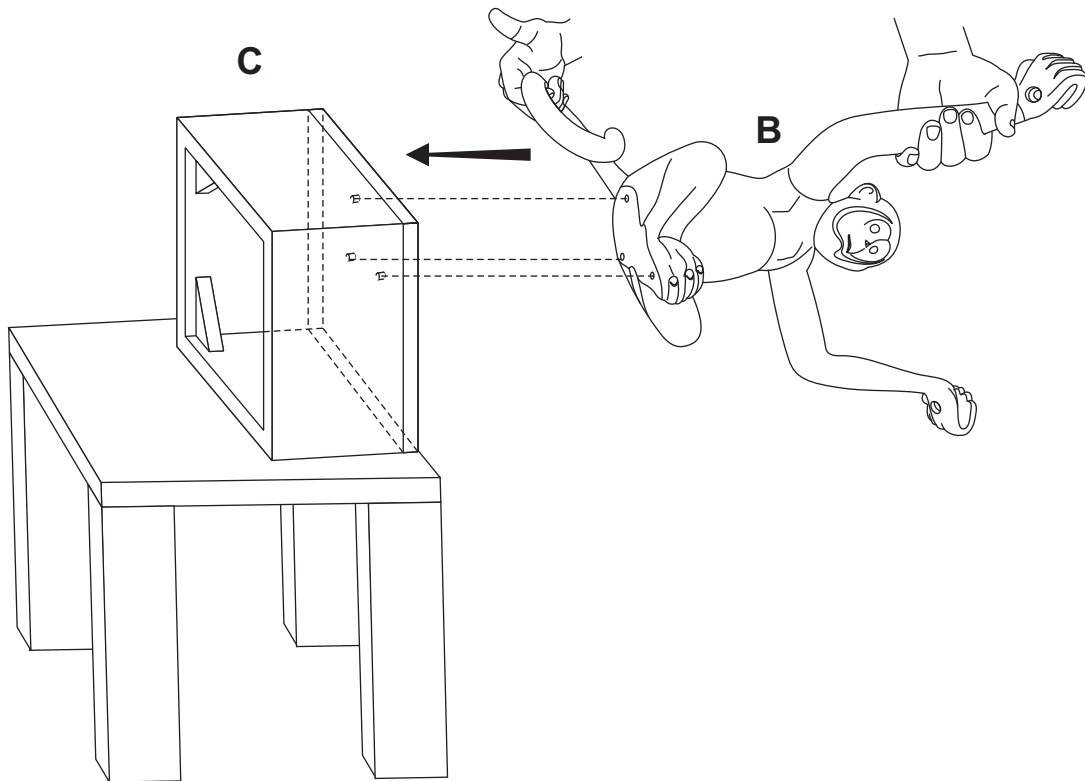

2

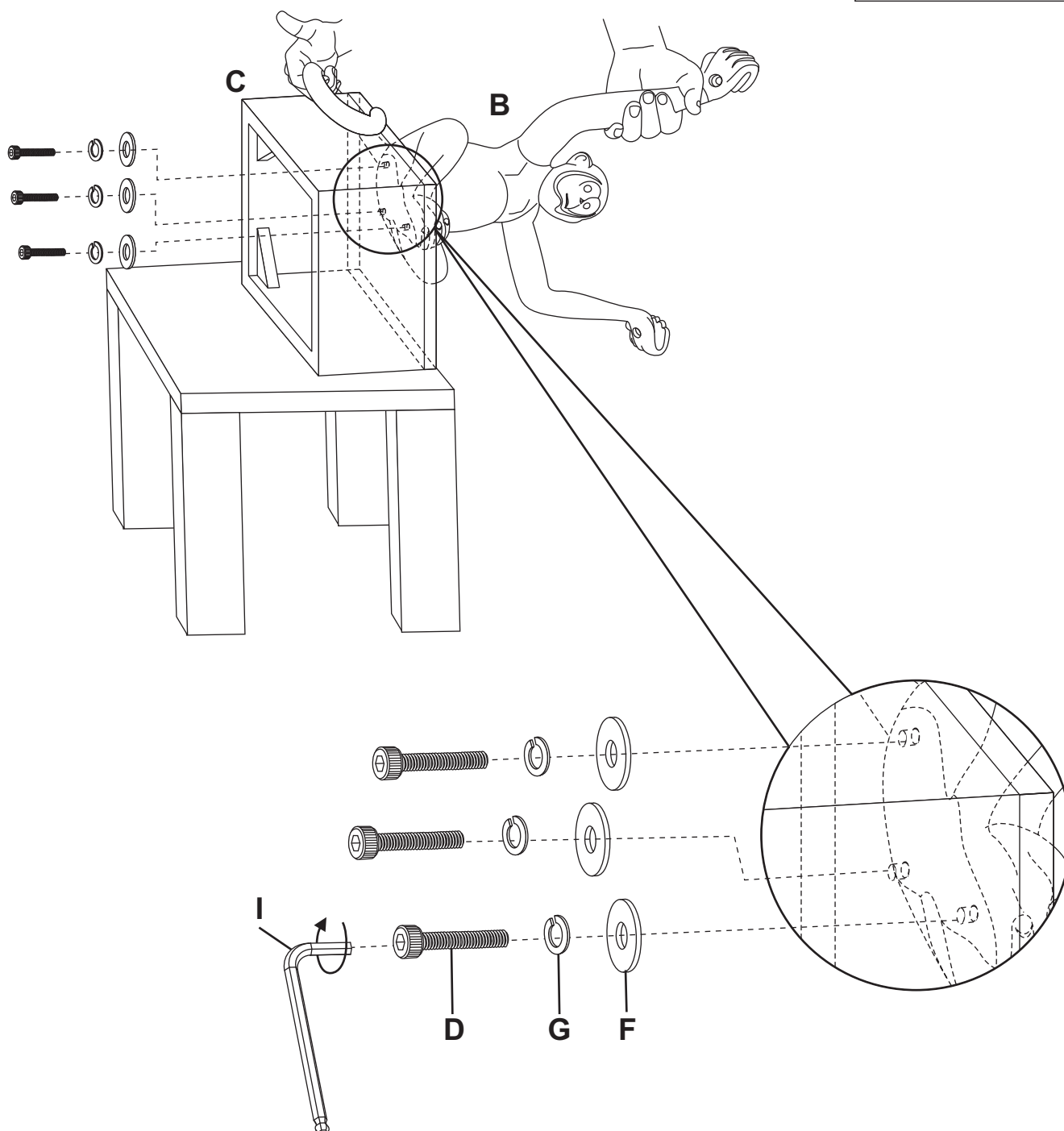
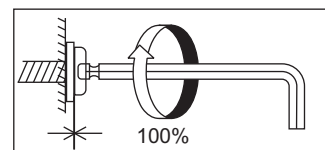

3

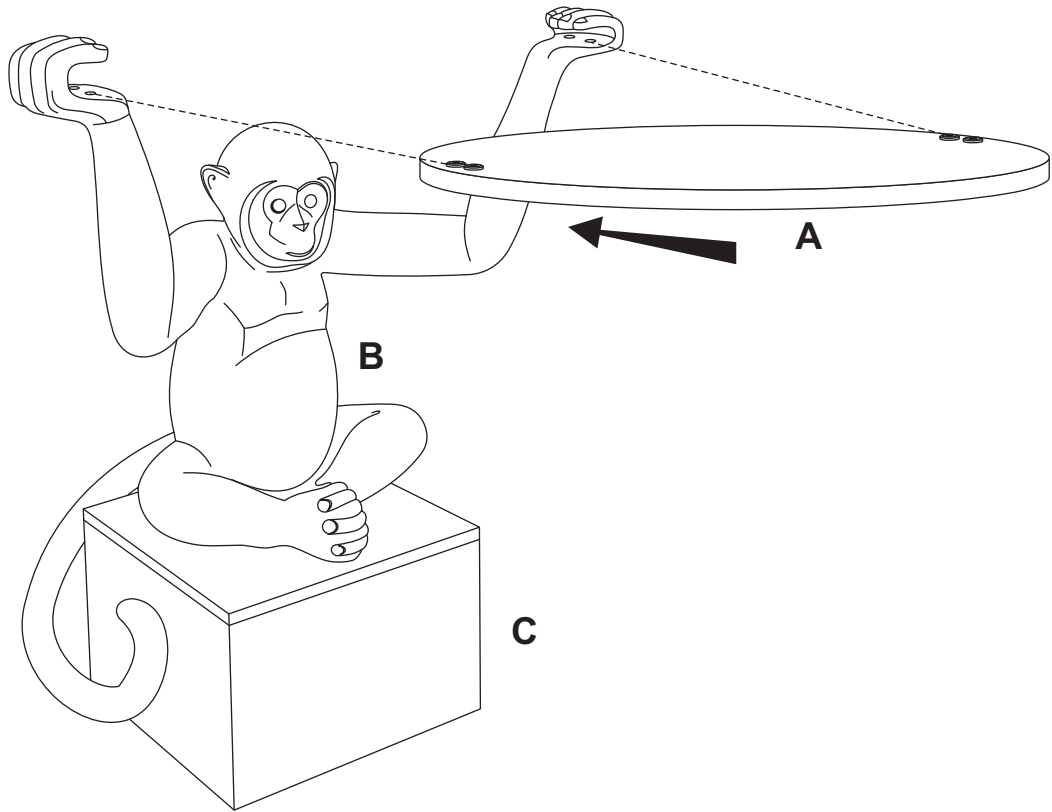

4

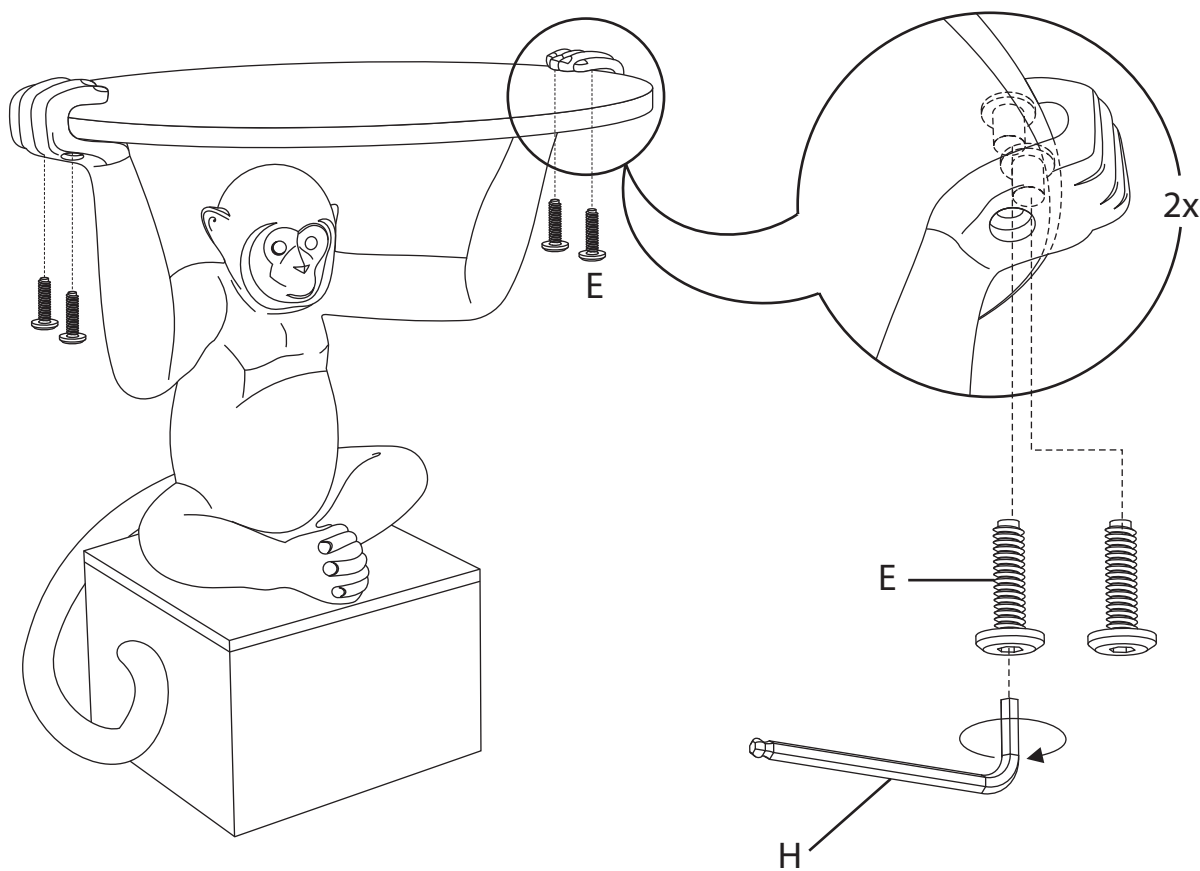
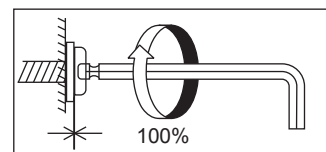

DO NOT OVER TIGHTEN BOLTS!
NE PAS VERSER LES BOULONS!
NO APRIETE LOS PERNOS!

5

