



- ! Do not throw away packaging materials until assembly is complete.
- ! Assemble this item on a soft surface, such as cardboard or carpet, to protect finish.
- ! Proper assembly of this item requires 2 people.
- ! Ne jetez pas le matériel d’emballage avant d’avoir terminé le montage.
- ! Montez cet article sur une surface lisse, telle que du carton ou un tapis, pour en protéger la finition
- ! Deux personnes sont nécessaires pour monter cet article de façon adéquate.
- ! No descarte los materiales de embalaje hasta finalizar el ensamblaje.
- ! Ensamble el producto sobre una superficie suave, como carton o alfombra, para proteger el acabado.
- ! Se requieren 2 personas para ensamblar el producto de forma adecuada.



CARE INSTRUCTIONS/ENTRETIEN/INSTRUCCIONES DE CUIDADO

Hardware may loosen overtime. Periodically check that all connections are tight. Wipe with a soft, dry cloth. To protect finish, avoid the use of chemicals and household cleaners. All hot serving dishes should be placed on a pad. Any liquid spilled onto the furniture should be cleaned up immediately with a damp cloth.

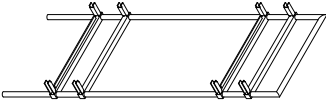
Le matériel peut se desserrer avec le temps. Vérifiez régulièrement que tous les raccords sont bien serrés. Essuyez à l’aide d’un linge doux et sec. Pour protéger la finition, évitez l’utilisation de produits chimiques et de détergents ménagers. Tous les plats de service chauds doivent être déposés sur un dessous de plat. Tout déversement doit être nettoyé immédiatement à l’aide d’un linge humide.

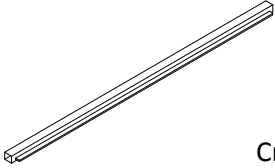
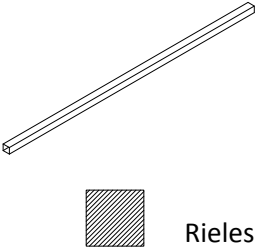
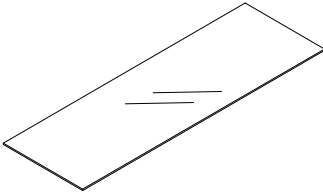
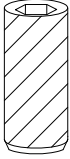
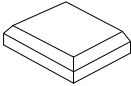
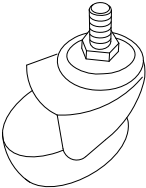
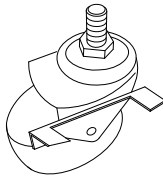
Las partes pueden aflojarse con el tiempo. Chequee de manera constante que todas las conexiones estén ajustadas. Limpie con un trapo suave y seco. Para proteger el acabado, evite el uso de químicos y limpiadores domésticos. Cualquier plato caliente debe ser colocado sobre manteles. Si derrama algún líquido sobre la mesa, debe limpiarlo de inmediato con un paño húmedo.

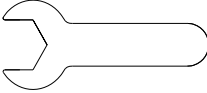
<p>A</p>  <p>Side frame/ Cadre latéral/ Marco lateral</p> <p>2x</p>	<p>B</p>  <p>Washer / Rondelle/ Arandela</p> <p>4x</p>	<p>C</p>  <p>Cross rails / Traverse/ Rieles transversales</p> <p>4x</p>
<p>D</p>  <p>Cross rails / Traverse/ Rieles Transversales</p> <p>4x</p>	<p>E</p>  <p>Mirror/ Miroir/ Espejos</p> <p>2x</p>	<p>F</p>  <p>Connecting screw/ Vis de raccordement / Tornillos conectores M6x12mm</p> <p>32x</p>
<p>G</p>  <p>Rubber pad/ Disque en caoutchouc Almohadillas de goma</p> <p>12x</p>	<p>H</p>  <p>Caster without lock/ Roulette sans frein/ Ruedas sin seguro</p> <p>2x</p>	<p>I</p>  <p>Caster with lock/ Roulette avec frein/ Ruedas con seguro</p> <p>2x</p>

<p>J</p>  <p>1x</p> <p>Wrench/ Clé / Llave</p>	<p>K</p>  <p>1x</p> <p>Hex Key Clé hexagonale/ Llave Hexagonal</p>
---	--

1. Align two side frames (A) with cross rails (C and D) as shown. Insert connecting screw (F). Tighten with supplied hex key (K).
1. Alignez les deux cadres latéraux (A) avec les traverses (C et D), comme illustré. Insérez les vis de raccordement (F). Serrez-les à l'aide de la clé hexagonale (K) fournie.
1. Enfile los dos marcos laterales (A) con los rieles transversales (C y D) como se muestra. Inserte el tornillo conector (F). Apriete con la llave hexagonal suministrada.

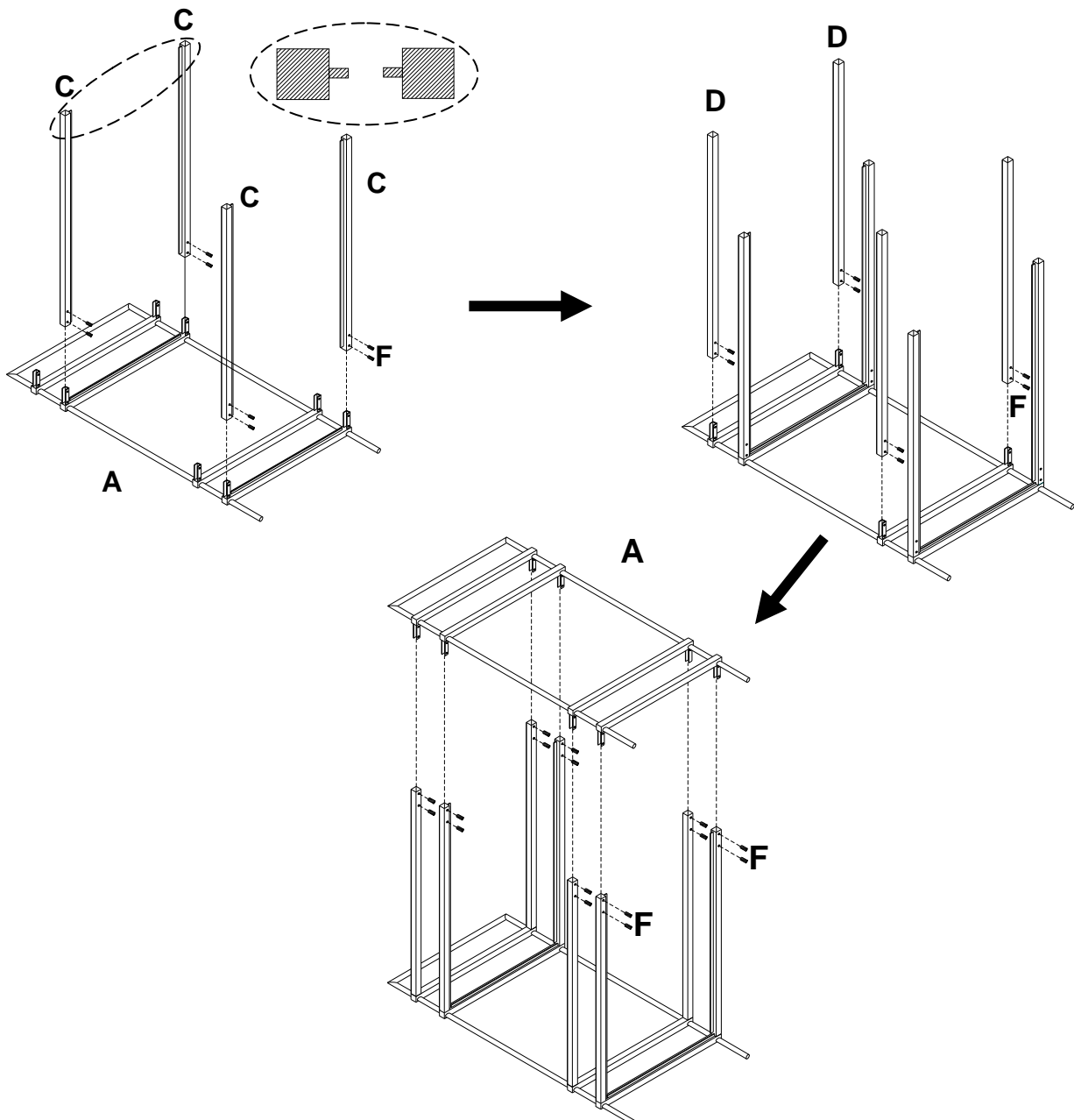

2. Insert casters (H and I) thru washer (B). Tighten with supplied wrench (J). Attached the rubber pad (G) to cross rails (C) as shown, and then gently lay the mirrors (E) to assembled cart. Assembly is complete.
2. Insérez les roulettes (H et I) dans une rondelle (B). Fixez-les à l'aide de la clé hexagonale (J) fournie. Fixez le disque en caoutchouc (G) sur les traverses (C) comme illustré et déposez ensuite les miroirs (E) sur le bar assemblé
2. Inserte las ruedas (H e I) a traves de la arandela (B). apriete con la llave (J). Coloque las almohadillas de goma (G) en los rieles (C) como se muestra, luego coloque los espejos (E) en el carro ensamblado. Ha terminado el ensamblaje.

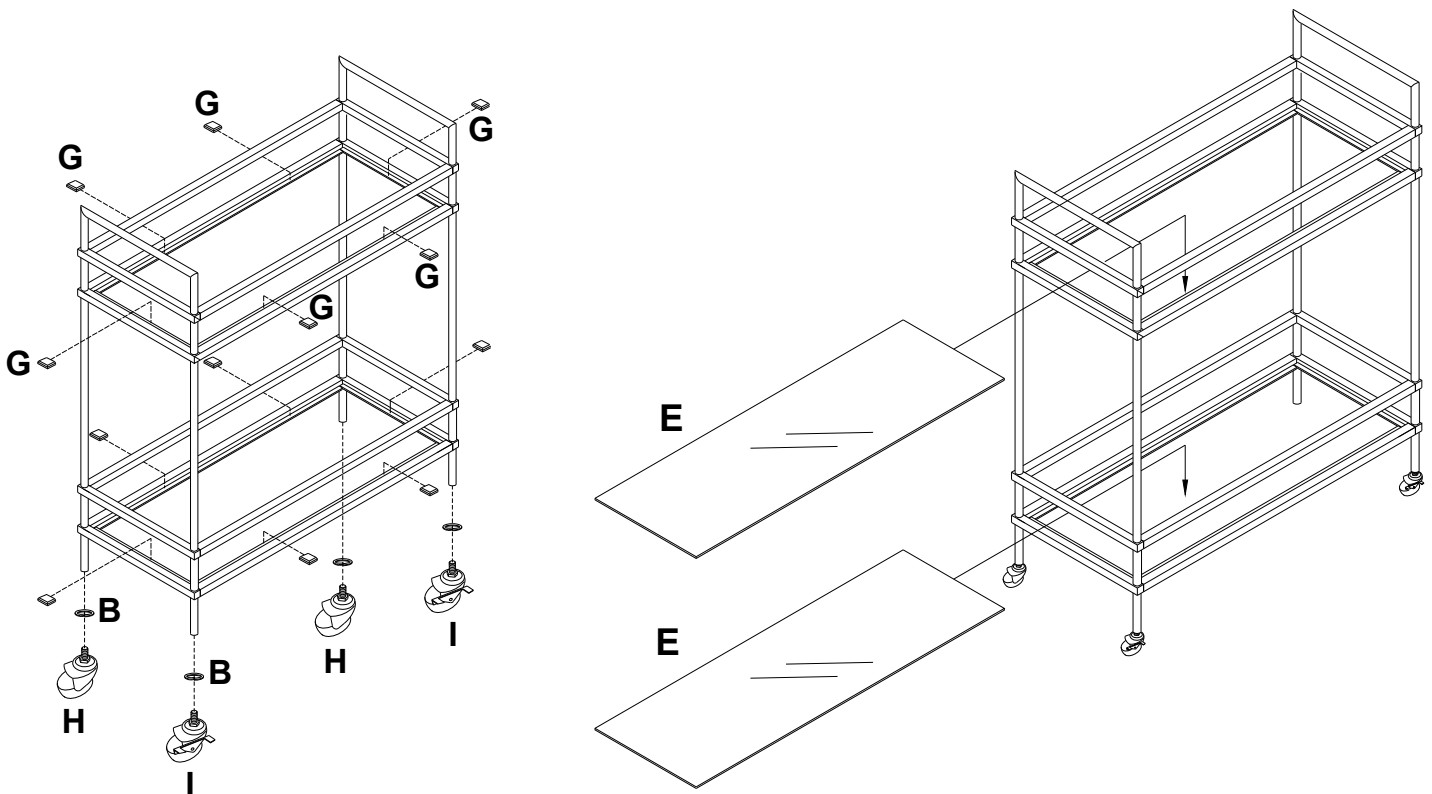

Terrace Collection

Assembly Trouble Shooting Guide

We selected **Set Screws** for the assembly of our Terrace Collection as they provide a low profile, more seamless look.

For best results, its important that you take a moment to familiarize yourself with this type of hardware and its operation.



The **sets screws** provided have two ends:

- A.** Has a circular dimple
*This is end that is inserted into the frame
- B.** Has a allen (hex) drive socket

The **allen wrench** provided also has two ends:

- 1.** Is a ball end
*This end is used **first** to insert screws
- 2.** Is a straight end
*This end is used **second** to fully tighten screws

Follow these additional steps when assembling:



1. Assemble your Terrace Collection furniture as shown in the assembly instructions provided - making sure the allen end of the set screw faces out.



2. When first inserting the sets screws - use the **ball end** of the allen wrench. Insert the screws until you feel resistance.



3. After inserting all screws - use the **straight end** of allen wrench to go back and fully tighten all screws.

*No more than an additional 1/2 turn should be necessary.

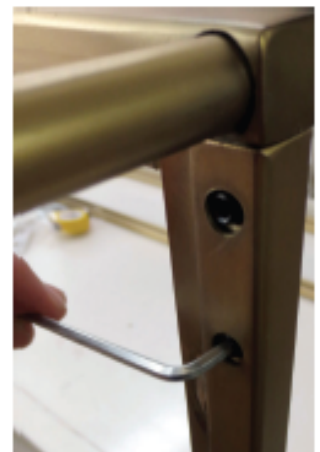

4. Check for movement in the connections. If any movement still exists carefully tighten the screws an additional 1/4 turn.

If all connections feel tight, finish assembling and enjoy!

west elm