

west elm

morgan wedge unit

assembly instructions

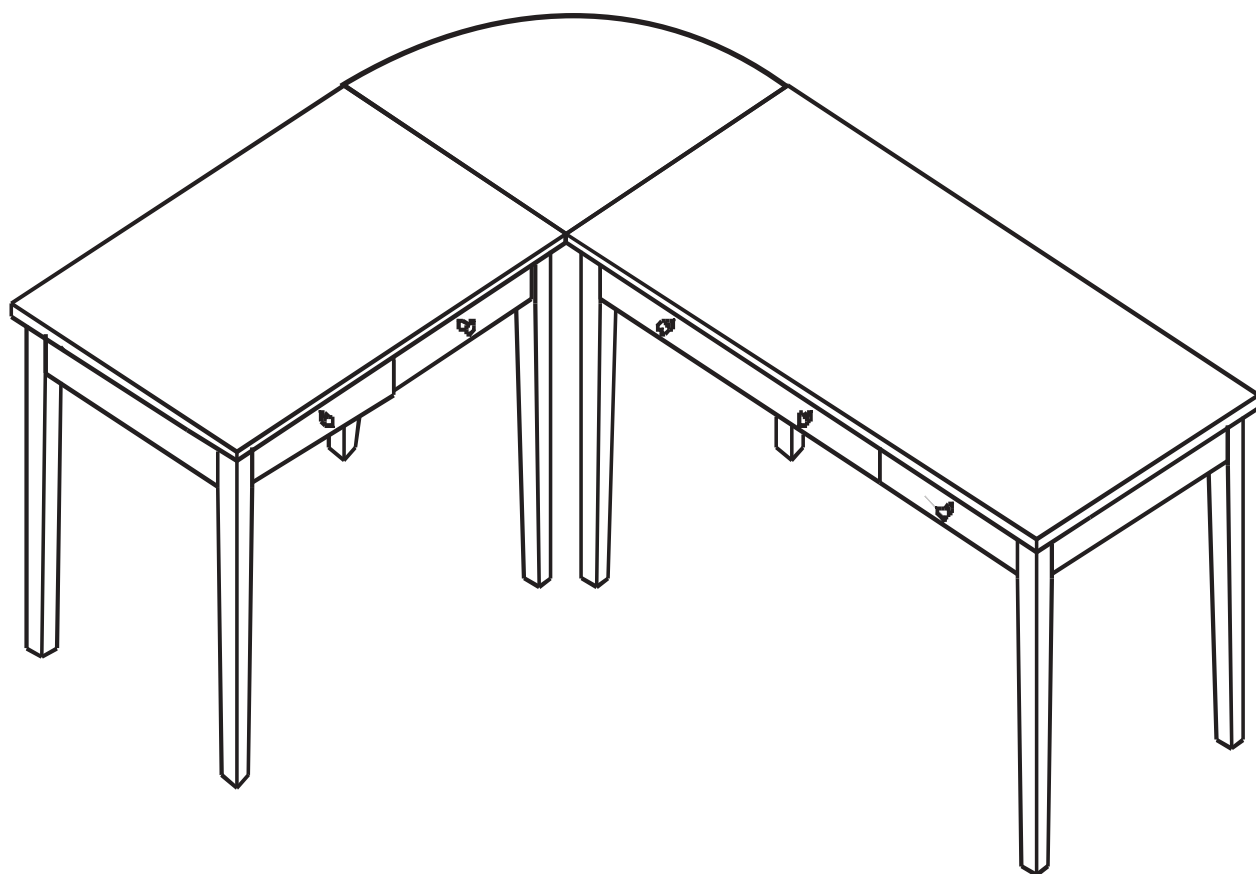

! Tools required:

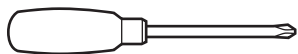

! Do not throw away packaging materials until assembly is complete.

! Assemble this item on a soft surface, such as cardboard or carpet, to protect finish.

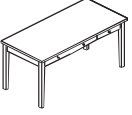

Large desk x 1  
(sold separate SKU)

A

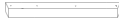

Wooden Brace x 1

D

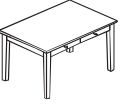

Small desk x 1  
(sold separate SKU)

B

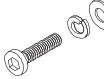

Allen bolt with Flat &  
Lock washer

x 16 E



Corner connector x 1

C



Allen key wrench (included) x 1

F

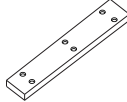

wooden bars x 2

G

1

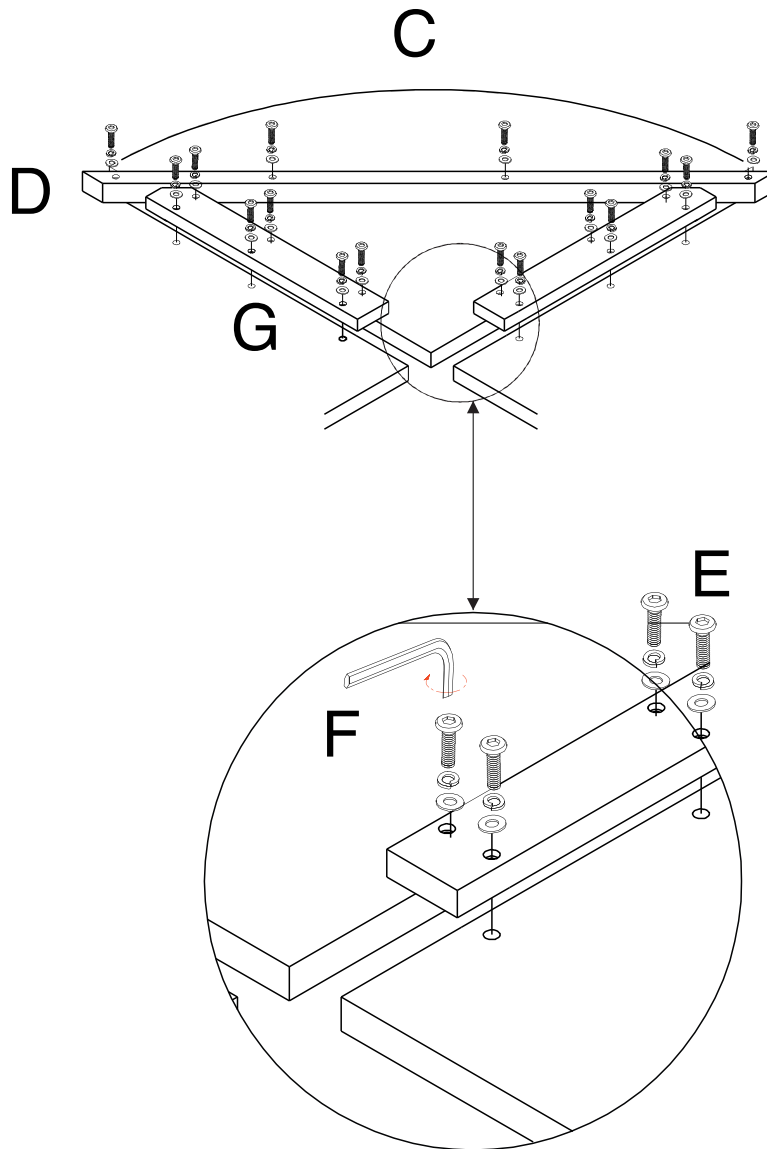

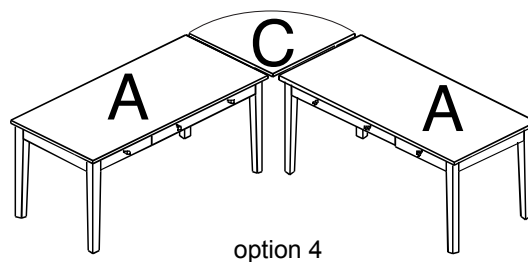
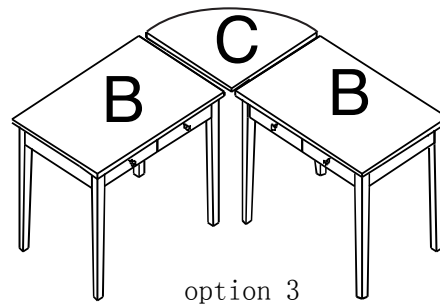
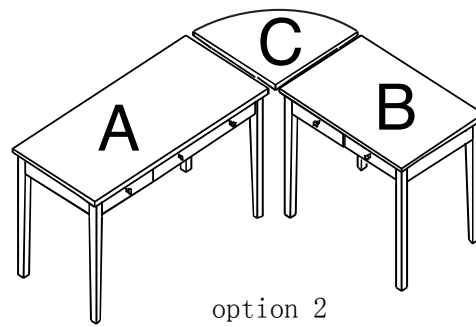
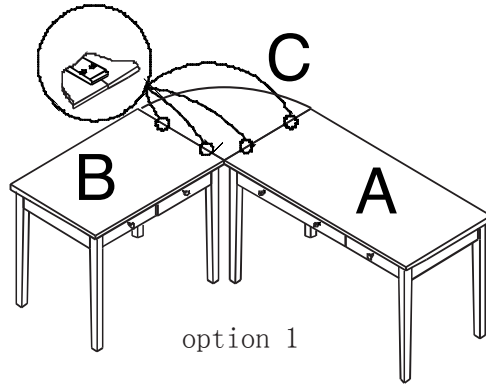

2

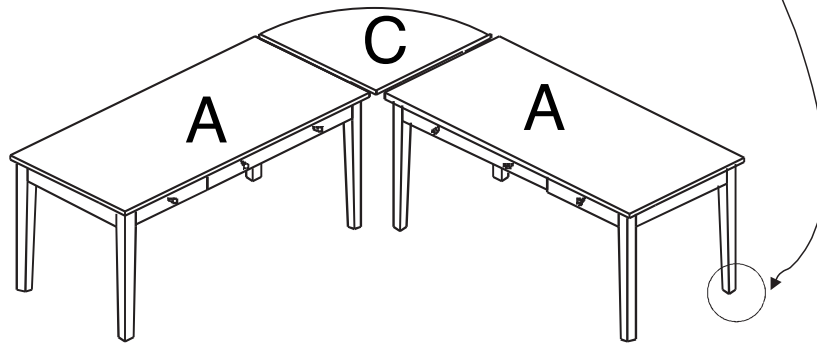
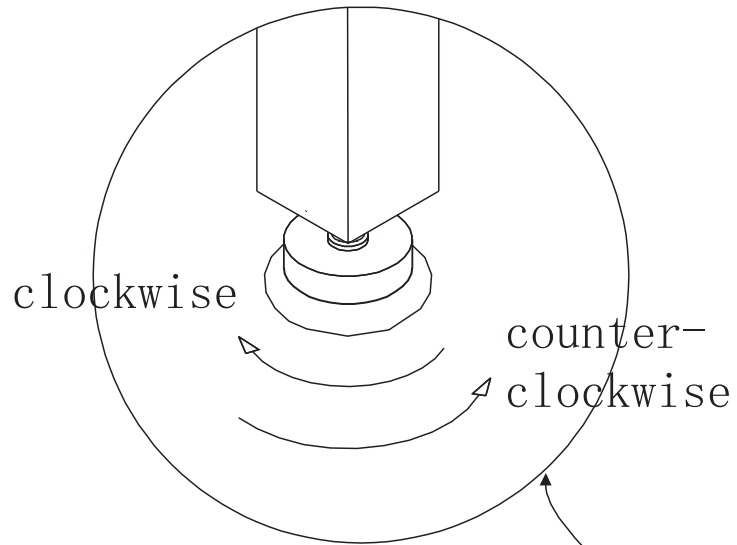

CARE INSTRUCTION

Hardware may loosen over time. Periodically check that all connections are tight.

Wipe with a soft, dry cloth. To protect finish, avoid the use of chemicals and household cleaners.