

CAUTION:

- **BEFORE INSTALLING FIXTURE, MAKE SURE THE POWER TO THE CIRCUIT IS TURNED OFF AT THE MAIN FUSE BOX / CIRCUIT BREAKER UTILITY BOX.**

Important Safety Instructions:

- These instructions are provided for your safety. It is very important that they are read carefully and completely before beginning the assembly and installation of this lighting fixture.
- We strongly recommend that a professional electrician install all direct wire fixtures.
- THIS PRODUCT MUST BE INSTALLED IN ACCORDANCE WITH THE APPLICABLE INSTALLATION CODES BY TWO PERSONS FAMILIAR WITH THE CONSTRUCTION AND OPERATION OF THE PRODUCT AND THE HAZARDS INVOLVED.
- The lighting fixture is meant for indoor use. It must be connected only to 3-wire, single-phase electrical supply systems (provided with Ground wire or equivalent protection system).
- For your safety, it is strongly recommended that two people install the lighting fixture.
- This fixture has been rated for up to six (6) **60-Watt maximum TYPE G standard incandescent light bulbs** (not included) or six (6) **7-Watt maximum Self- Ballasted LED bulbs** (not included). To avoid the risk of fire, do not exceed the recommended lamp wattage.
- It is recommended to use white bulbs. If clear bulbs are used, then there will be streaks/shadows in the glass shade.
- The lighting fixture is meant for indoor use, DRY LOCATIONS ONLY.
- **Save these instructions.**

WARNING:

- **To reduce the risk of fire, electrical shock or personal injury, always turn off light fixture and allow it to cool prior to replacing light bulb.**
- **Do not touch bulb when fixture is turned on. Do not look directly at lit bulb.**
- **Keep flammable materials away from lit bulb.**

Pre-assembly:

- Remove all parts and hardware from box along with any plastic protective packaging.
- Do not discard any contents until after assembly is complete to avoid accidentally discarding small parts or hardware.
- For your safety, it is strongly recommended that two people install the lighting fixture.

TOOLS REQUIRED (not included):

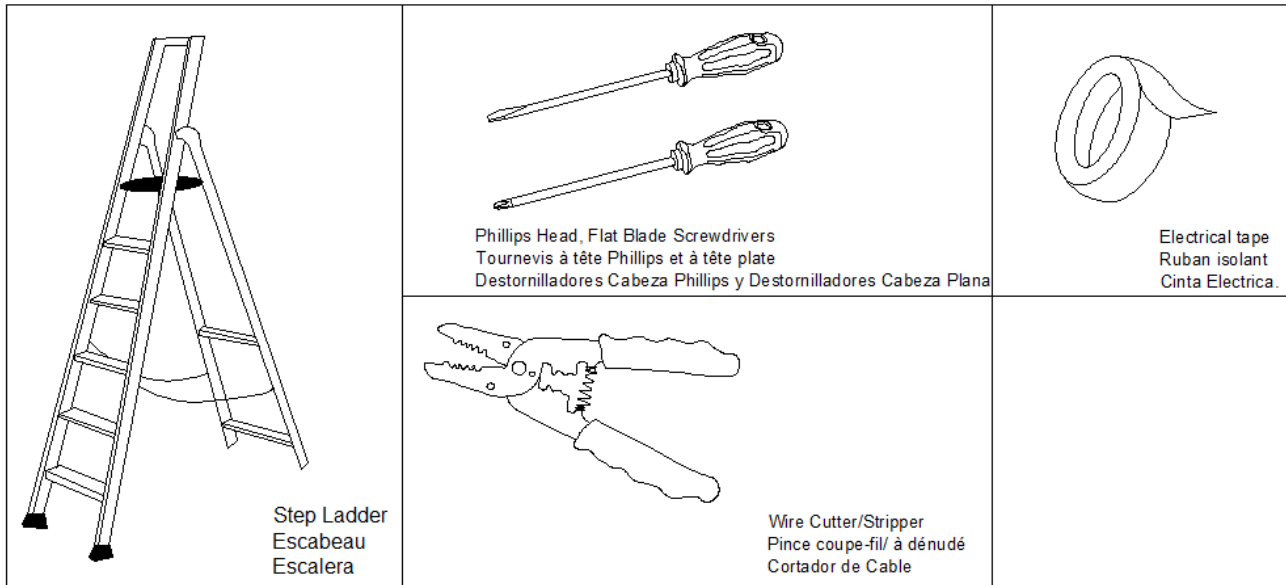





Parts Included:

- (A) Mounting Plate (1)
- (B) Canopy Screws (3)
- (C) Canopy (1)
- (D) Ball Joint (1)
- (E) 12-Inch Lamp Tubes (3)
- (F) 6-Inch Lamp Tube (1)
- (G) Fixture Tube (1)
- (H) Shade Outer Thread-Rings (6)
- (Q) Sockets (6)
- (K) Shade Inner Thread-Rings (6)
- (J) Glass Shades (6)
- (S) Joint (6)
- (T) Lamp Stems (6)
- (V) plastic ring (6)
- (M) Steel Wire (1)

Hardware Enclosed:

- (L) Mounting Screws (2)
- (N) Plastic Wire Nut Connectors (3)
- (P) Green Ground Screw (1)
- (O) Allen key (1)
- (U) Fix screws (15) (3 for spares)

 L x2	 N x3	 O x1
 P x1	 U x15	

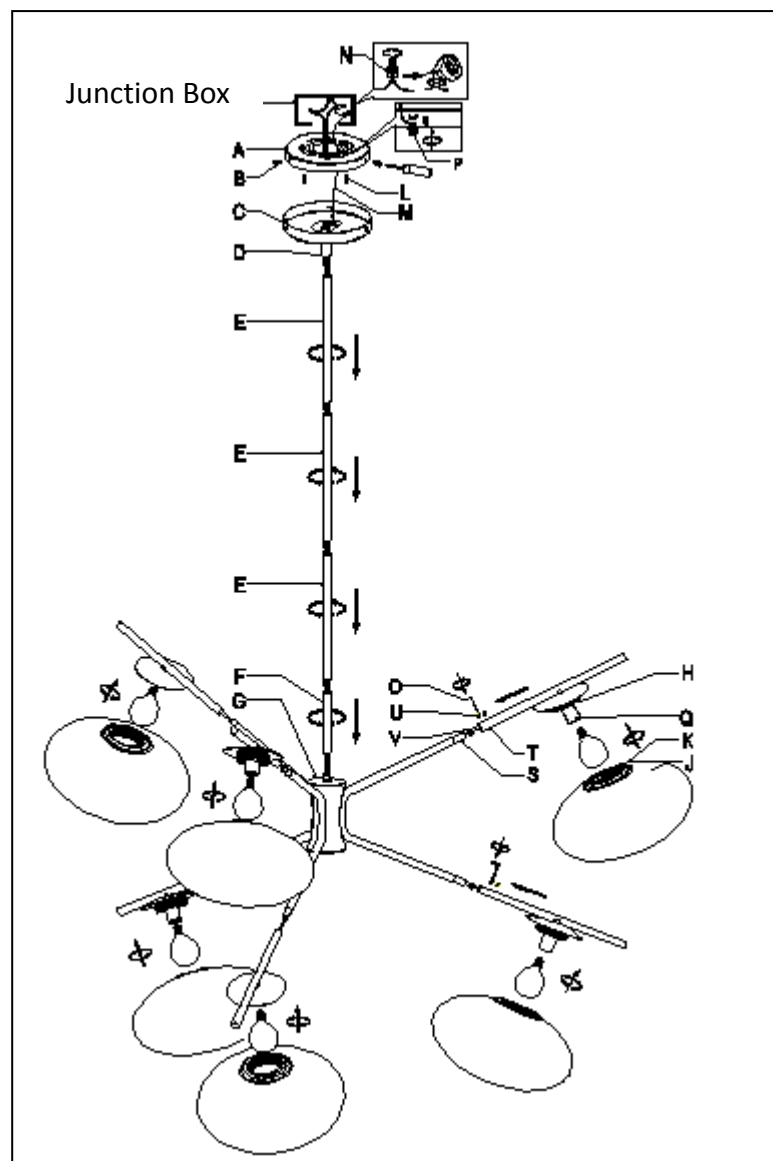

To Adjust The Suspension Length Of The Fixture:

Note: The adjustment or shortening of the lighting fixture's suspension length is only needed if the factory set length is not appropriate for your installation. We recommend that you adjust the proper desired length before cutting the electrical cord. Determine the lighting fixture suspension length from the ceiling for the product installation, allowing the extra cord length for the outlet junction box wire connections as noted below.

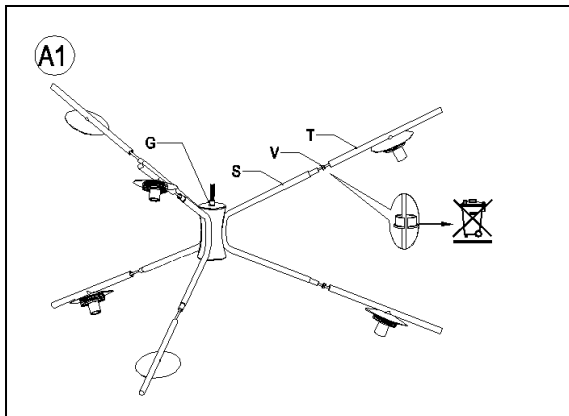

1. Remove the plastic ring (V) and put it in the garbage can..

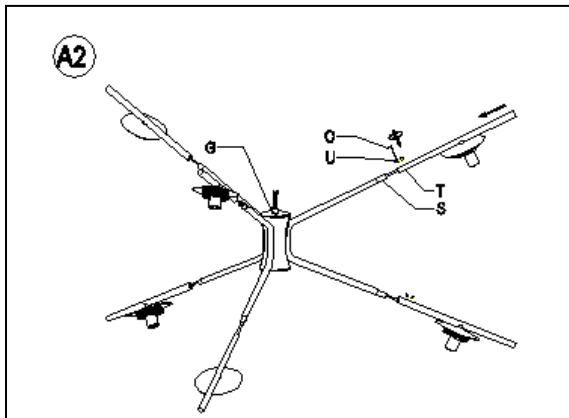

2. On the Joint (S) of the Lamp Stems (T), the Fix screws(U) is locked on the Joint (S) platform with the Allen key(O) until the fastening.

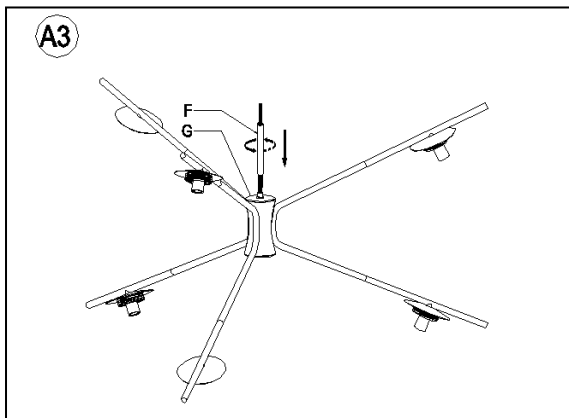

3. Insert the fixture 2 wire **and bare ground** power cords through the 6 in. Tube (F), and attach bottom end of the 6 Inch Lamp Tube (F) onto the threaded tube of Fixture Tube (G) and turning in a clockwise direction until tight.

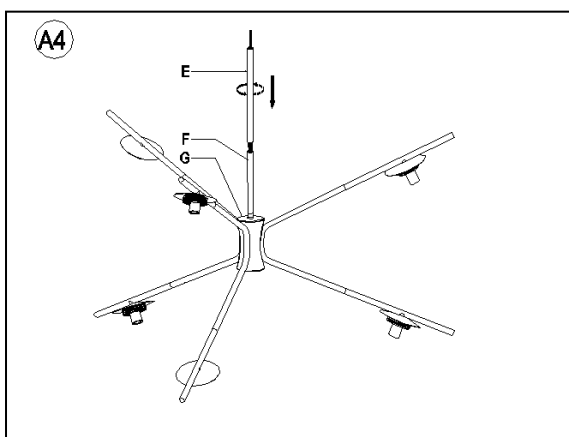

4. If you would like to use only one 12 in. Tube (E), then thread the 2 wire **and bare ground** power cords through the 12 Inch Lamp Tube (E), making sure the tube nipple joint end is downward as shown in diagram A2. Attach the bottom end of 12 Inch Lamp Tube (E) onto the top end of 6 in. Tube (F) and rotate clockwise until tight.

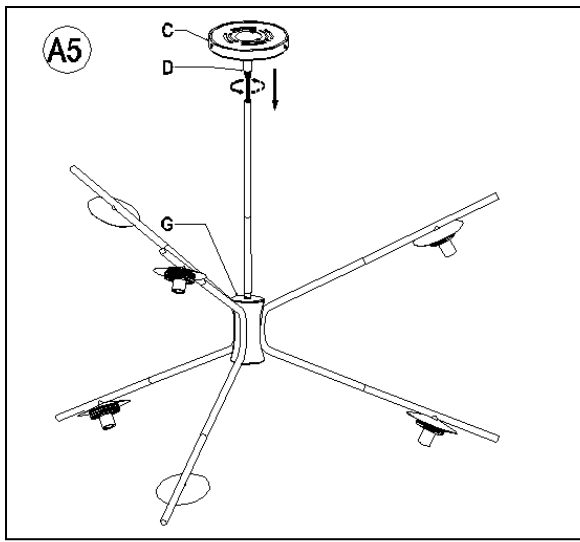

5. Use the additional 12 Inch Lamp Tube (E) as needed to adjust the fixture's suspension length by following the similar procedure as outlined in step 2. Once the fixture's suspension length is determined, thread the 2 wire and bare ground power cords through Ball Joint (D) and Canopy (C). Attached the Ball Joint (D) onto the 12 Inch Lamp Tube (E) and rotate clockwise until tight.

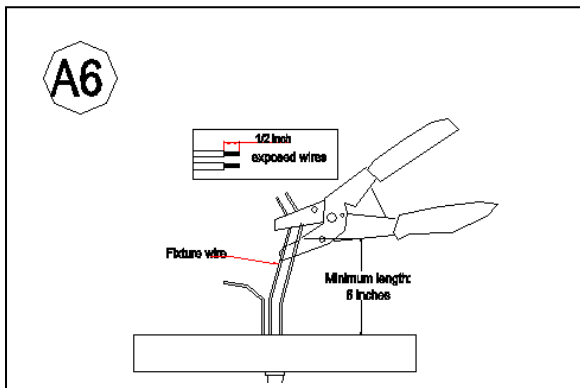

6. If needed, cut off the extra power cord length on the 2 wires and bare ground wire so that they are at least 6 inches (152.4 mm) long within the outlet junction box (J-box).

Assembly & Installation Instructions:

- **SHUT OFF THE MAIN ELECTRICAL SUPPLY FROM THE MAIN FUSE BOX/CIRCUIT BREAKER.**
- Carefully unpack all fixture parts and hardware and lay them on a clear workspace.
- If the parts are not already preassembled or if suspension length adjustments were not made, please use the instruction section above "To Adjust the Suspension Length of the Fixture" for the proper assembly of the Tubes (E&F) to the desired suspension length.

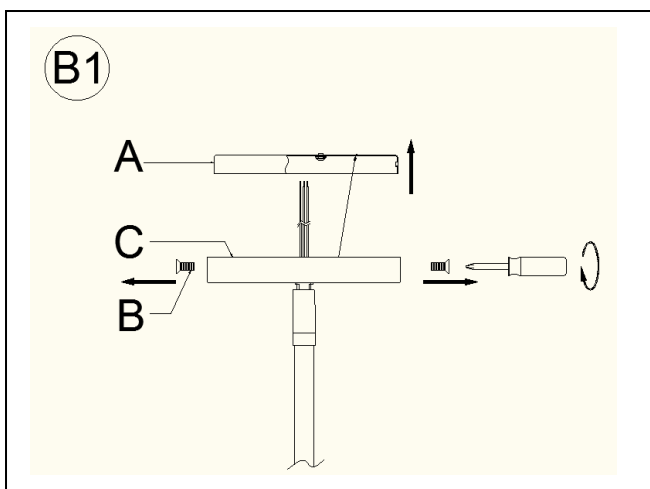

1. Separate the Mounting Plate (A) from the Canopy (C) by removing the 3 Canopy Screws (B). Do not discard the Canopy Screws (B) as these will be used later.

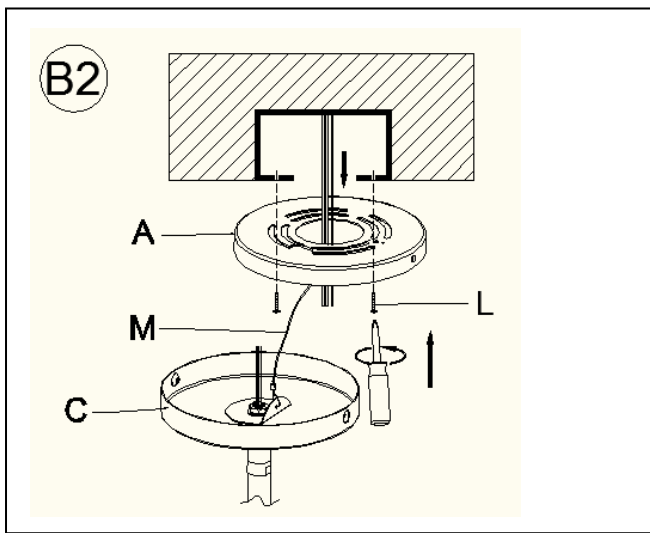

2. Insert the J-box wires through the center opening of the Mounting Plate (A). Attach the Mounting Plate (A) to the junction box using the two J-Box Mounting Screws (L). Tighten each screw clockwise until the Mounting Plate (A) is firmly secured to the J-Box. Then the steel wire (M) can hang up the fixture securely.

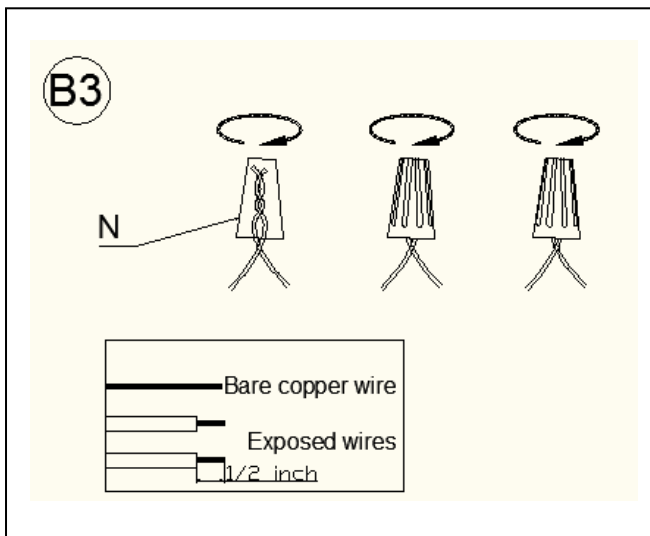

3. Please read the section "To Make the Wire connections" below.

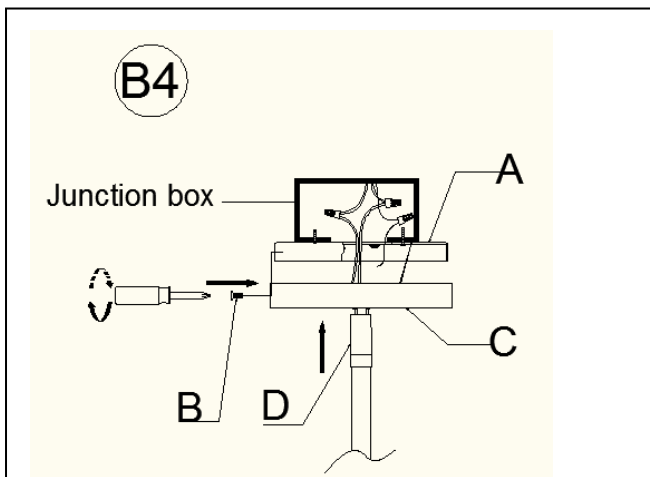

4. With the help of another people to hold the weight of the light fixture, Raise the Canopy (C) up over the Mounting Plate (A). Align the holes on the Mounting Plate (A) with the holes on the side of the Canopy (C). Insert the 3 Canopy Screws (B) and tighten with a screwdriver.

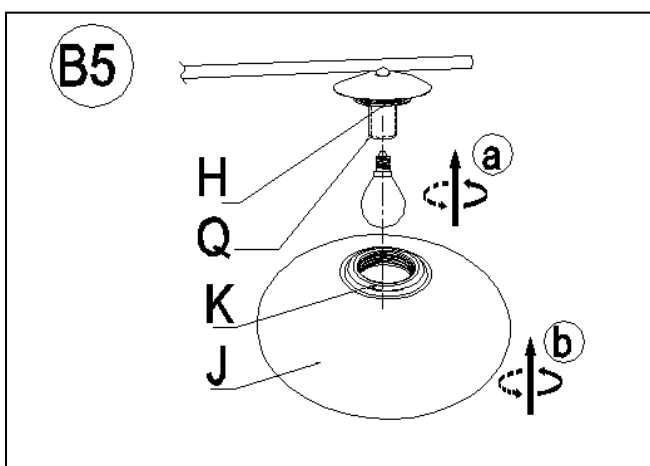

- 5.1 Insert the specified light bulbs into the Sockets (Q). DO NOT EXCEED THE SPECIFIED WATTAGE.
- 5.2 Then hold glass shade (J) and attached Shade Inner Thread-Rings (K) onto the Shade Outer Thread-Rings (H), then turning in a clockwise direction until tight.
- 5.3 Follow step 5.2 to secure all the glass shades(J).

To Make the Wire Connections:

1. Gently pull the wiring from the ceiling junction box and allow wires to hang. The HOT or LIVE wire is usually black. The NEUTRAL wire is usually white. Check to see if there is a ground wire that is usually green or green with a yellow stripe or exposed copper metal wire. If needed, use a pair of wire strippers to remove about 1/2 inch of insulation from each wire.
2. Carefully inspect the fixture wires. The NEUTRAL FIXTURE WIRE is White. The HOT FIXTURE WIRE is Black. The BARE COPPER WIRE is the GROUND WIRE. If you have any doubt and cannot identify the power-supply wires with confidence, then we recommend that you ask an electrician and that you not continue with the installation.
3. With the help of another person to hold the weight of the fixture, attach the fixture wires to the junction box wires as shown in the illustrations.

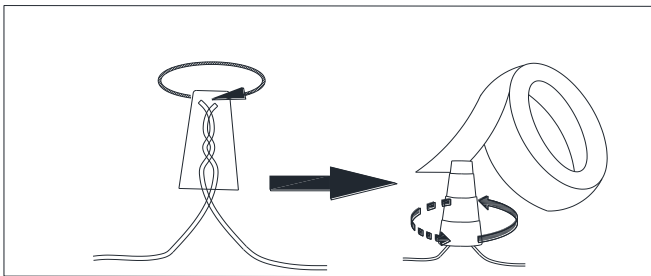

Connect the GROUND FIXTURE WIRE to the GROUND J-BOX WIRE using the Plastic Wire Nut Connector (N) and wrap the connection with electrical tape. Be sure that no wire strands are exposed.

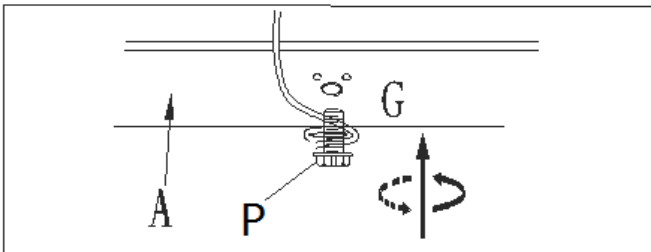

If the junction box DOES NOT have a GROUND WIRE, wrap the fixture's bare ground wire around the Green Ground Screw (P) and insert the screw into the Mounting Plate (A), marked as "G", and tighten screw to secure the wire.

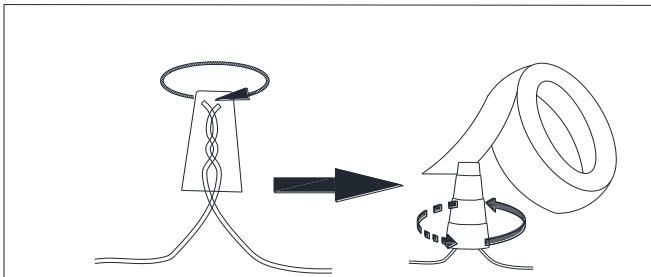

Connect the NEUTRAL FIXTURE WIRE to the NEUTRAL J-BOX WIRE first and then connect the HOT FIXTURE WIRE to the HOT J-BOX WIRE using the Plastic Wire Nut Connectors (N). Wrap these connections with electrical tape. Be sure that no wire strands are exposed.

NOTE:

IT IS IMPERATIVE THAT THE JUNCTION BOX IN YOUR HOME BE PROPERLY GROUNDED!

DO NOT REVERSE THE HOT AND NEUTRAL CONNECTIONS OR SAFETY WILL BE COMPROMISED.

4. Check the wiring connections and if all looks good, gently tuck the wire connections neatly into the junction box.

Care instructions:

- Wipe clean with a soft, dry cloth or static duster.
- Always avoid the use of harsh chemicals or abrasive cleaners as they may cause damage to the fixture's finish.

Thank you for your purchase
Stores | catalog | www.westelm.com

USA [888-922-4119](tel:888-922-4119)