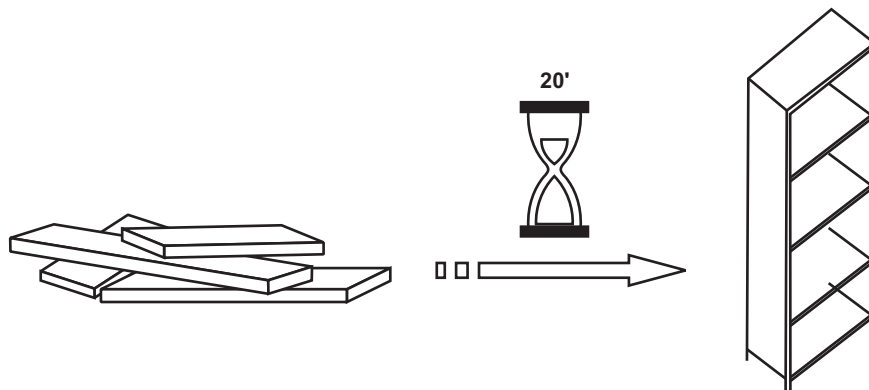

DRUM STORAGE COFFEE TABLE
TABLE BASSE DE RANGEMENT DE TAMBOUR
MESA DE CAFÉ DE ALMACENAMIENTO DE TAMBOR

SKU NO 8831138

**ENGLISH**

Do not dispose of any packaging or contents of the shipping carton until assembly is completed to avoid accidentally discarding small parts or hardware.

FRANÇAIS

Ne jetez rien des produits d'emballage et du contenu de la boîte jusqu'à ce que l'assemblage soit terminé, afin d'éviter de jeter par mégarde de petites pièces ou des morceaux.

ESPAÑOL

Para evitar desechar accidentalmente las partes pequeñas o las piezas de ferretería, no tirar el embalaje o contenido de la caja hasta que el ensamblaje esté completo.

Care Instructions:

Dust often using a clean, soft, dry and lint-free cloth.

When blot spills, wipe with a clean, damp cloth immediately.

We do not recommend the use of chemical cleansers, abrasives or furniture polish on our lacquered finish.

Hardware may loosen over time. Periodically check to make sure all connections are tight. Re-tighten if necessary.

Instructions d'entretien :

Épousseter régulièrement avec un chiffon propre, doux et non pelucheux.

Éponger immédiatement les liquides renversés et essuyer à l'aide d'un chiffon propre et humide.

L'utilisation de produits nettoyants chimiques, d'abrasifs ou d'encaustiques sur nos finitions laquées n'est pas recommandée.

Le matériel de fixation peut se desserrer avec le temps. Vérifiez régulièrement afin de vous assurer que tous les raccords sont bien serrés. Resserrez-les au besoin.

Instrucciones de cuidado:

Limpiar el polvo con un trapo limpio, suave, seco y libre de pelusas.

Secar los derrames de inmediato y limpiar con un trapo limpio y húmedo.

Recomendamos no usar limpiadores químicos, abrasivos o lustramuebles sobre el acabado barnizado.

Las piezas de ferretería pueden aflojarse con el tiempo. Controlar periódicamente que estén bien ajustadas. Si es necesario, volver a ajustarlas.

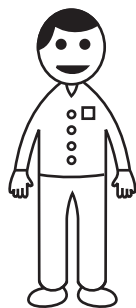

X2

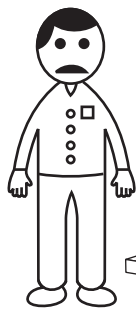
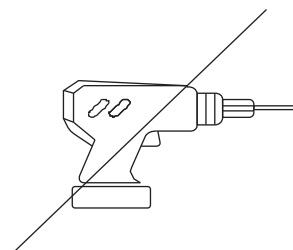
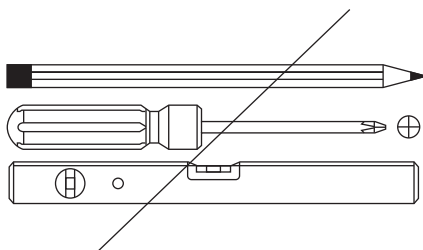

?

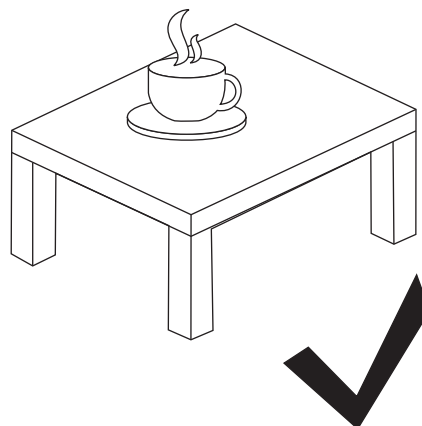
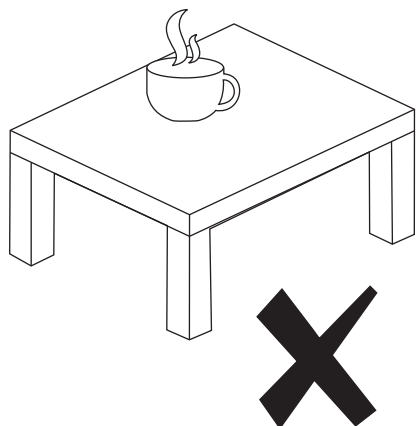
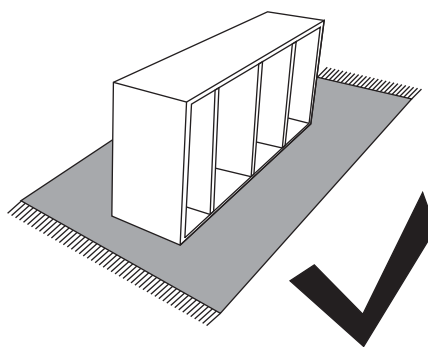
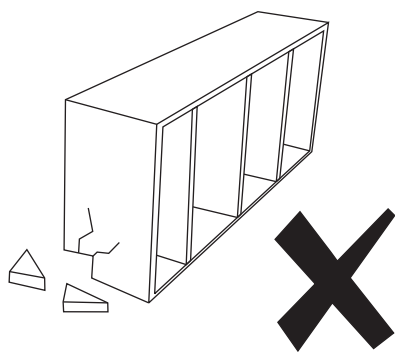
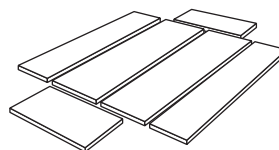
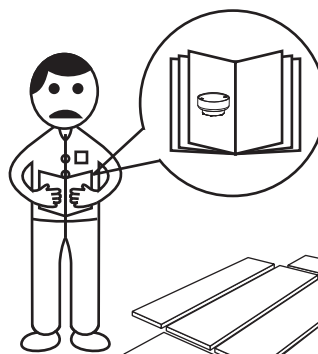
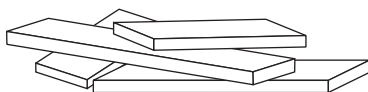
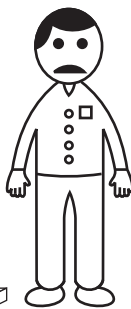

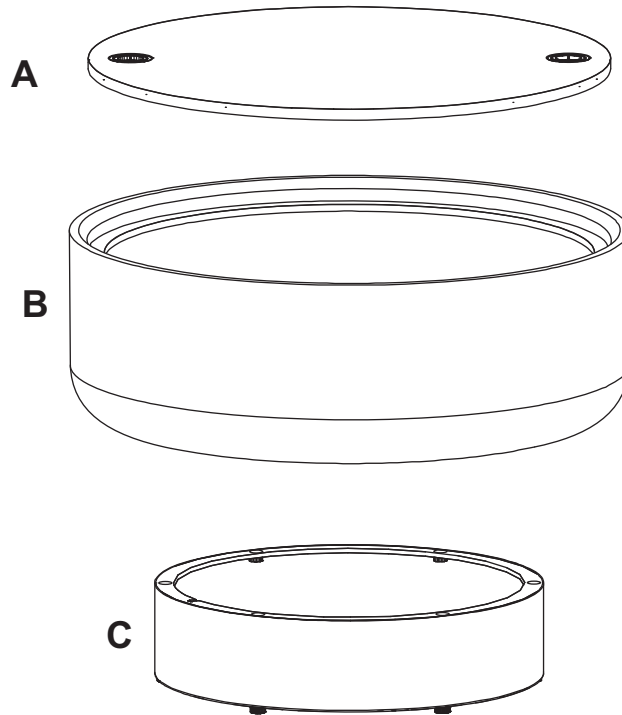

D

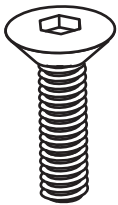

M6 x 20mm
5x

E

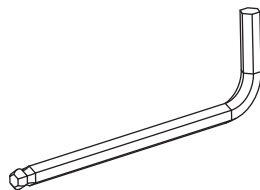

Ø4mm X 110mm
1x

1

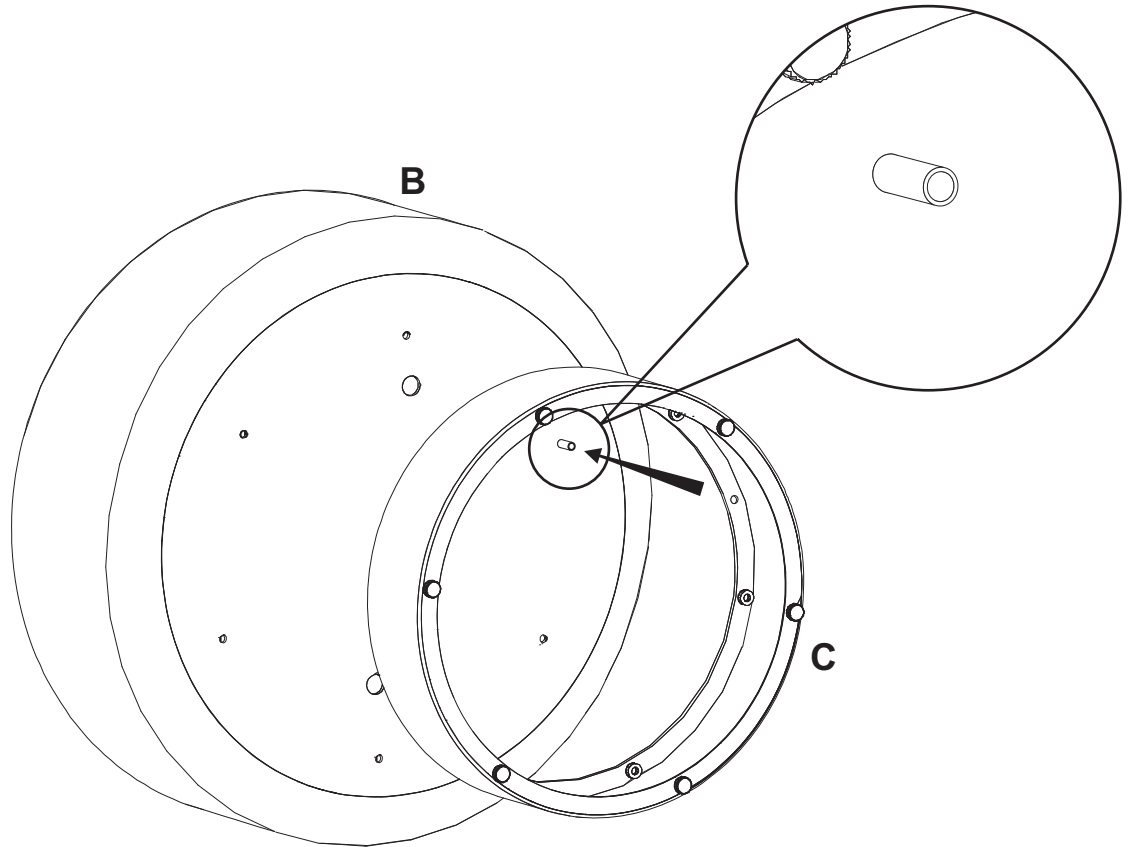

2

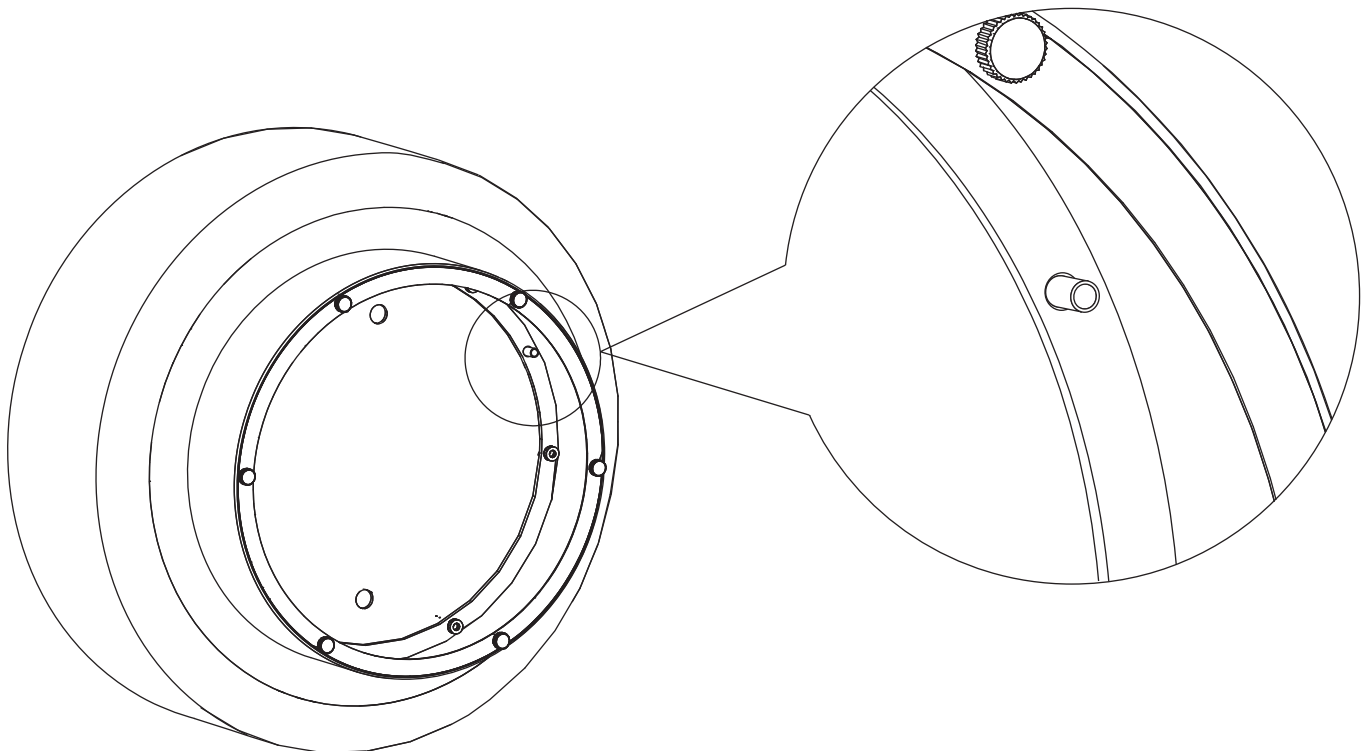

3

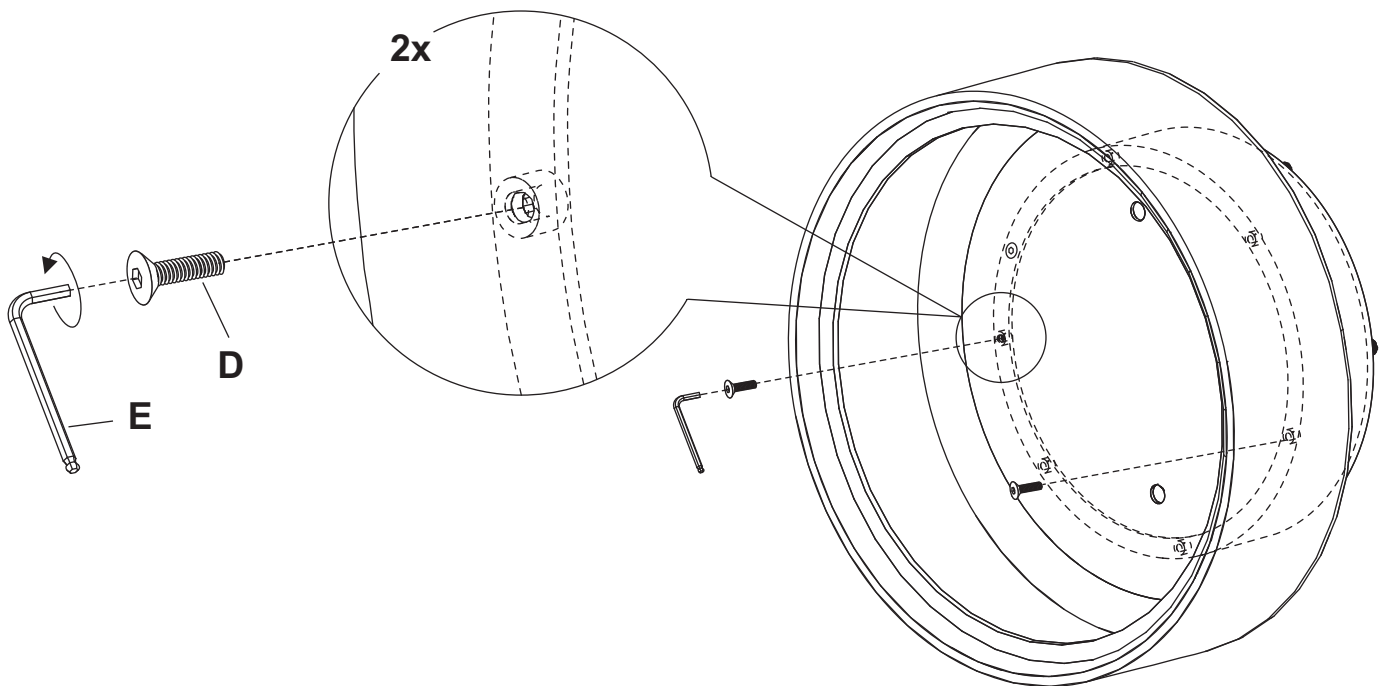
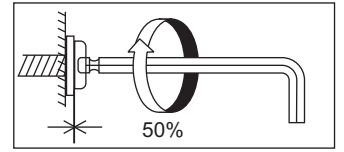

4

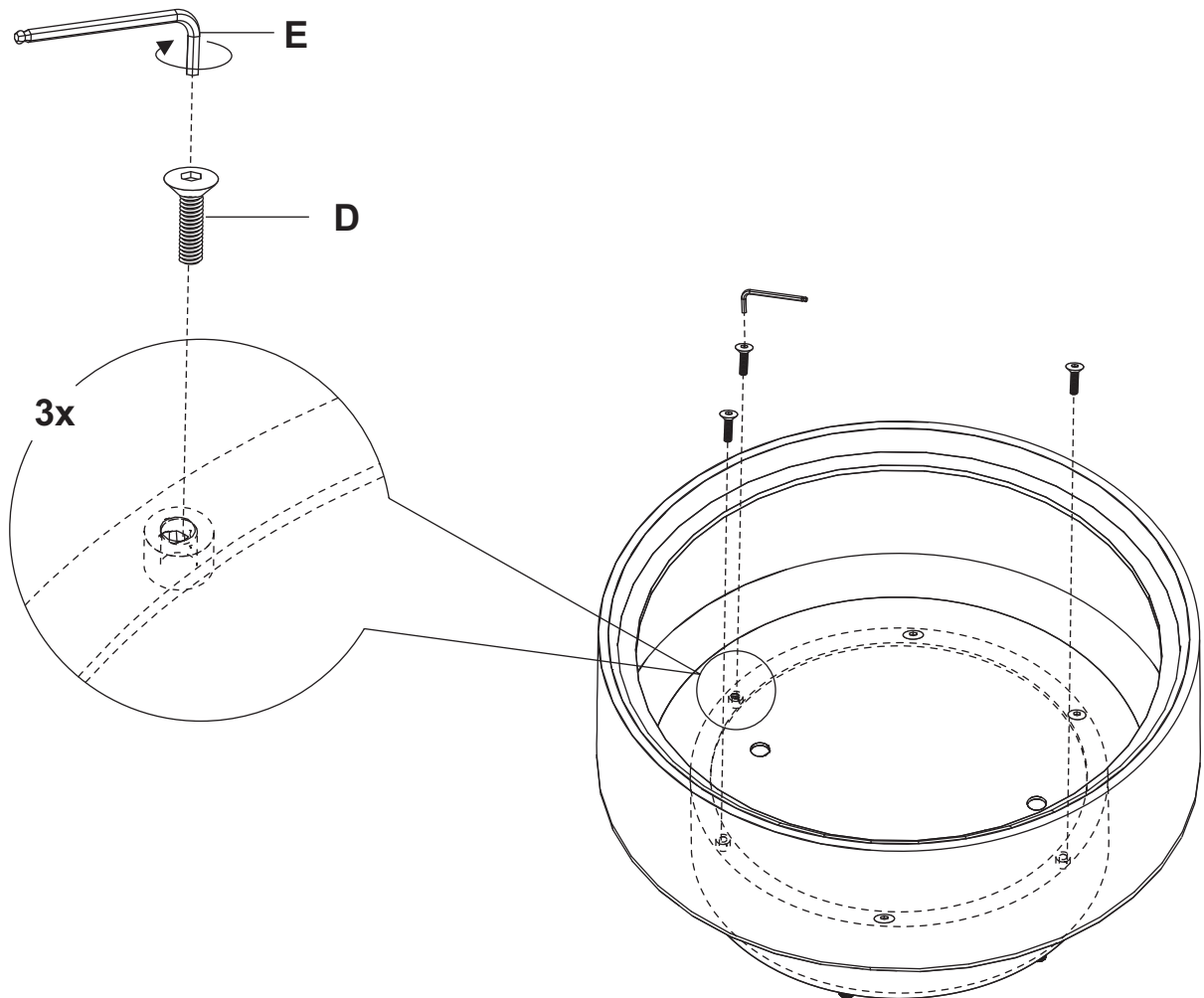
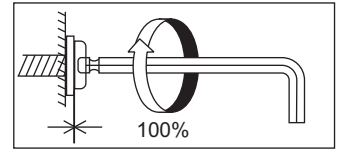

5

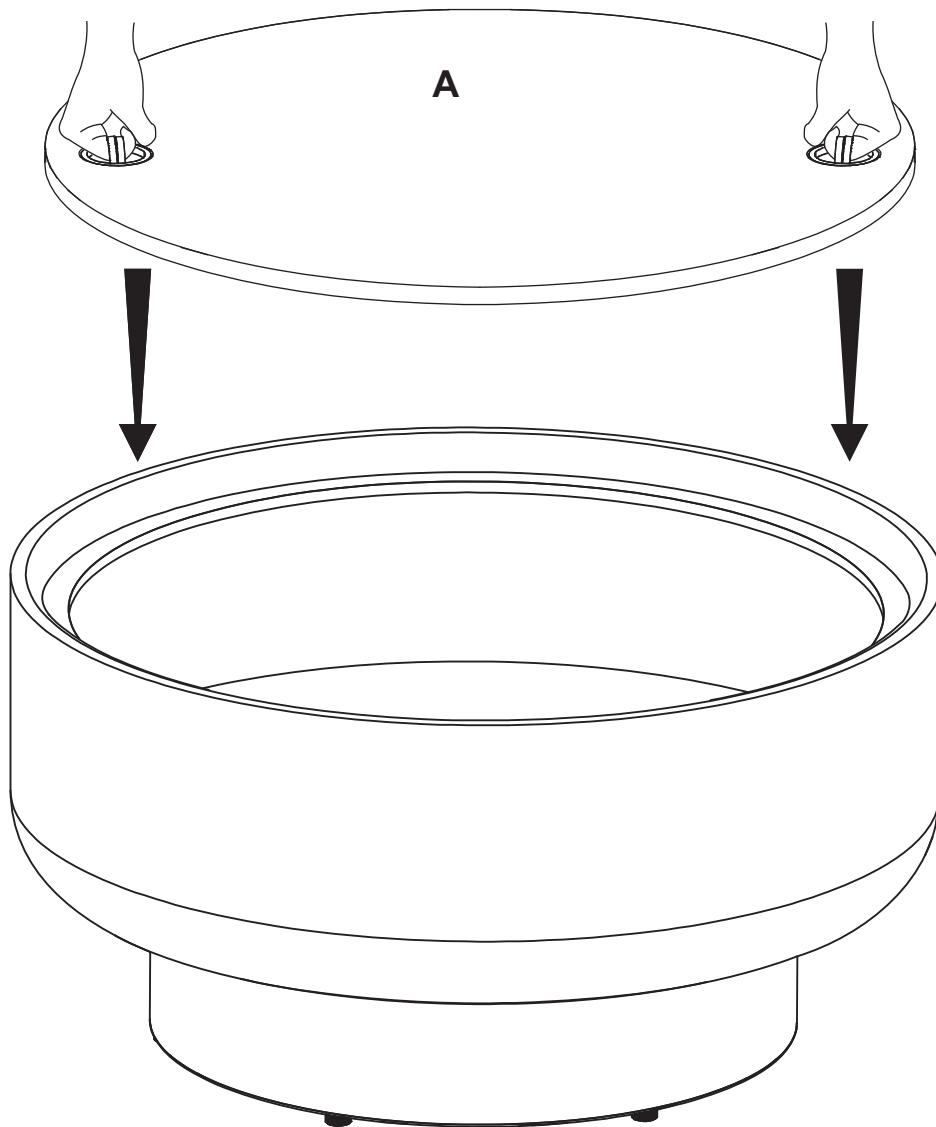

6

