

CAUTION:

- **BEFORE INSTALLING FIXTURE, MAKE SURE THE POWER TO THE CIRCUIT IS TURNED OFF AT THE MAIN FUSE BOX / CIRCUIT BREAKER UTILITY BOX.**

Important Safety Instructions:

- These instructions are provided for your safety. It is very important that they are read carefully and completely before beginning the assembly and installation of this lighting fixture.
- We strongly recommend that a professional electrician install all direct wire fixtures.
- **THIS PRODUCT MUST BE INSTALLED IN ACCORDANCE WITH THE APPLICABLE INSTALLATION CODES BY A PERSON FAMILIAR WITH THE CONSTRUCTION AND OPERATION OF THE PRODUCT AND THE HAZARDS INVOLVED.**
- The lighting fixture is meant for indoor use. It must be connected only to 3-wire, single-phase electrical supply systems (provided with Ground wire or equivalent protection system).
- For your safety, it is strongly recommended that two people install the lighting fixture.
- This fixture has been rated for up to six (6) **60-watt maximum TYPE B standard incandescent light bulbs** (not included) or six (6) **13-watt compact fluorescent light bulbs** (not included). To avoid the risk of fire, do not exceed the recommended wattage.
- The lighting fixture is meant for indoor use, **DRY LOCATIONS ONLY.**
- **Save these instructions.**

WARNING:

- **To reduce the risk of fire, electrical shock or personal injury, always turn off light fixture and allow it to cool prior to replacing light bulb.**
- **Do not touch bulb when fixture is turned on. Do not look directly at lit bulb.**
- **Keep flammable materials away from lit bulb.**
- **This lighting fixture contains lead, a chemical known to the State of California to cause cancer, birth defects and other reproductive harm. Wash hands after installing, handling, cleaning or otherwise touching this light fixture.**

Pre-assembly:

- Remove all parts and hardware from box along with any plastic protective packaging.
- Do not discard any contents until after assembly is complete to avoid accidentally discarding small parts or hardware.
- For your safety and convenience, assembly by two people is recommended.

TOOLS REQUIRED (not included):

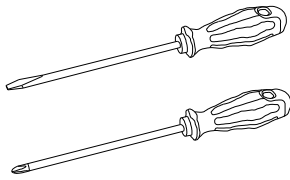
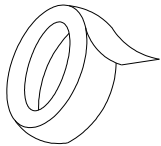
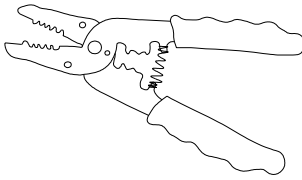
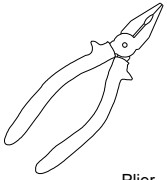

 <p>Step Ladders Escabeaus Escaleras</p>	 <p>Phillips Head, Flat Blade Screwdrivers Tournevis "ϕ" ϕe Phillips et "ϕ" ϕe plate Destornilladores Cabeza Phillips y Destornilladores Cabeza Plana</p>	 <p>Electrical tape Ruban isolant Cinta Electrica.</p>
 <p>Wire Cutter/Stripper Pince coupe-fil/ "ϕ" ϕud" Cortador de Cable</p>	 <p>Plier Pince Alicates</p>	

Parts Included:

- (B) Green Ground Screw (1)
- (D) Mounting Plate (1)
- (E) Canopy Screws (2)
- (F) Canopy (1)
- (G) Ball Joint (1)
- (H) Long Tubes (3)
- (I) Short Tube (1)
- (J) Metal Cap (1)
- (K) Threaded Nipple (1)
- (L) Lamp Body (1)
- (M) Sockets (6)
- (N) Glass Shades (6)
- (O) Metal Spacers (6)
- (P) Socket Rings (6)

Hardware Enclosed:

- (A) Plastic Wire Nut Connectors (3)
- (C) Mounting Screws (2)

<p>A</p>  <p>3x</p>
<p>C</p>  <p>2x</p>

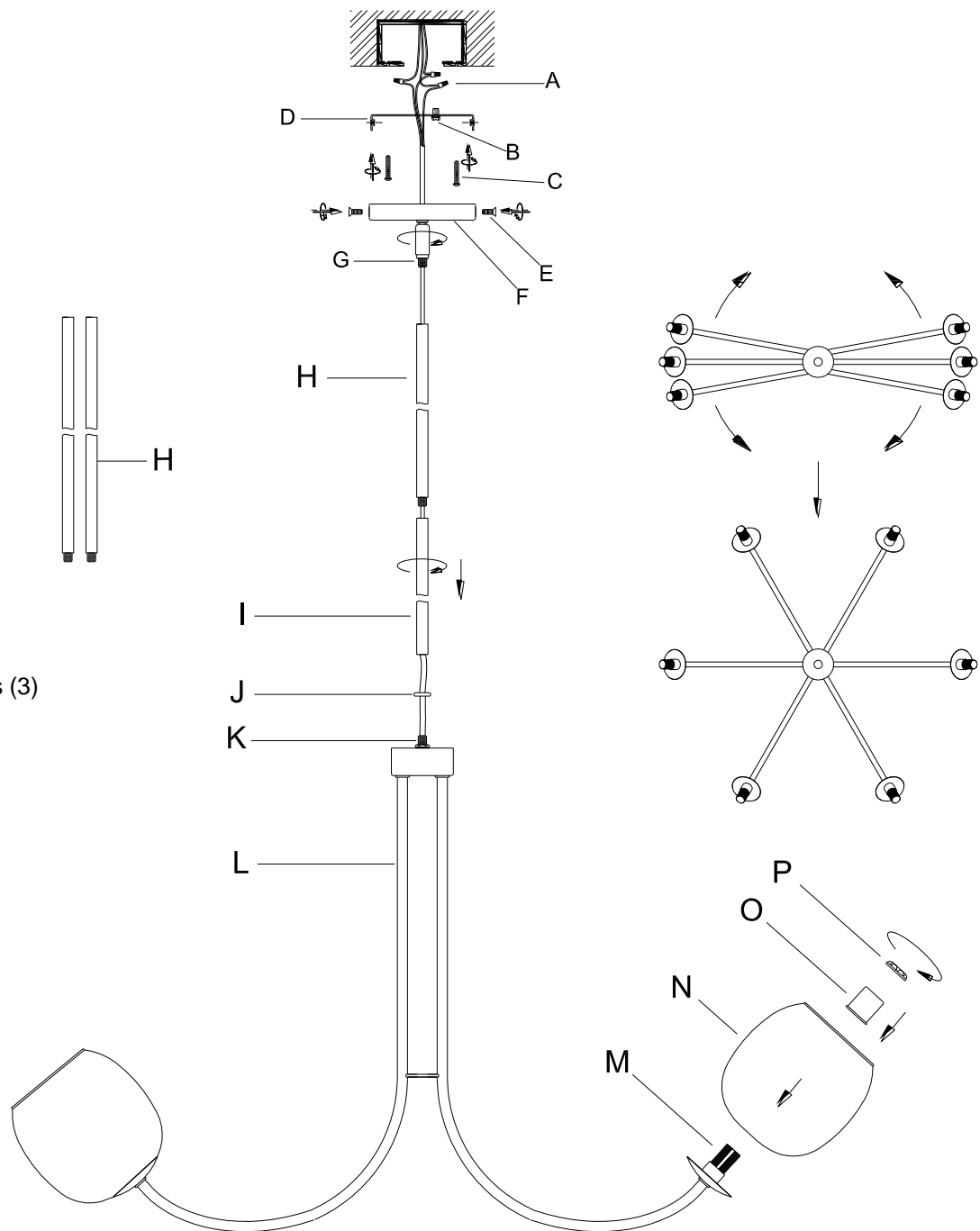

To Adjust the Suspension Length of the Fixture:

- Note: The adjustment or shortening of the lighting fixture's suspension length is only needed if the factory set length is not appropriate for your installation. We recommend that you adjust the proper desired length before cutting the electrical cord. Determine the lighting fixture suspension length from the ceiling for the product installation, allowing the extra cord length for the outlet junction box wire connections as noted below.

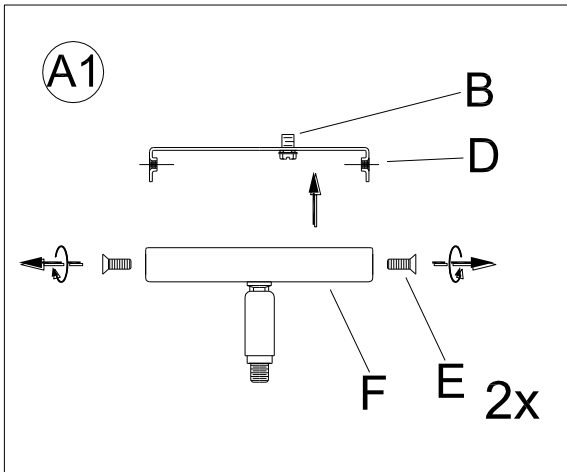

1. Separate the Mounting Plate (D) from the Canopy (F) by removing the 2 Canopy Screws (E). Do not discard the Canopy Screws (E) as these will be used later.

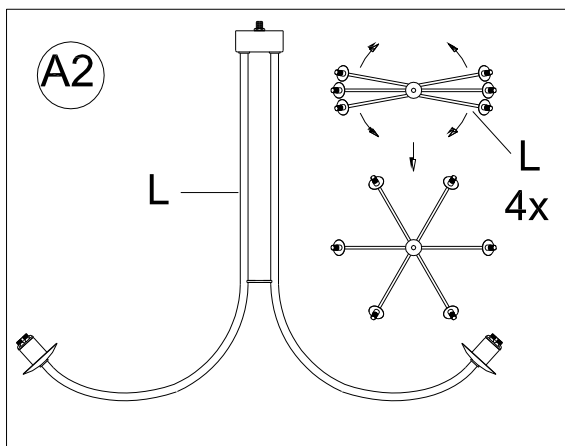

2. Carefully rotate each metal arms into their final position so they are equally spaced as shown in diagram.

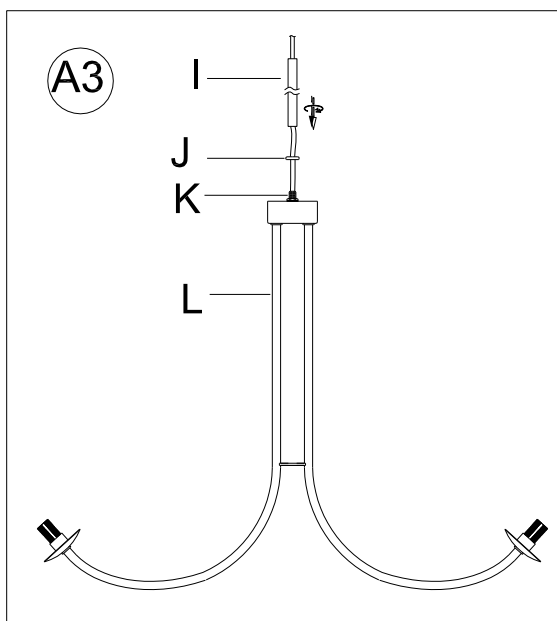

3. Insert the fixture 3 wire power cord through the Short Tube (J), and attach bottom end of the Short Tube (J) onto the Threaded Nipple (K) by turning clockwise until tight.

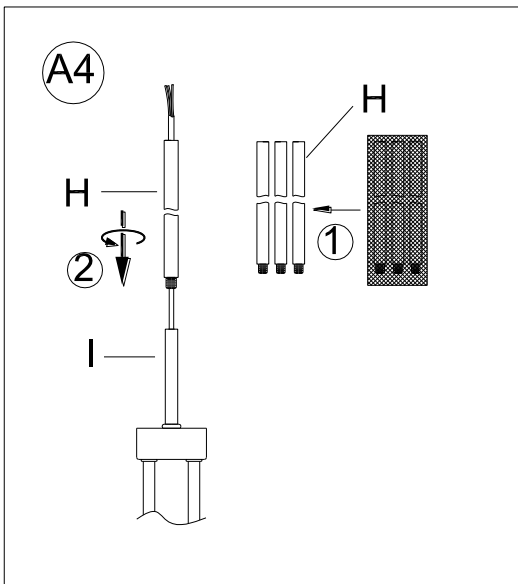

4. If you would like to use only one Long Tube (H), then thread the 3 wire power cord through the Long Tube (H), making sure the tube nipple joint end is downward. Attach the bottom end of Long Tube (H) onto the top end of Short Tube (I) and rotate clockwise until tight. Use the additional Long Tube (H) as needed to adjust the fixture's suspension length by following the similar procedure as outlined in step 1 of this illustration.

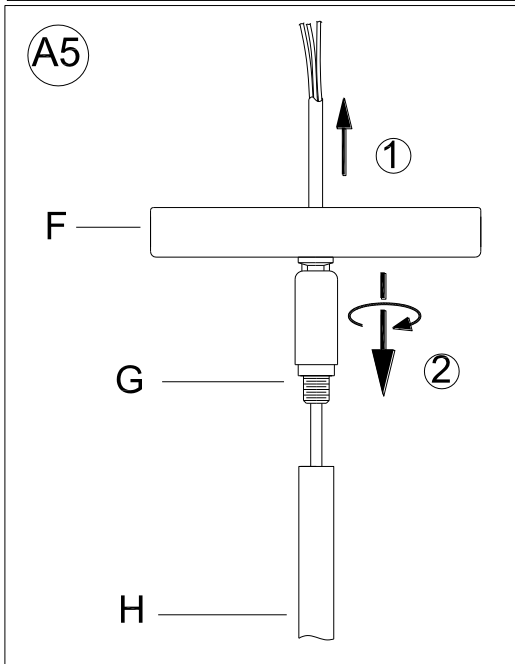

5. Insert the fixture's 3 wire power cord through the Canopy (F). Attach bottom threaded nipple of the Ball Joint (G) onto the top end of assembled Tube (I/H) by rotating two parts clockwise until tight.

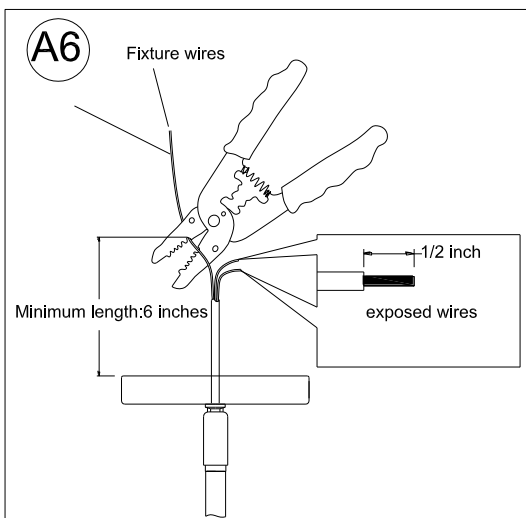

6. If needed, cut off the extra power cord length on the 3 wire cords so that they all are at least 6 inches (152.4 mm) long within the outlet junction box (J-box).

Assembly & Installation Instructions:

- **SHUT OFF THE MAIN ELECTRICAL SUPPLY FROM THE MAIN FUSE BOX/CIRCUIT BREAKER!**
- Carefully unpack all fixture parts and hardware and lay them on a clear workspace.
- If the parts are not already preassembled or if suspension length adjustments were not made, please use the instruction section above “To Adjust the Suspension Length of the Fixture” for the proper assembly of the Tubes (H&I) to the desired suspension length.

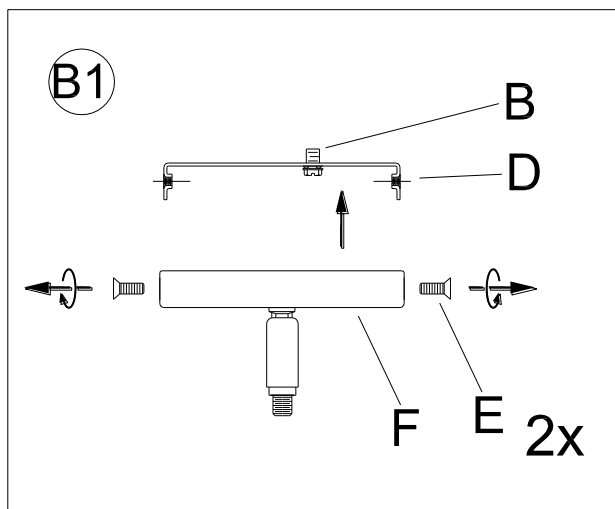

1. Separate the Mounting Plate (D) from the Canopy (F) by removing the 2 Canopy Screws (E). Do not discard the Canopy Screws (E) as these will be used later.

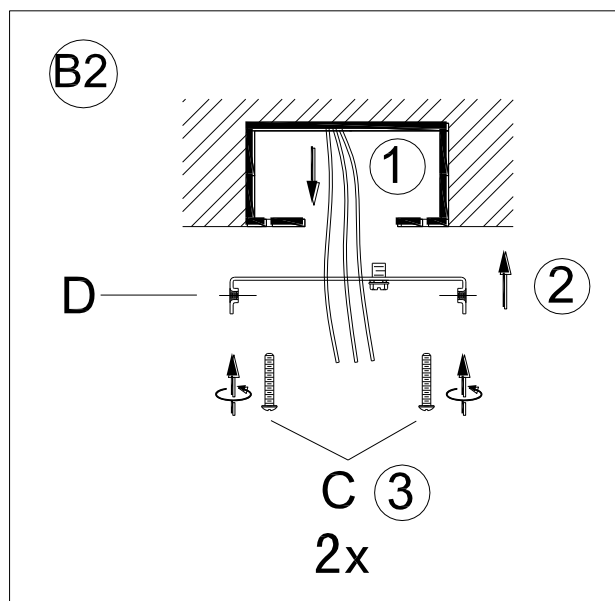

2. Gently pull existing wire down from the ceiling junction box and allow wires to hang. Attach Mounting Plate (D) to the ceiling outlet box. Tighten 2 Mounting Screws (C) with a screwdriver.

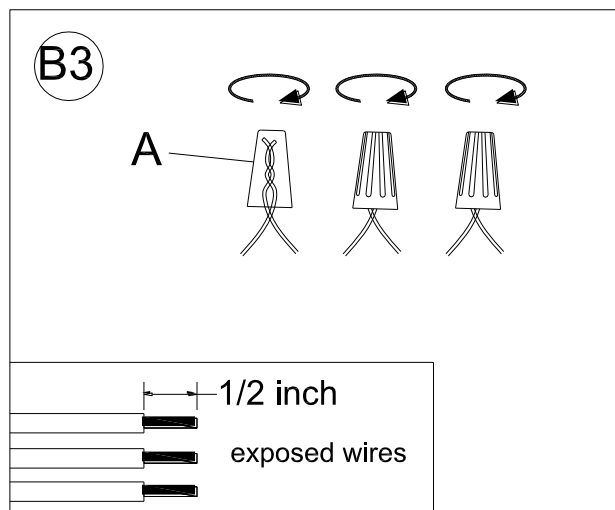

3. Please read the section “To Make the Wire Connections” Below.

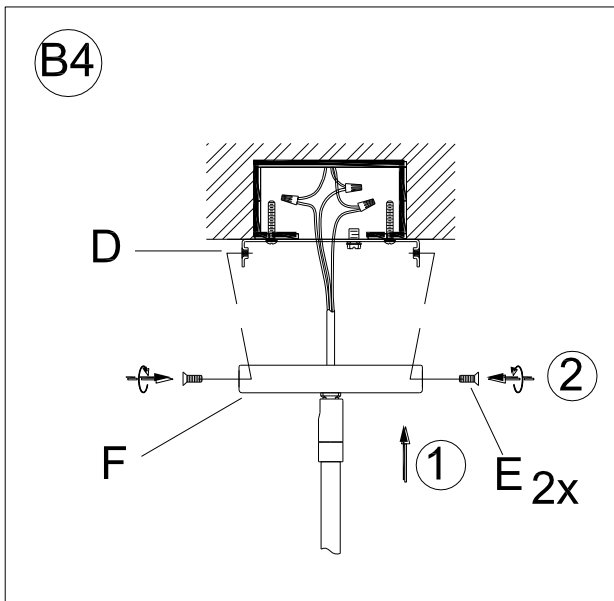

4. Raise Canopy (F) up over the Mounting Plate (D), align the holes on the Mounting Plate (D) with the holes on the side of the Canopy (F). Insert the 2 Canopy Screws (E) and tighten with a screwdriver.

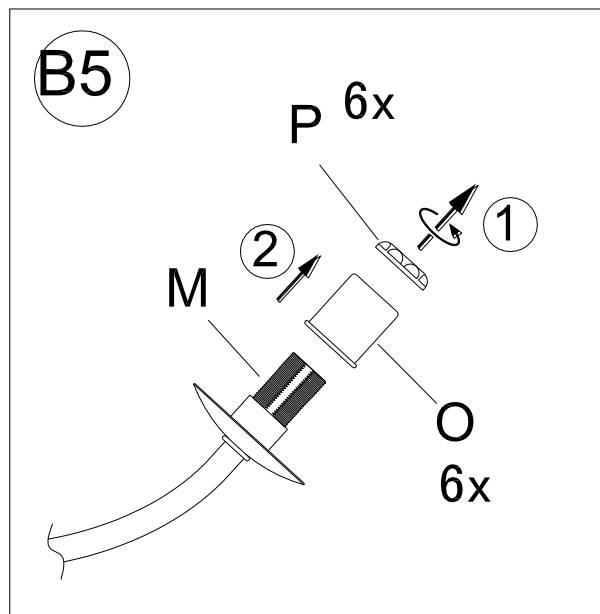

5. Remove Socket Rings (P) and Metal Spacers (O) by turning each Socket Ring (P) from each Socket (M) counter-clockwise, and set them aside.

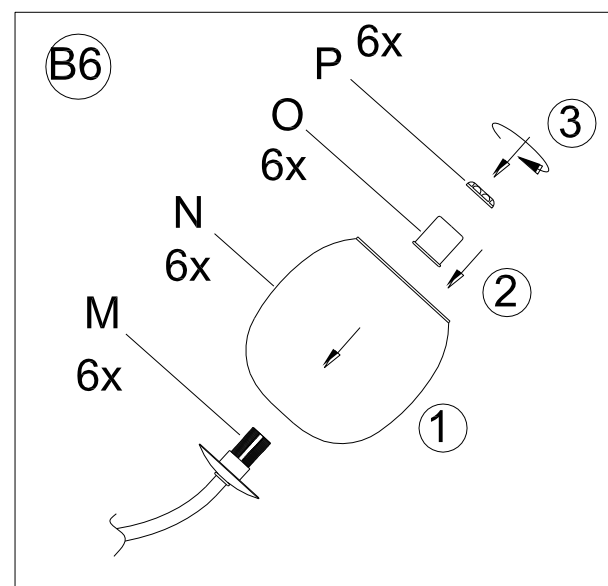

6. Position one Glass Shade (N) over one of the Sockets (M). While holding the Glass Shade (N) in place, place the Metal Spacer (O) onto the Socket (M) first and then turning the Socket Ring (P) clockwise onto the Socket (M) by hand until tight. Do not over tighten. Assemble each of remaining Glass Shades(N) onto each of Sockets (M) using the same procedure as above.

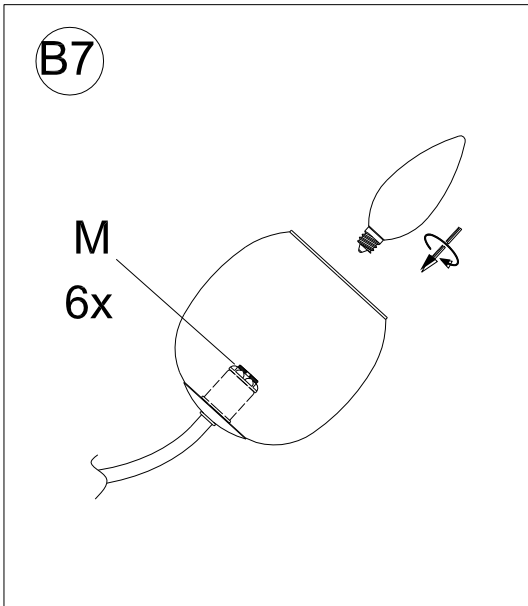

7. Insert the specified light bulbs into the Sockets (M). DO NOT EXCEED THE SPECIFIED WATTAGE.

To Make the Wire Connections:

1. Gently pull existing wire down from the ceiling junction box and allow wires to hang. The HOT or LIVE wire is usually black. The NEUTRAL wire is usually white. Check to see if there is a ground wire that is usually green or green with a yellow stripe or exposed copper metal wire. If needed, use a pair of wire strippers to remove about 1/2 inch of insulation from each wire.
2. Carefully inspect the fixture wires. The NEUTRAL FIXTURE WIRE is White. The HOT FIXTURE WIRE is Black. And the GROUND WIRE is Green. If you have any doubt and cannot identify the power-supply wires with confidence, then we recommend that you ask an electrician and that you not continue with the installation.

3. With the help of another person to hold the weight of the fixture, attach the fixture wires to the junction box wires as shown in the illustrations.

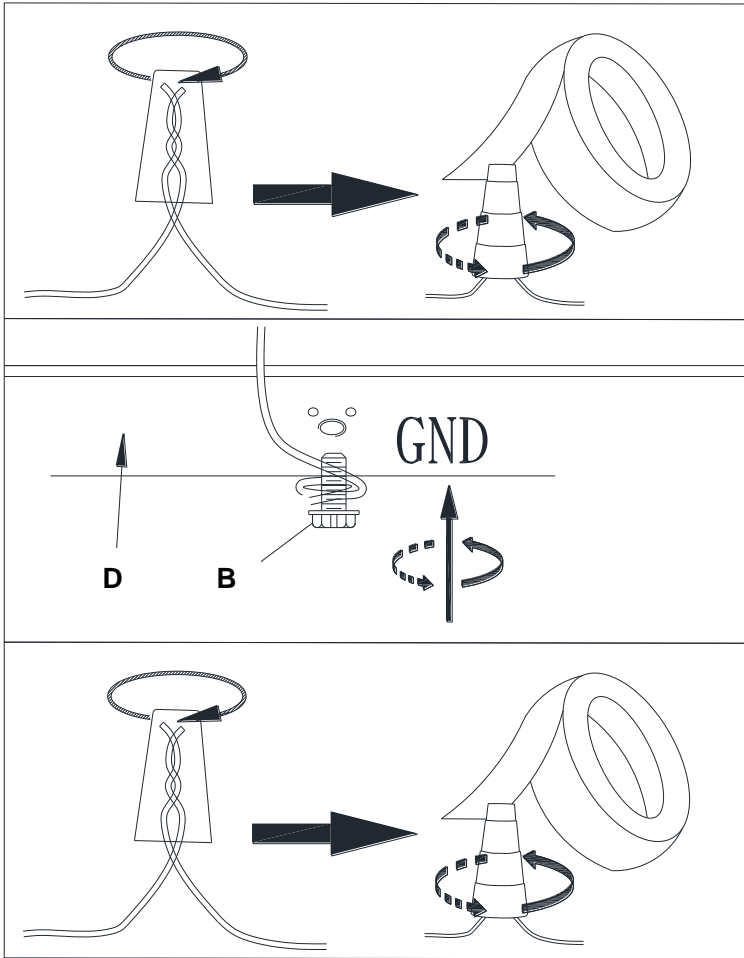

Connect the GROUND FIXTURE WIRE to the GROUND J-BOX WIRE using the Plastic Wire Nut Connector (A) and wrap the connection with electrical tape. Be sure that no wire strands are exposed.

If the junction box DOES NOT have a GROUND WIRE, wrap the fixture's bare ground wire around the Green Ground Screw (B) and insert the screw into the Mounting Plate (D), marked as "GND", and tighten screw to secure the wire.

Connect the NEUTRAL FIXTURE WIRE to the NEUTRAL J-BOX WIRE first and then connect the HOT FIXTURE WIRE to the HOT J-BOX WIRE using the Plastic Wire Nut Connectors (A). Wrap these connections with electrical tape. Be sure that no wire strands are exposed.

NOTE:

**IT IS IMPERATIVE THAT THE JUNCTION BOX IN YOUR HOME BE PROPERLY GROUNDED!
DO NOT REVERSE THE HOT AND NEUTRAL CONNECTIONS OR SAFETY WILL BE COMPROMISED.**

4. Check the wiring connections and if all looks good, gently tuck the wire connections neatly into the ceiling junction box

Care instructions:

- Wipe clean with a soft, dry cloth or static duster.
- Always avoid the use of harsh chemicals or abrasive cleaners as they may cause damage to the fixture's finish.

Thank you for your purchase
Stores | catalog | www.westelm.com
USA 888-922-4119