







PRE-ASSEMBLY:

- Remove all parts and hardware from carton box along with any plastic protective packaging.
- Do not discard any contents until after assembly / installation is completed to avoid accidentally discarding small parts or hardware.
- For safety and ease of mounting, two-people working together is recommended.
- Please read all instructions before beginning assembly and save these instructions for future use.

NOTE: The mounting hardware provided is meant for drywall / stud mounting only. Try to mount to wood studs whenever possible. For safe mounting, it is essential to use the proper hardware for your wall type. Contact your local hardware store for assistance for any other wall type if necessary.

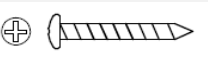
TOOLS NEEDED (not included):

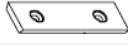
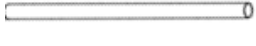
- Philips Screwdriver
- Stud-Finder
- Pencil
- Carpenter's Level
- Tape Measure

Parts Included:		Hardware Enclosed:	
(D) Finials (2)		(A) Drywall Anchors (6)	
(E) Bracket* (2)		(B) Metal Screws (6)	
(F) Bracket* (1)		(C) Allen Key (1)	
(G) Mounting Plates (3)			
(H) Large End Rod (1)			
(I) Large Central Rod (1)			
(J) Small Rod (1)			

* The Bracket (E) includes a large ring for holding the Large Rod (H / I).

* The Bracket (F) includes a small ring for holding the Small Rod (J).

ROD ASSEMBLY INSTRUCTIONS:

- There are three rod sections - TWO larges & ONE small. All these rod sections are shipped separately and must be assembled before mounting to form a long single telescoping rod assembly.
- First, insert the Large Central Rod (I) into the Large End Rod (H), then insert the Small Rod (J) into the Large Central Rod (I).

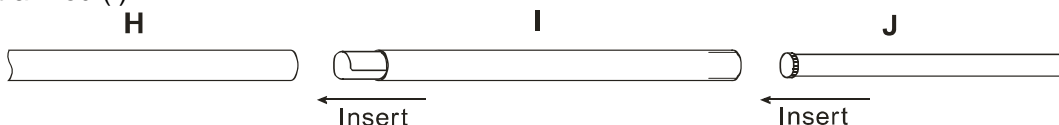

- Please note that the small rod includes an insertion end that has a plastic bushing and an opposing finial end that includes a threaded hole. To assembly, with one hand holding the Larger Central Rod (I), use another hand to hold the Small Rod (J) together with the plastic bushing and then carefully insert into the Larger Central Rod (I), see illustration shown below. The plastic bushing will keep the two rods from scratching.

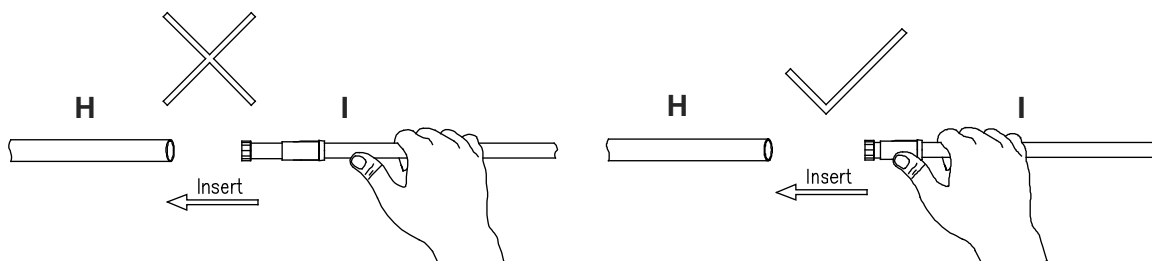

INSTALLATION INSTRUCTIONS:

1. Determine a desired mounting location over a window frame and then use a tape measure, a level or a laser line level and a pencil to make a level line that extends along the entire width of the window or door frame and a predetermined distance above it, as shown by arrow "A" in the illustration below. For the maximum amount of light, we recommend that the brackets be positioned on each side of the window frame a distance "B" so that the curtains can be drawn open completely. The exact position of the bracket (with its mounting plate) will depend on the width of the curtain when gathered closed. You can attach a curtain to one of the assembled but not yet mounted rod assemblies to determine the distance "B", as shown in the illustration.
2. Take out the Mounting Plates (G) from the included part pack. Align a mounting plate at your calculated position using distances "A" and "B". While holding the mounting plate vertically straight and steady, use a pencil to mark the wall through the top hole and the bottom hole of the mounting plate and then repeat this step with the other mounting plate on the opposing side of the window. Position the third bracket at the center point of the window and align it with the horizontal line of Step (1). Again, use a pencil to mark the wall through the holes of this central mounting plate and then set the mounting plate aside.
3. If any of the mounting plate hole marks of Step (2) aligns with an internal wall stud (use a stud finder to determine this), use only a provided Screw (B) at that mark - do not use the anchor. When instructed to do so below, skip to step 5.
4. For marks that do not align with a stud, use both the anchor (A) and the screw (B). To install the anchor, use a Phillips screwdriver to engage the anchor and then position the anchor tip against the wall at one of the marks. Rotate the anchor clockwise as you firmly push it into the wall. The anchor will drive itself into the wall like a large screw. Continue rotating until the large flange of the anchor becomes even with the wall surface. Do not over-tighten.
5. Return one of the Mounting Plates (G) to its mounting position so the holes align with either an installed anchor or a pencil mark (if the mark happened to align with a stud). Use a screwdriver to secure a Screw (C) through each mounting plate hole and into either the anchor or the wall stud. Rotate the screw clockwise until tight. Repeat this step with the other mounting plates.
6. Slide the Brackets (E & F) onto each installed mounting plates. Keep in mind that the one of the brackets has a small ring for holding the small rod sections and the other two brackets has a larger ring for holding the larger rod section. Align the brackets so they will fit the rod sections smoothly. Adjust if necessary.
7. Carefully slide the rod assembly (H & I & J) through each of the mounted brackets and extend the different rod sections as necessary to position the rod evenly on your window. Depending on how your drapes or curtains are secured to the rod assembly (straps, rings, clips etc.), you may have to attach the drapes to the rod simultaneously as you slide the rod assembly through each bracket.
8. Use the provided Allen key (C) to tighten each set screw that located at each bracket (E & F) to secure the rods in place.
9. Attach a Finial (D) at each end of the rod assembly by threading the stud of the finial into the threaded hole in the rod end. Rotate the finial clockwise with one hand while holding the rod firmly with your other hand. Hand-tighten only.

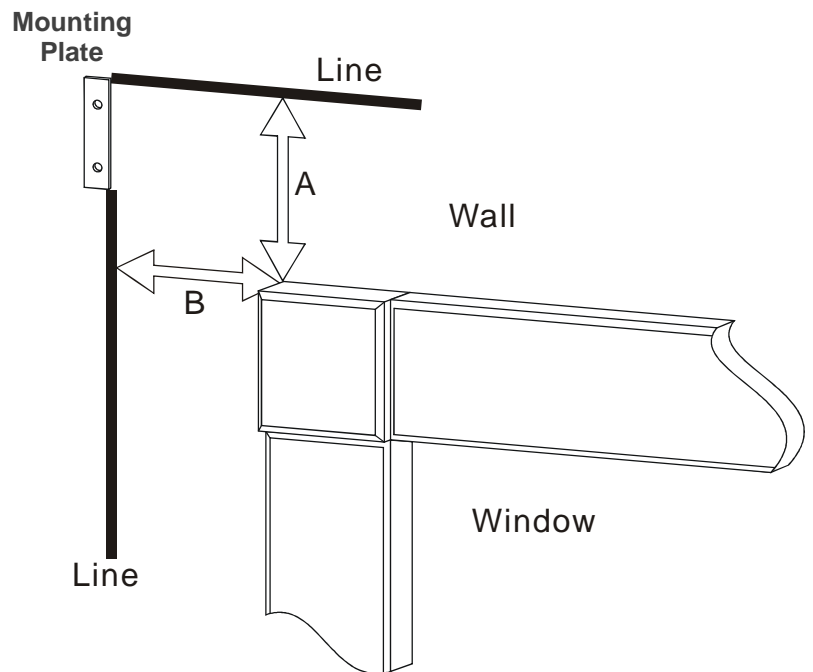

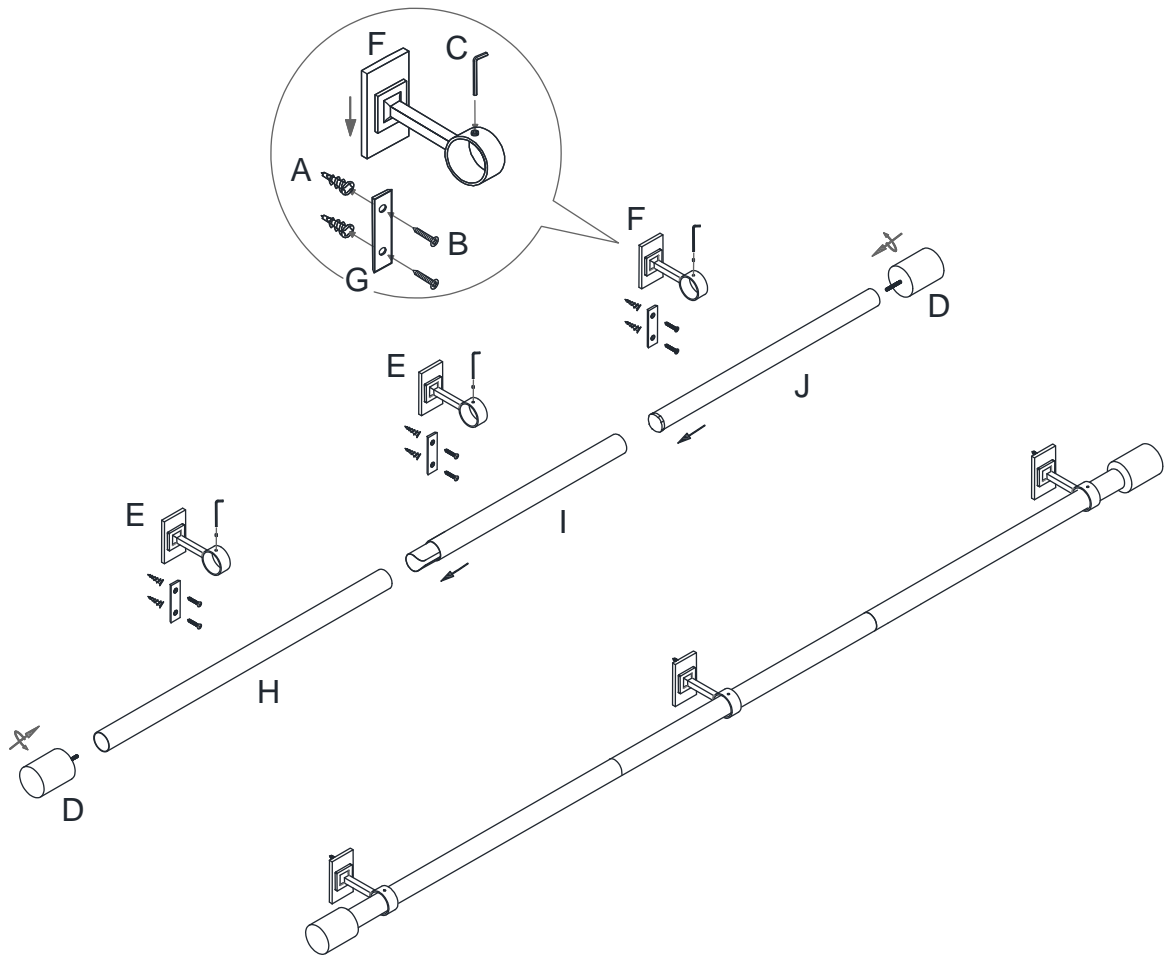

HANGING THE CURTAINS (Curtain is not included with this item):

- Pole Pocket/Grommet Top Curtains – Remove Finial (D) from either end of rod to slide curtains onto the assembled rods.
- Drapery Hooks/Tie Top Curtains – For drapes with drapery hooks or tie tops, hang each hook or tie each tie directly onto the rods.
- Curtain Rings - Remove Finial (D) from either end of rods to slide curtain rings onto the assembled rods. Secure the drapes or sheer directly to the rings.

CARE INSTRUCTIONS:

- Clean with a soft, dry or slightly damp cloth.
- To protect the finish, do not apply with household cleaners or abrasives.

Thank you for your purchase!
Stores | catalog | www.westelm.com