

4 TIER
4 NIVEAUX
4 NIVELES

 **“WARNING! DO NOT MOUNT THIS ITEM ABOVE CRIBS, BEDS, OR CHANGING TABLES.”**

 **ATTENTION! NE PAS MONTER CET ARTICLE OU-DESSUS DU BERCEAUX, LITS, OU TABLES À LANGER.**

 **ADVERTENCIA! NO MONTE ESTE ARTÍCULO ARRIBA CUNAS, CAMAS, O MESAS PARA CAMBIAR PAÑALES.**

Maximum total weight capacity for this product is 100 pounds (45.4 Kg)
Capacité de poids total maximum pour ce produit est de 100 livres (45.4 kg)
Capacidad de peso máximo total para este producto es de 100 libras (45.4 kg)

Maximum load of each shelf is 25 pounds (11.3 Kg)
La charge maximale de chaque tablette est de 25 livres (11.3 kg)
La carga máxima de cada estante es de 25 libras (11.3 Kg)

ENGLISH

- Do not dispose of any packaging or contents of the shipping carton until assembly is completed to avoid accidentally discarding small parts or hardware.
- This unit must be fixed to the wall.
- Enclosed fasteners are for drywall only.
- Use fixing devices suitable for the walls in your home. Please contact your hardware store if you are uncertain about what type of screw or hardware to use.

FRANÇAIS

- Ne jetez rien des produits d'emballage et du contenu de la boîte jusqu'à ce que l'assemblage soit terminé, afin d'éviter de jeter par mégarde de petites pièces ou des morceaux.
- Cet article doit être fixé au mur.
- Les attaches fournies sont pour le cloison sèche seulement.
- L'utilisation des dispositifs de fixation qui sont appropriés pour votre domicile. Communiquer avec la quincaillerie locale en cas d'incertitude concernant le type de vis ou le matériel à utiliser.

ESPAÑOL

- Para evitar desechar accidentalmente las partes pequeñas o las piezas de ferretería, no tirar el embalaje o contenido de la caja hasta que el ensamblaje esté completo.
 - Esta unidad se debe fijar a la pared.
 - Los sujetadores incluidos son solamente para muro seco.
 - Utilizar dispositivos de fijación aptos para las paredes de su casa. Comuníquese con su ferretería si no está seguro sobre el tipo de tornillo o herraje que debe usar.
-

Care Instructions:

- Dust often using a clean, soft, dry and lint-free cloth.
- When blot spills, wipe with a clean, damp cloth immediately.
- We do not recommend the use of chemical cleansers, abrasives or furniture polish on our lacquered finish.
- Hardware may loosen over time. Periodically check to make sure all connections are tight. Re-tighten if necessary.

Instructions d'entretien :

- Éponseter régulièrement avec un chiffon propre, doux et non pelucheux.
- Éponger immédiatement les liquides renversés et essuyer à l'aide d'un chiffon propre et humide.
- L'utilisation de produits nettoyants chimiques, d'abrasifs ou d'encaustiques sur nos finitions laquées n'est pas recommandée.
- Le matériel de fixation peut se desserrer avec le temps. Vérifiez régulièrement afin de vous assurer que tous les raccords sont bien serrés. Resserrez-les au besoin.

Instrucciones de cuidado:

- Limpiar el polvo con un trapo limpio, suave, seco y libre de pelusas.
- Secar los derrames de inmediato y limpiar con un trapo limpio y húmedo.
- Recomendamos no usar limpiadores químicos, abrasivos o lustramuebles sobre el acabado barnizado.
- Las piezas de ferretería pueden aflojarse con el tiempo. Controlar periódicamente que estén bien ajustadas. Si es necesario, volver a ajustarlas.

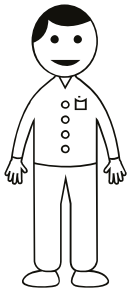

X2

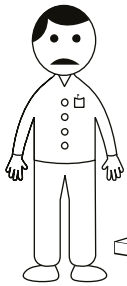
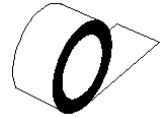
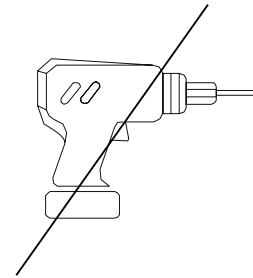
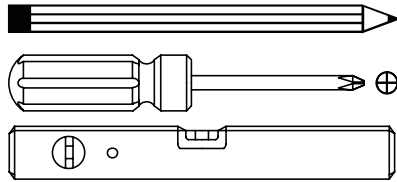

?

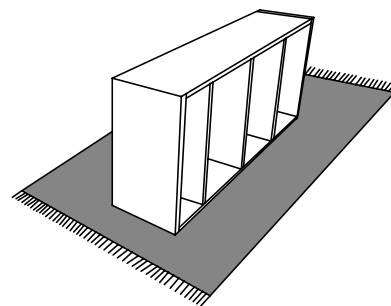
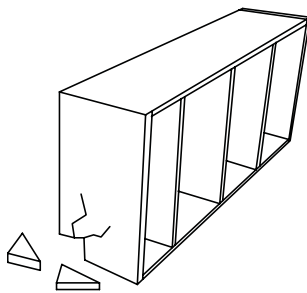
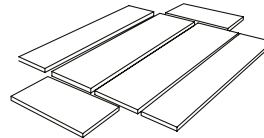
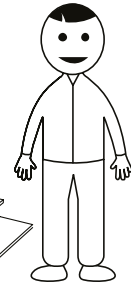
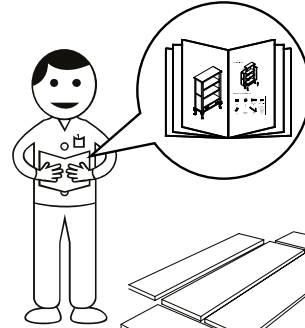
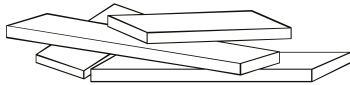
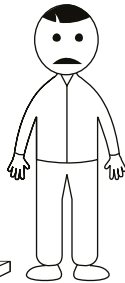

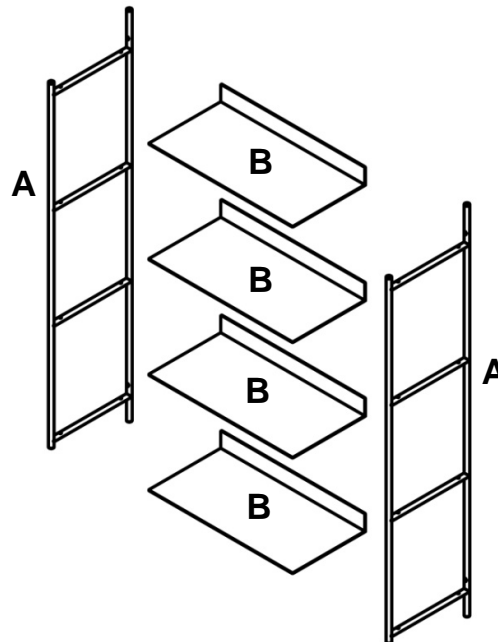

Mounting Template

1x

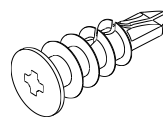

4x



Ø8 x 1¼"

4x

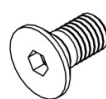

M5 X 10

16x

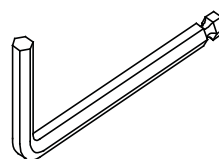

1x

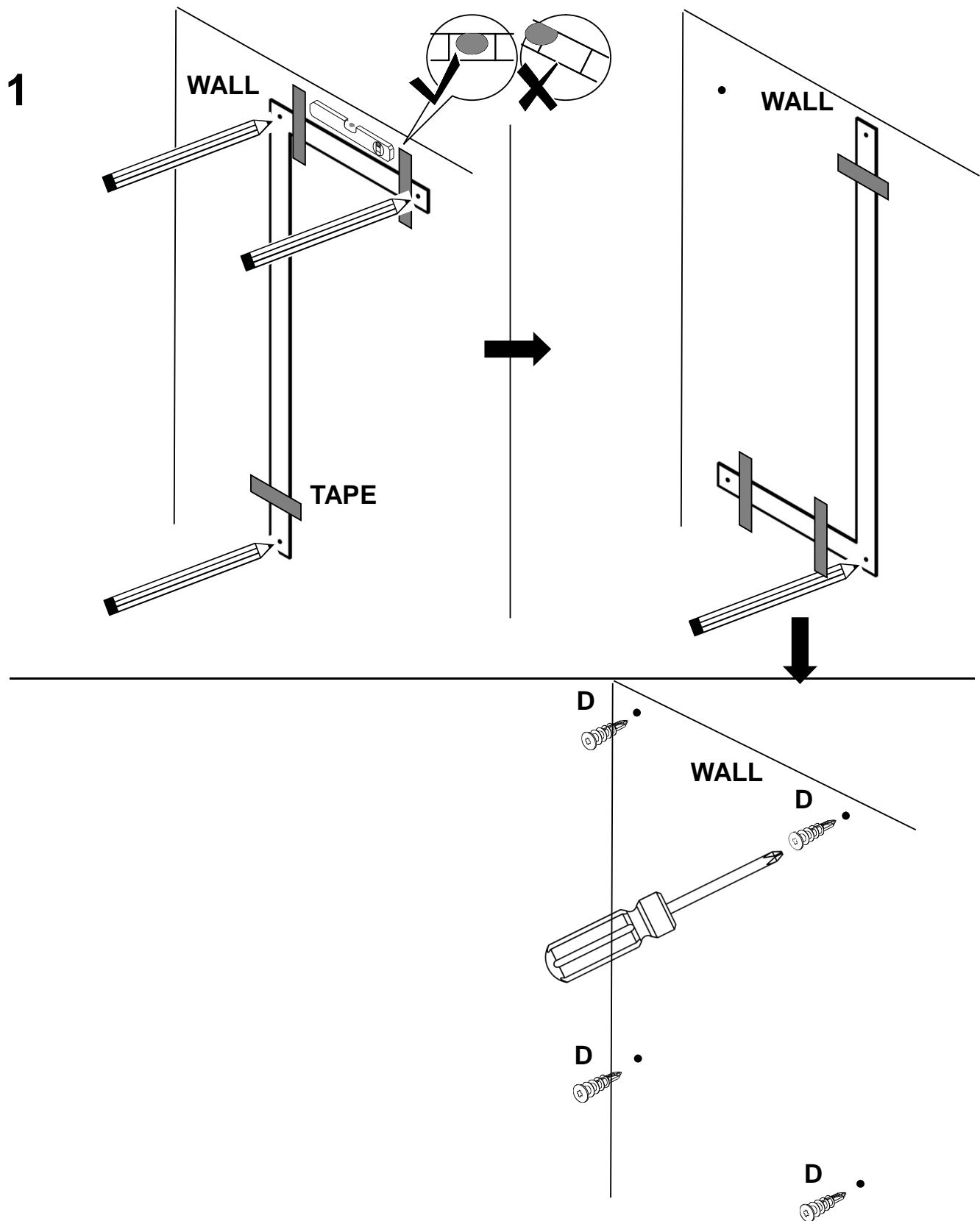

2

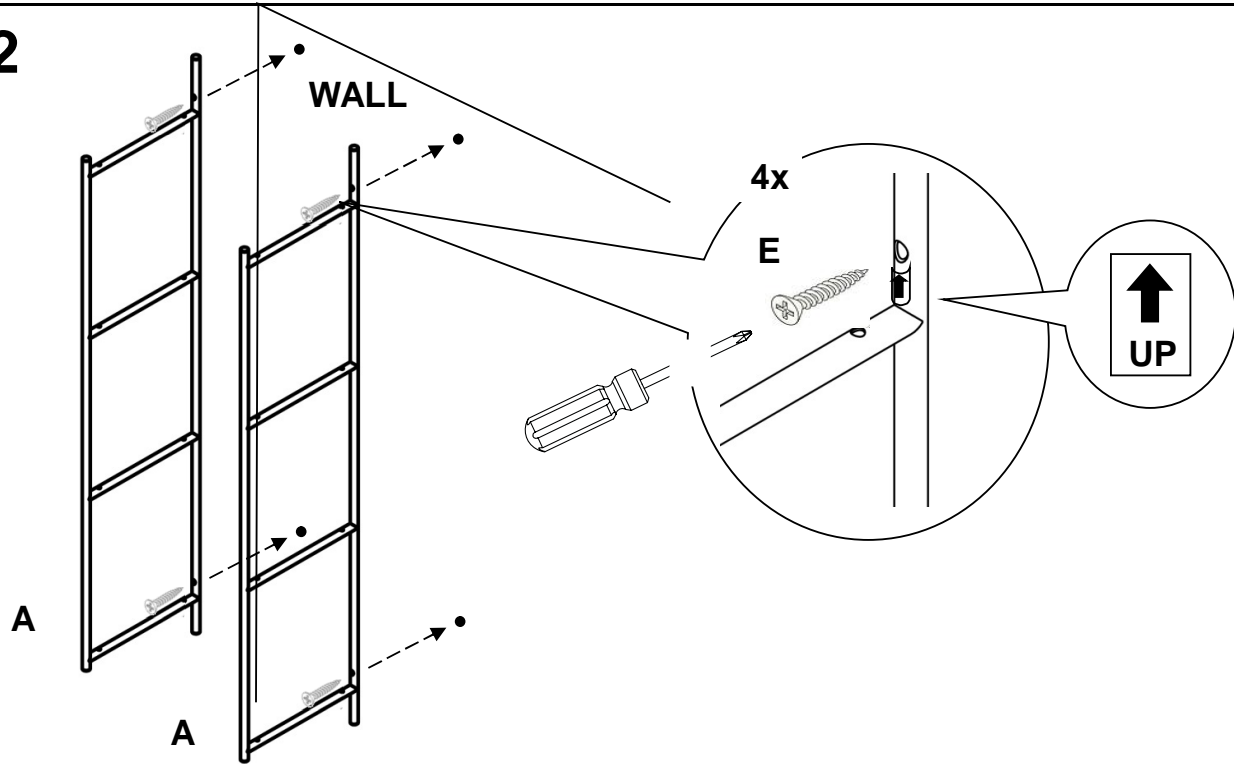

3

