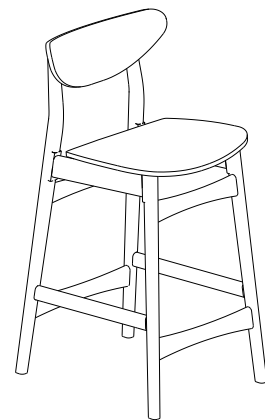
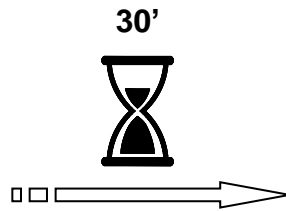
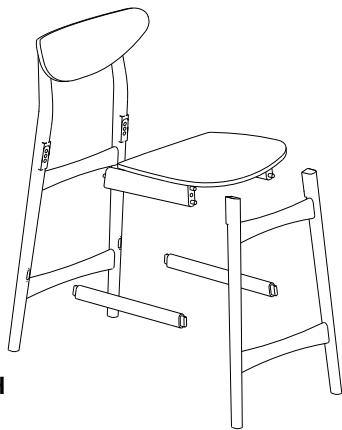

Classic Café Bar + Counter Stools
TABOURET BAR & TABCOMPTOIR CAFÉ CLASSIQUE
TABURETE DE BAR & TABCOUNTER CAFÉ CLÁSICO

**! ENGLISH**

- Do not dispose of any packaging or contents of the shipping carton until assembly is completed to avoid accidentally discarding small parts or hardware.

! FRANÇAIS

- Ne jetez rien des produits d'emballage et du contenu de la boîte jusqu'à ce que l'assemblage soit terminé, afin d'éviter de jeter par mégarde de petites pièces ou des morceaux.

! ESPAÑOL

- Para evitar desechar accidentalmente las partes pequeñas o las piezas de ferretería, no tirar el embalaje o contenido de la caja hasta que el ensamblaje esté completo.

Care Instructions:

- Dust often using a clean, soft, dry and lint-free cloth.
- When blot spills, wipe with a clean, damp cloth immediately.
- We do not recommend the use of chemical cleansers, abrasives or furniture polish on our lacquered finish.
- Hardware may loosen over time. Periodically check to make sure all connections are tight. Re-tighten if necessary.

Instructions d'entretien :





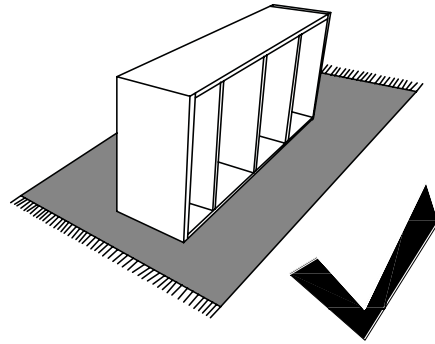
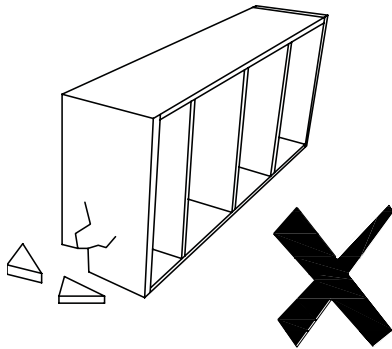
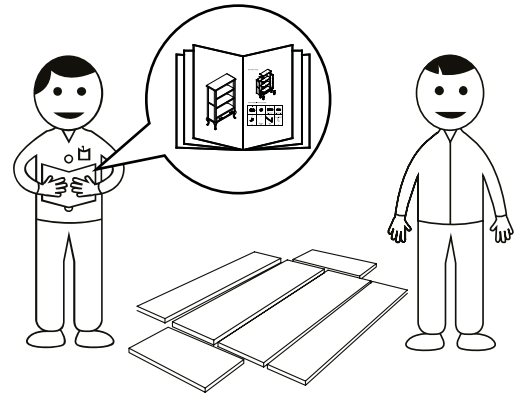
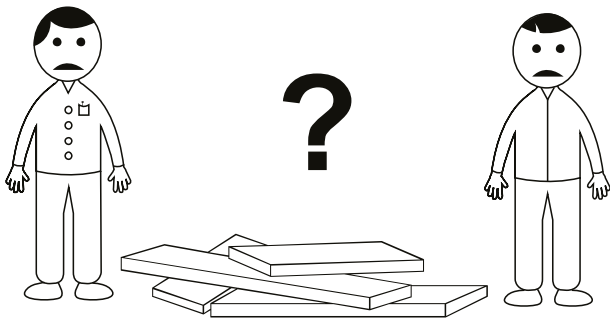
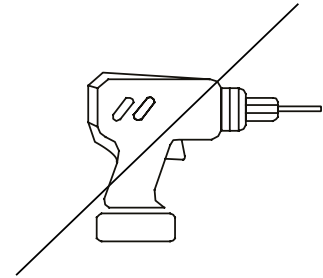
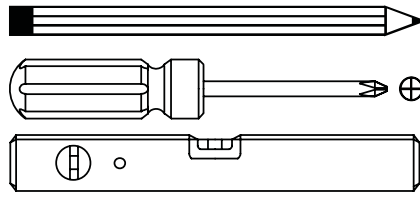
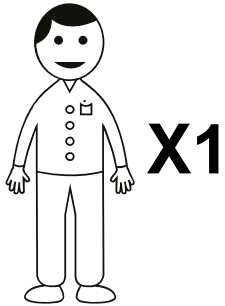

- Épousseter régulièrement avec un chiffon propre, doux et non pelucheux.
- Éponger immédiatement les liquides renversés et essuyer à l'aide d'un chiffon propre et humide.
- L'utilisation de produits nettoyants chimiques, d'abrasifs ou d'encaustiques sur nos finitions laquées n'est pas recommandée.
- Le matériel de fixation peut se desserrer avec le temps. Vérifiez régulièrement afin de vous assurer que tous les raccords sont bien serrés. Resserrez-les au besoin.

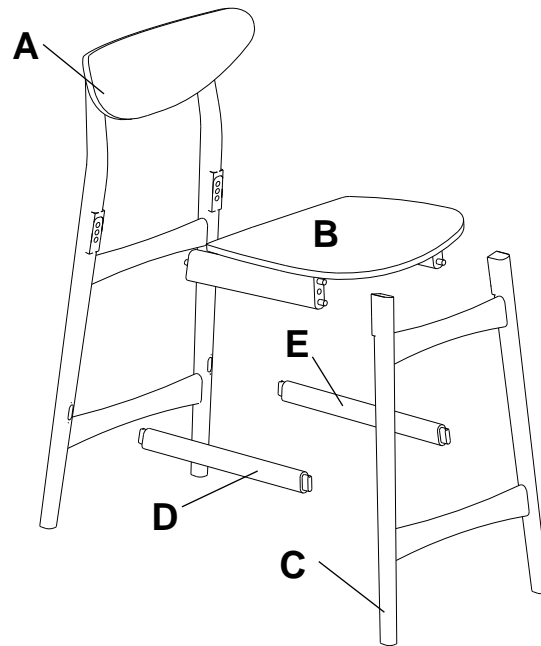
Instrucciones de cuidado:

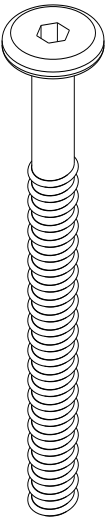
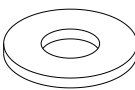
- Limpiar el polvo con un trapo limpio, suave, seco y libre de pelusas.
- Secar los derrames de inmediato y limpiar con un trapo limpio y húmedo.
- Recomendamos no usar limpiadores químicos, abrasivos o lustramuebles sobre el acabado barnizado.
- Las piezas de ferretería pueden aflojarse con el tiempo. Controlar periódicamente que estén bien ajustadas. Si es necesario, volver a ajustarlas.



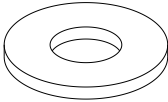

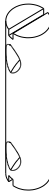
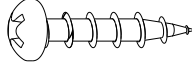
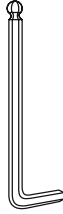
- | | | | | | |
|---|---|---|--|---|---|
| F | G | H | I | J | K |
|  |  |  |  |  |  |
| $\text{\O} 1/4'' \times 3''$ | $\text{\O} 1/4'' \times \text{\O} 3/8''$ | $\text{\O} 1/4'' \times \text{\O} 1/2''$ | $\text{\O} 3/8'' \times 2 1/2''$ | 2x | $\text{\O} 3/8'' \times \text{\O} 5/8''$ |
| 4x | 4x | 4x | 2x | | 2x |
| | L | M | N | P | |
| |  |  |  |  | |
| | $\text{\O} 3/8'' \times \text{\O} 1/2''$ | | #4x50mm | | |
| | 2x | 2x | 4x | 1x | |

1

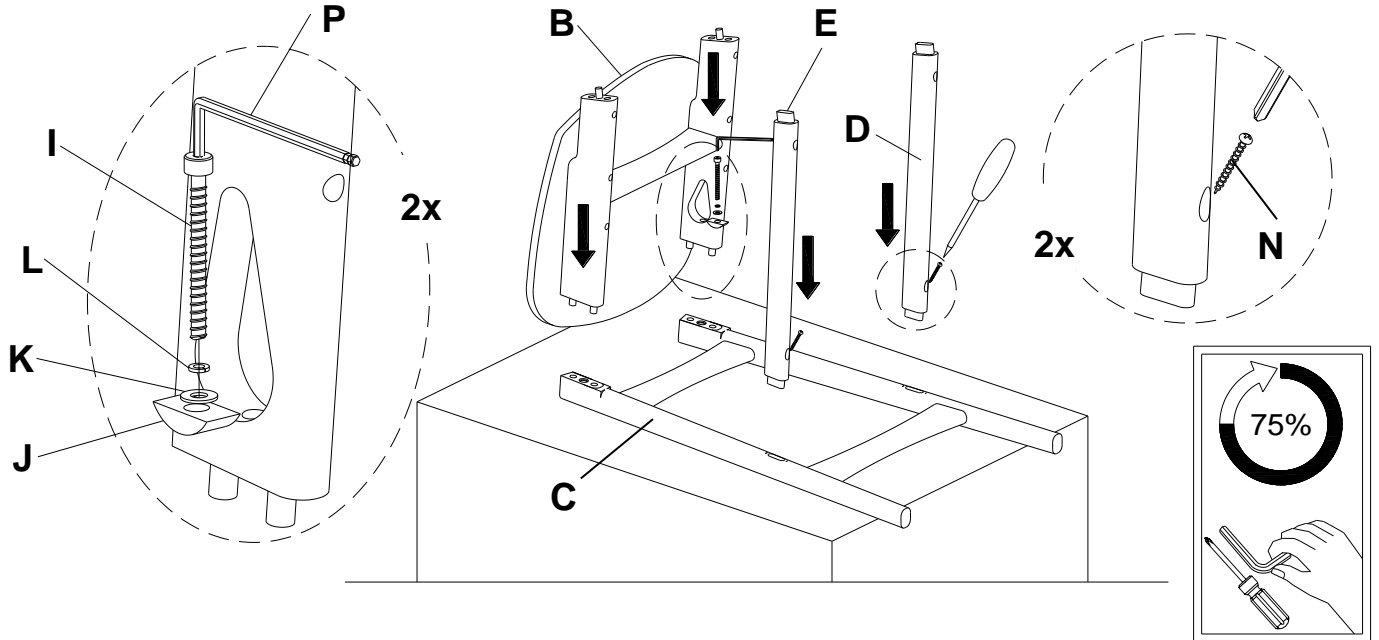

2

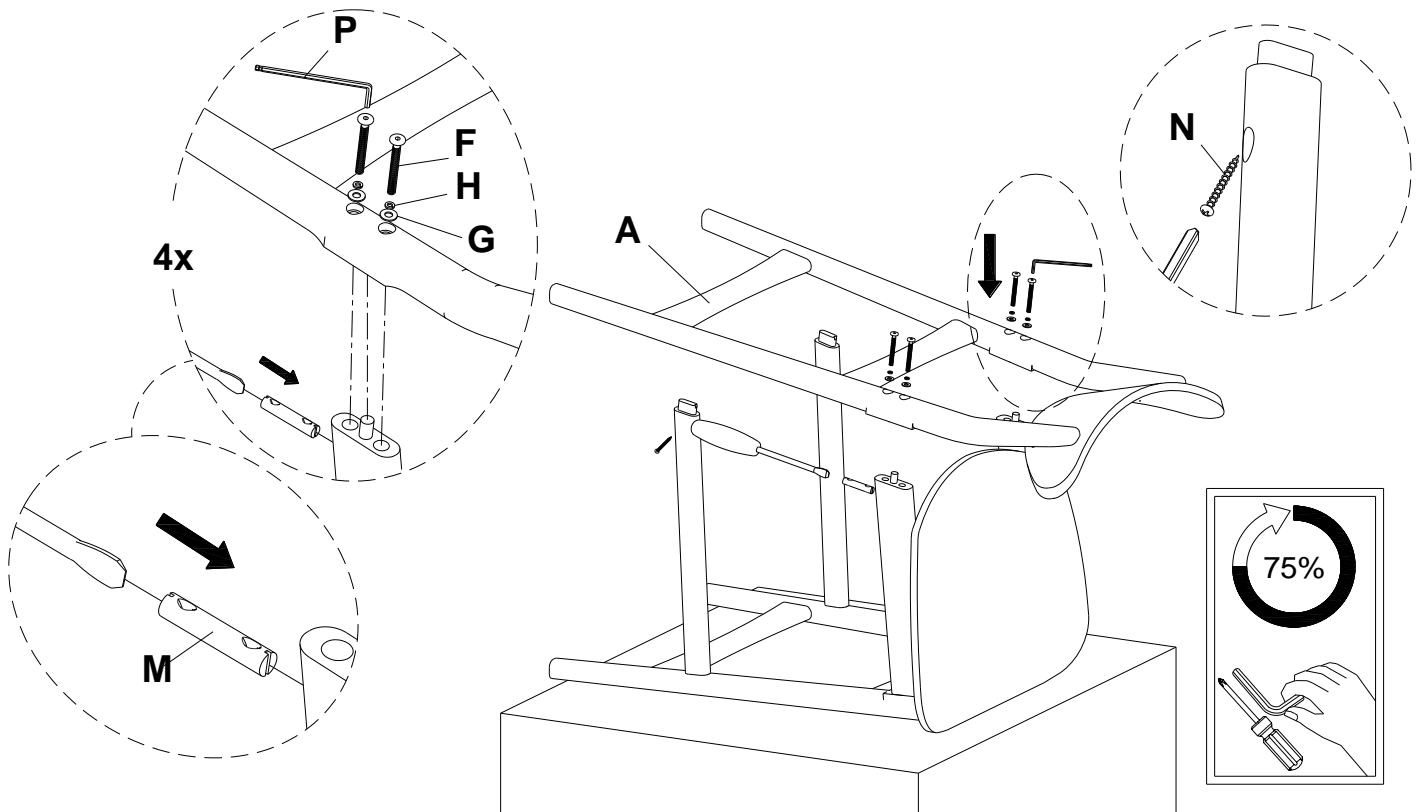

3

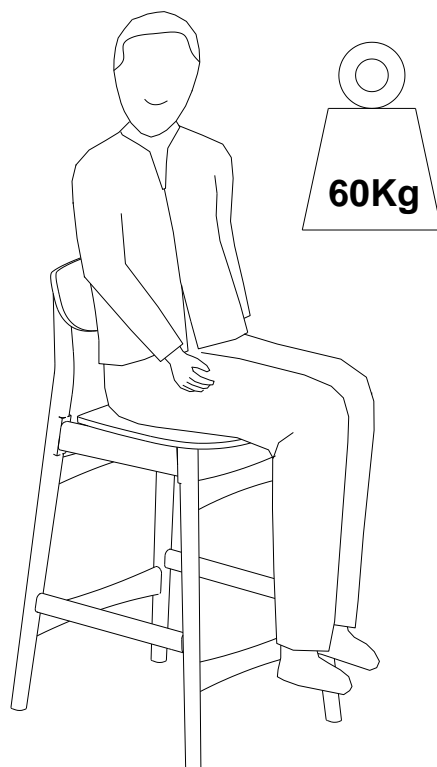

4

