



HANGING SHELF 24 INCH

ÉTAGÈRE D'ACCROCHAGE 24 PO

ESTANTE PARA COLGAR 24 PULGADAS

 **Warning! DO NOT MOUNT THIS ITEM ABOVE CRIBS, BEDS, or CHANGING TABLES**
Maximum total weight capacity for this product is 61 pounds (27.66 Kg),
Maximum loading capacity of the shelf (C) is 36 Pounds (16.33 Kg).
The maximum hanging capacity of the horizontal pole (B) is 25 pounds (11.33 kg)

 **Avertissement : NE PAS MONTER CET ARTICLE AU-DESSUS DES BERCEAUX, DES LITS OU DES TABLES À LANGER**
Ce produit supporte un poids maximum de 61 livres (27.66 kg).
Ce produit supporte un poids maximum de 36 livres (16,33 kg).
La capacité de suspension maximale du poteau horizontal (B) est de 25 livres (11,33 kg).

 **Advertencia: NO ENSAMBLAR ESTE ARTÍCULO SOBRE CUNAS, CAMAS o CAMBIADORES DE BEBÉ**
La capacidad total máxima de peso de este producto es 61 libras (27.66 kg).
La capacidad de carga máxima del estante (C) es 36 libras (16.33 kg).
La capacidad máxima para colgar del poste horizontal (B) es de 25 libras (11.33 kg).

ENGLISH

- Do not dispose of any packaging or contents of the shipping carton until assembly is completed to avoid accidentally discarding small parts or hardware.

FRANÇAIS

- Ne jetez rien des produits d'emballage et du contenu de la boîte jusqu'à ce que l'assemblage soit terminé, afin d'éviter de jeter par mégarde de petites pièces ou des morceaux.

ESPAÑOL

- Para evitar desechar accidentalmente las partes pequeñas o las piezas de ferretería, no tirar el embalaje o contenido de la caja hasta que el ensamblaje esté completo.

Care Instructions:

- Dust often using a clean, soft, dry and lint-free cloth.
- Blot spills and wipe with a clean, damp cloth immediately.
- We do not recommend the use of chemical cleansers, abrasives or furniture polish on our lacquered finish.
- Hardware may loosen over time. Periodically check to make sure all connections are tight. Re-tighten if necessary.

Instructions d'entretien :

- Épousseter régulièrement avec un chiffon propre, doux et non pelucheux.
- Éponger immédiatement les liquides renversés et essuyer à l'aide d'un chiffon propre et humide.
- L'utilisation de produits nettoyants chimiques, d'abrasifs ou d'encaustiques sur nos finitions laquées n'est pas recommandée.
- Le matériel de fixation peut se desserrer avec le temps. Vérifiez régulièrement afin de vous assurer que tous les raccords sont bien serrés. Resserrez-les au besoin.

Instrucciones de cuidado:

- Limpiar el polvo con un trapo limpio, suave, seco y libre de pelusas.
- Secar los derrames de inmediato y limpiar con un trapo limpio y húmedo.
- Recomendamos no usar limpiadores químicos, abrasivos o lustramuebles sobre el acabado barnizado.
- Las piezas de ferretería pueden aflojarse con el tiempo. Controlar periódicamente que estén bien ajustadas. Si es necesario, volver a ajustarlas.

22-July-2019

3/9

【Tools Required】

【Outils nécessaires】

【Herramientas necesarias】

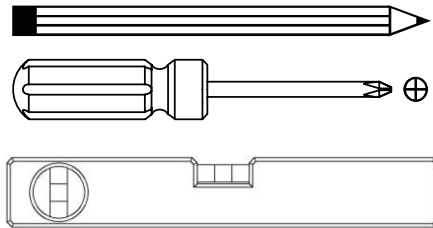
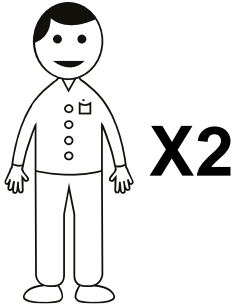

NOT INCLUDED / NON INCLUS / NO INCLUIDAS

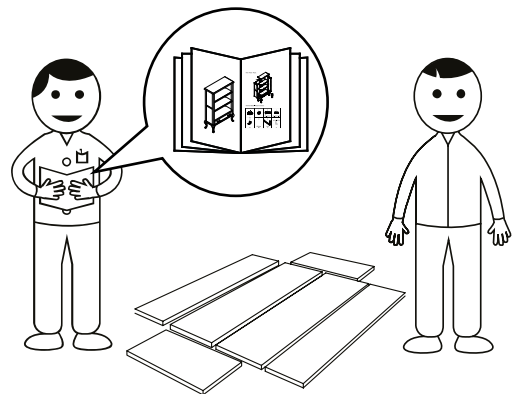
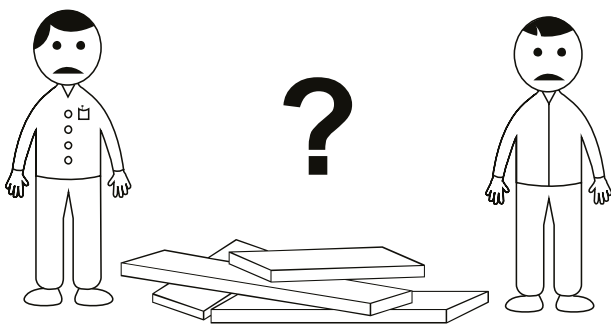

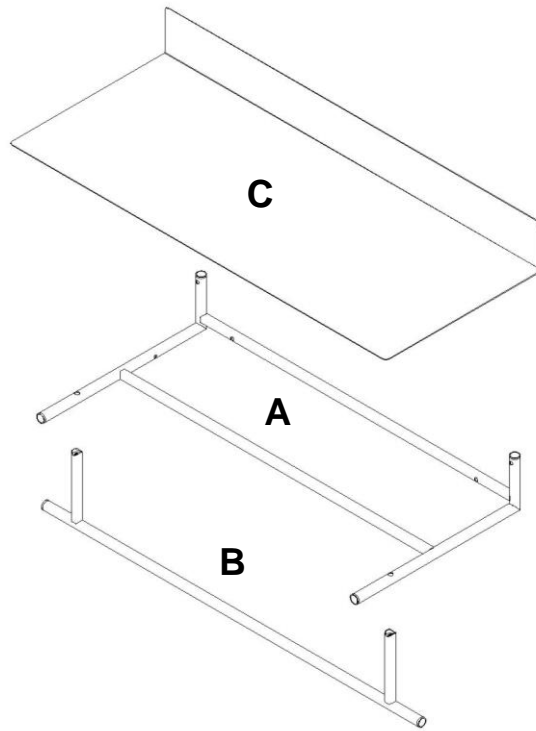

【 Parts Included 】
【 Pièces incluses 】
【 Piezas incluidas 】

D

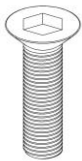

Socket head cap
screw(1/4"x1")

Vis de support à
capuchon (1/4 x 1 po)

Tornillo de cabeza del
portalámparas (1/4"x1")

X2

E

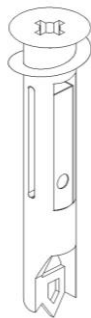

EZ-Toggle

Ancrage EZ

Anclaje EZ

X4

F



Mounting Screws
(5/32 x2")

Vis de montage
(5/32 x 2 po)

Tornillos de montaje
(5/32 x2")

X4

G



Hexagon socket button
head cap screw
(M4x6mm)

Vis à tête de bouton
hexagonale
(M4x6mm)

Tornillos de cabeza
hexagonal tipo botón
(M4x6mm)

X2

H

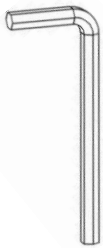

M4 Hex key

Clé hexagonale M4

Llave hexagonal M4

X1

I

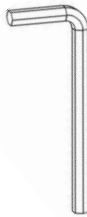

M2.5 Hex key

Clé hexagonale M2.5

M2.5 Llave hexagonal

X1

J

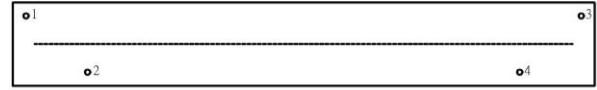

Templet

Gabarit

Plantilla

X1

1 Fixed position

Position fixe

Posición fija

J

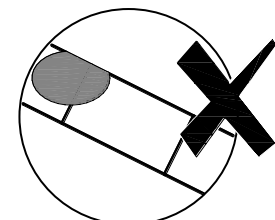
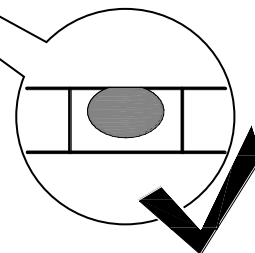
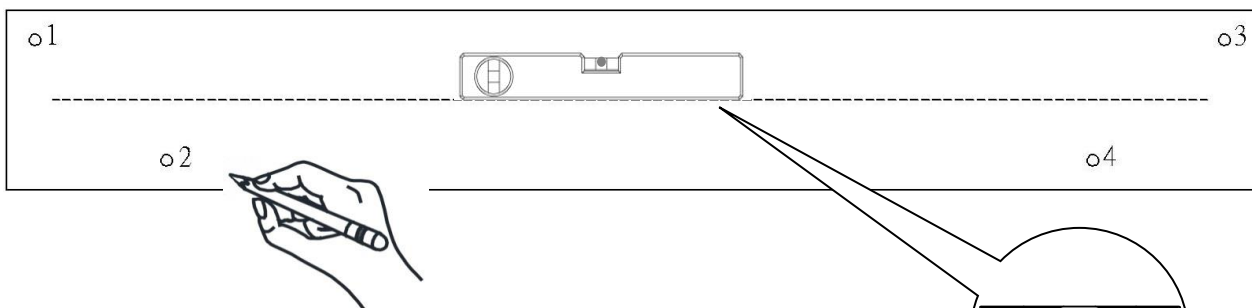

2 For non-stud mounting (EZ-Toggle required)

Montage sur cloison sèche (Ancrage EZ nécessaire)

Para montaje que no sea en vigas (se necesita un anclaje EZ)

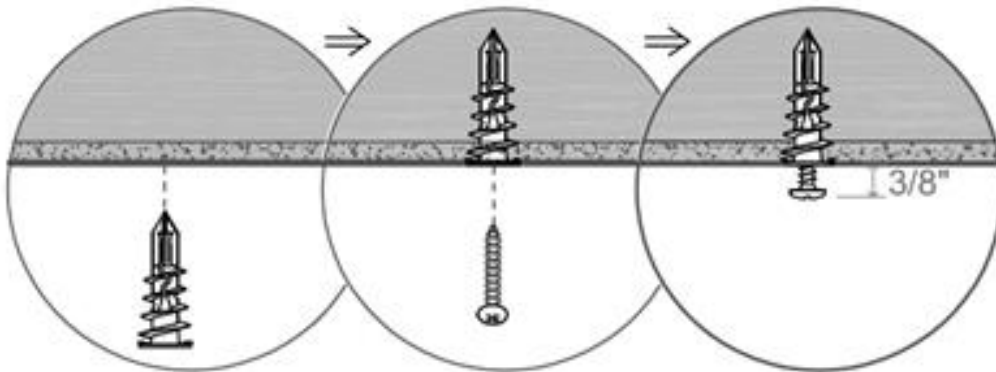

Tips/ Conseils/ Consejos:

The anchor is self-drillable. No pilot hole required.

L'ancrage se perce dans le mur. Aucun trou de guidage n'est requis. El anclaje es autoperforante. No se necesita un agujero piloto.

El anclaje es autoperforante. No se necesita un agujero piloto.

For stud mounting (EZ-Toggle not required)

Montage sur montant (Ancrage EZ non nécessaire)

Para montaje en vigas (no se necesita anclaje EZ)

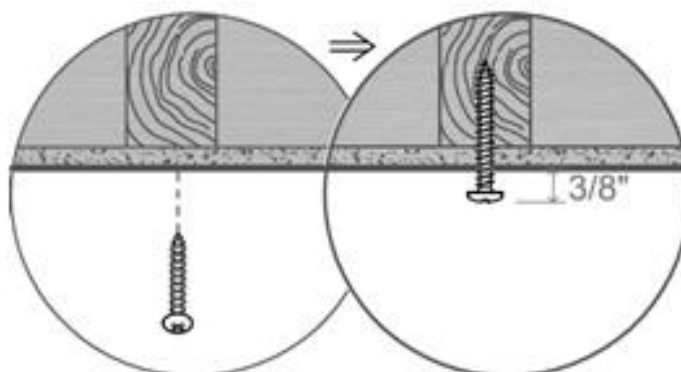

3 For non-stud mounting (EZ-Toggle required)

Montage sur cloison sèche (Ancrage EZ nécessaire)

Para montaje que no sea en vigas (se necesita un anclaje EZ)

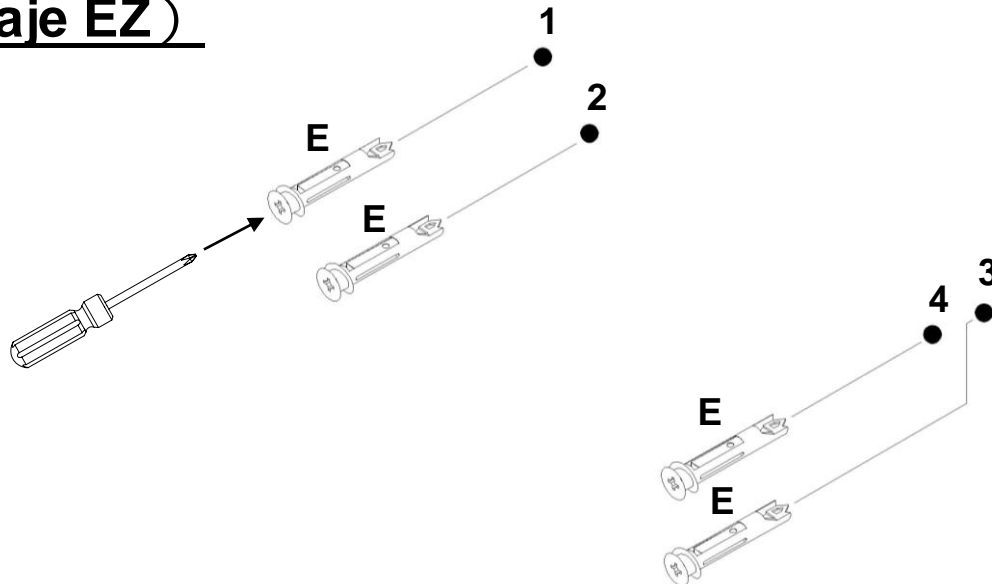

For stud mounting (EZ-Toggle not required)

Montage sur montant (Ancrage EZ non nécessaire)

Para montaje en vigas (no se necesita anclaje EZ)

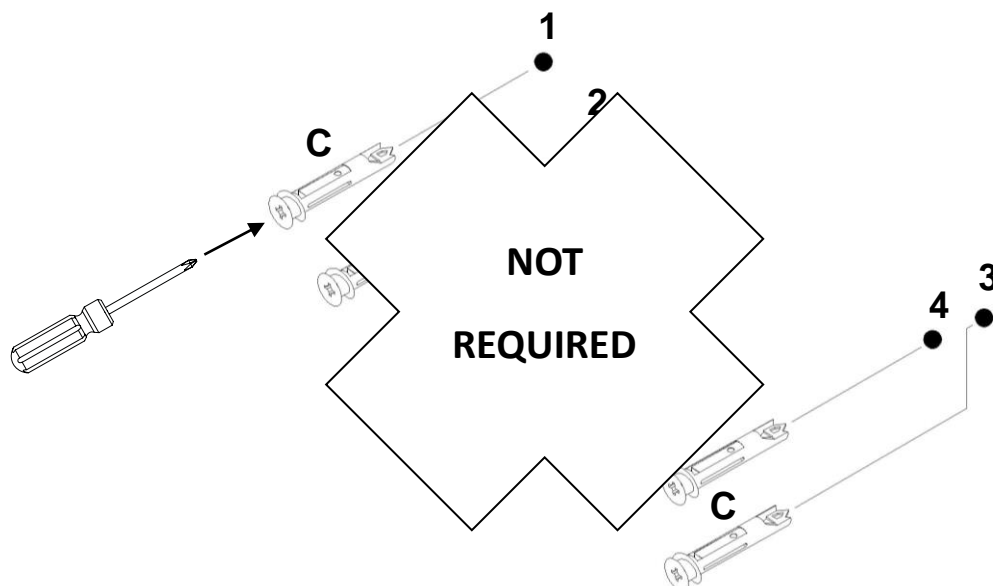

4 For non-stud mounting (EZ-Toggle required)

Montage sur cloison sèche (Ancrage EZ nécessaire)

Para montaje que no sea en vigas (se necesita un anclaje EZ)

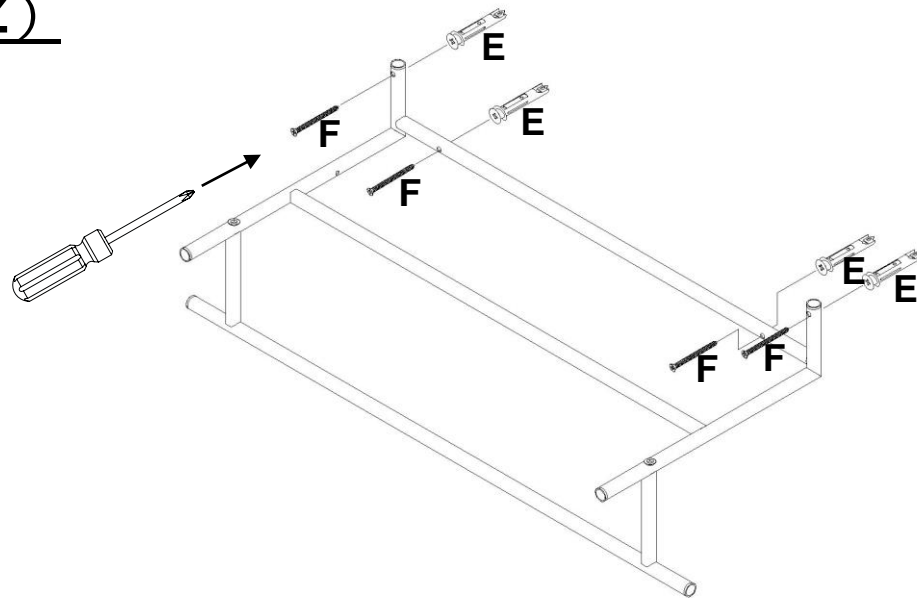

For stud mounting (EZ-Toggle not required)

Montage sur montant (Ancrage EZ non nécessaire)

Para montaje en vigas (no se necesita anclaje EZ)

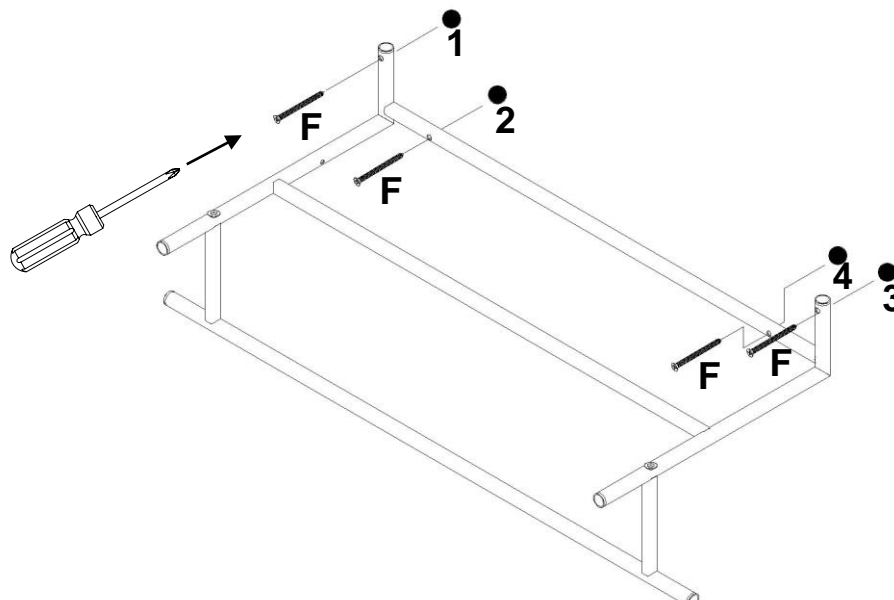

5

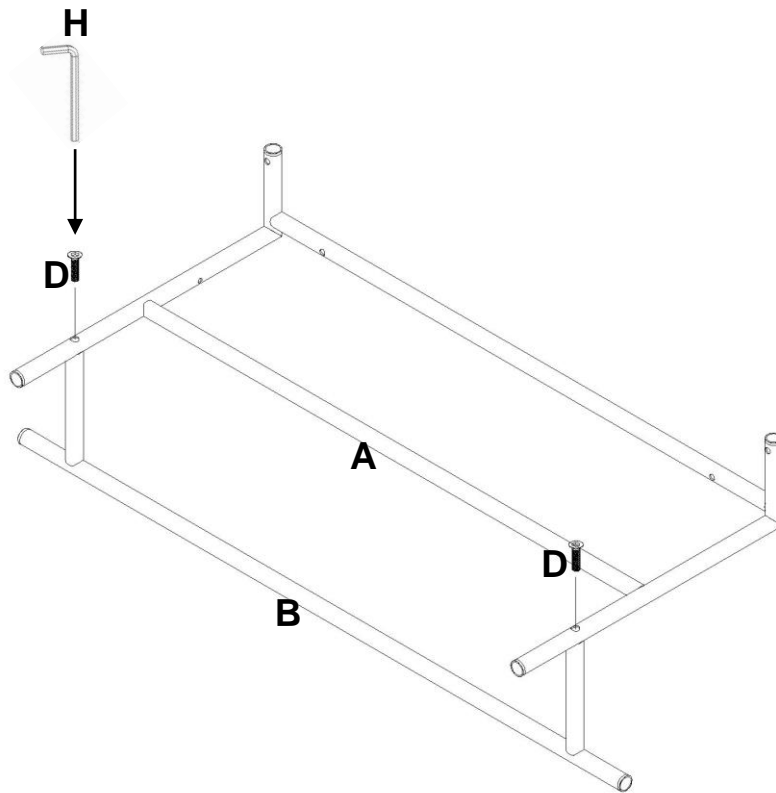

6

