

! Tools Required:







! Do not throw away packaging materials until assembly is complete.

! Assemble this item on a soft surface, such as: cardboard or carpet to protect finish.

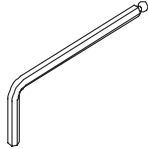
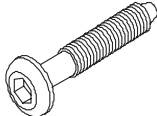
! Proper assembly of this item requires 2 people.

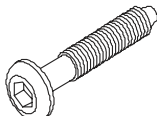
! Twin bedframe will include one set of slats as shown. Other bed sizes will include 2 sets of slats

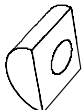
## Hardware

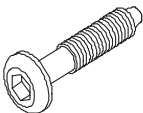
<p>A</p>  <p>allen key 1x</p>	<p>F</p>  <p>long bolt M6 x 40mm 10x (full, queen, king, cal. king)</p>
<p>B</p>  <p>spring washer 42x (full, queen, king, cal. king) 32x (twin)</p>	<p>G</p>  <p>long bolt M6 x 50mm 16x</p>
<p>C</p>  <p>flat washer 18x (full, queen, king, cal. king) 8x (twin)</p>	<p>H</p>  <p>dowel 8x</p>
<p>D</p>  <p>u-washer 8x</p>	<p>I</p>  <p>barrel nut 6x (full, queen, king, cal. king)</p>
<p>E</p>  <p>short bolt M6 x 20mm 16x</p>	

Parts

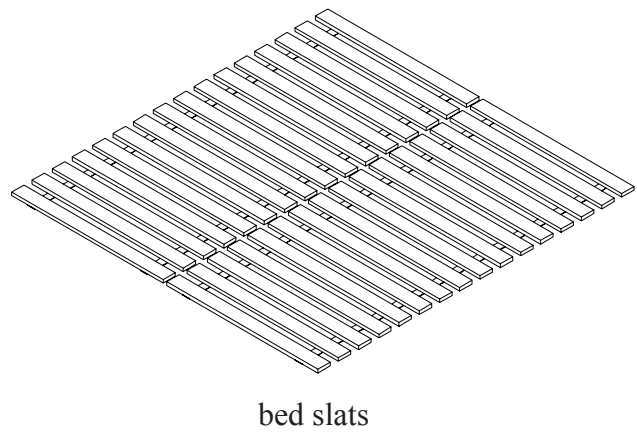
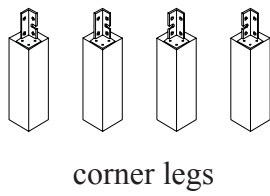
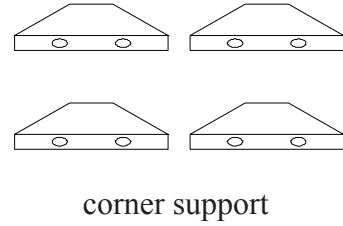
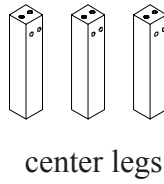
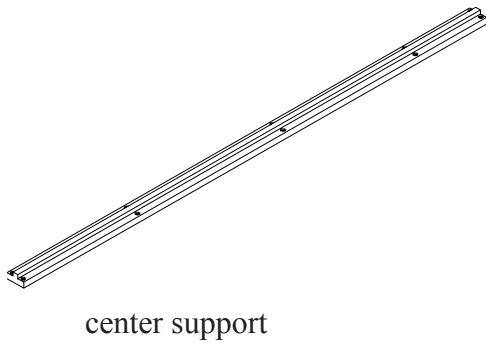
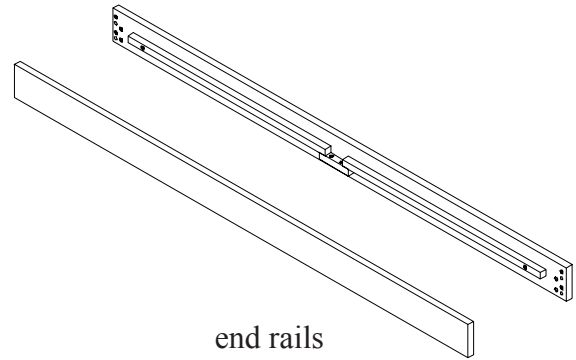
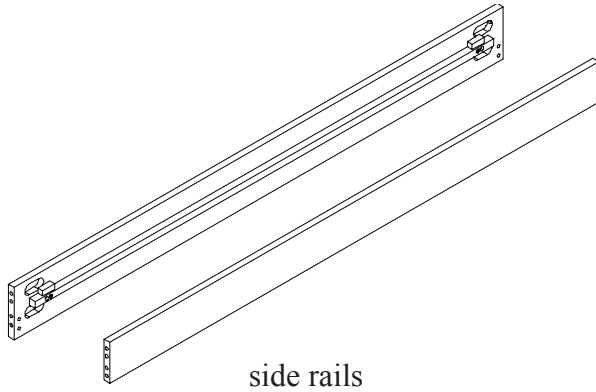

1. Fasten the side rails to the end rails by inserting dowel (H) in the pre-drilled holes and by inserting long bolts M6 x 50mm (G), spring washer (B), and u-washer (D) as shown. Tighten bolts using allen key (A).

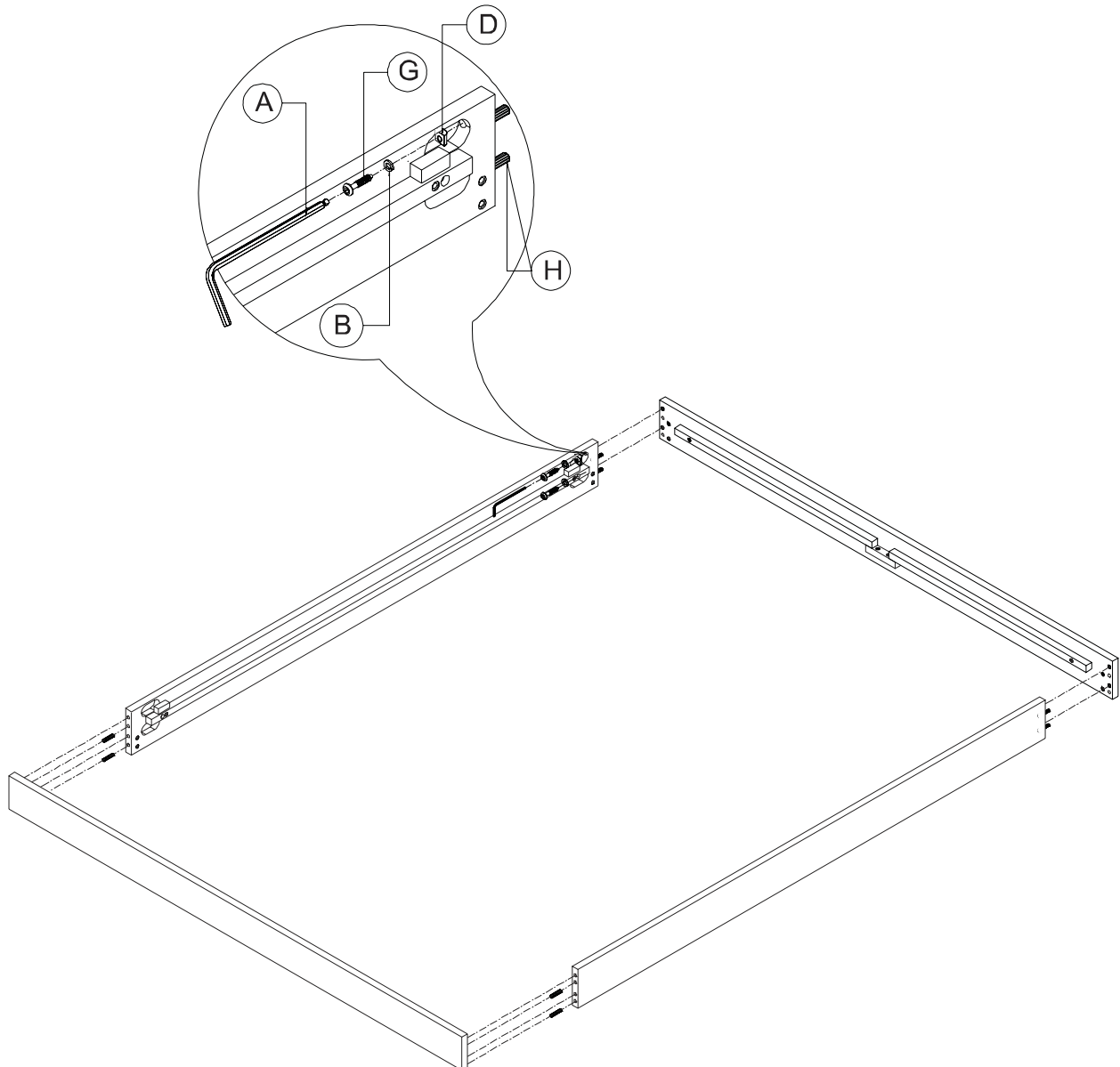

2. Fasten the legs to the bed frame using short bolts M6 x 20mm (E) and spring washers (B) as shown. Tighten bolts using allen key (A).

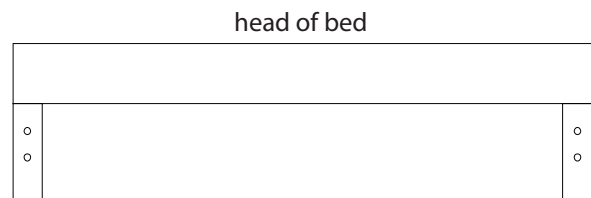
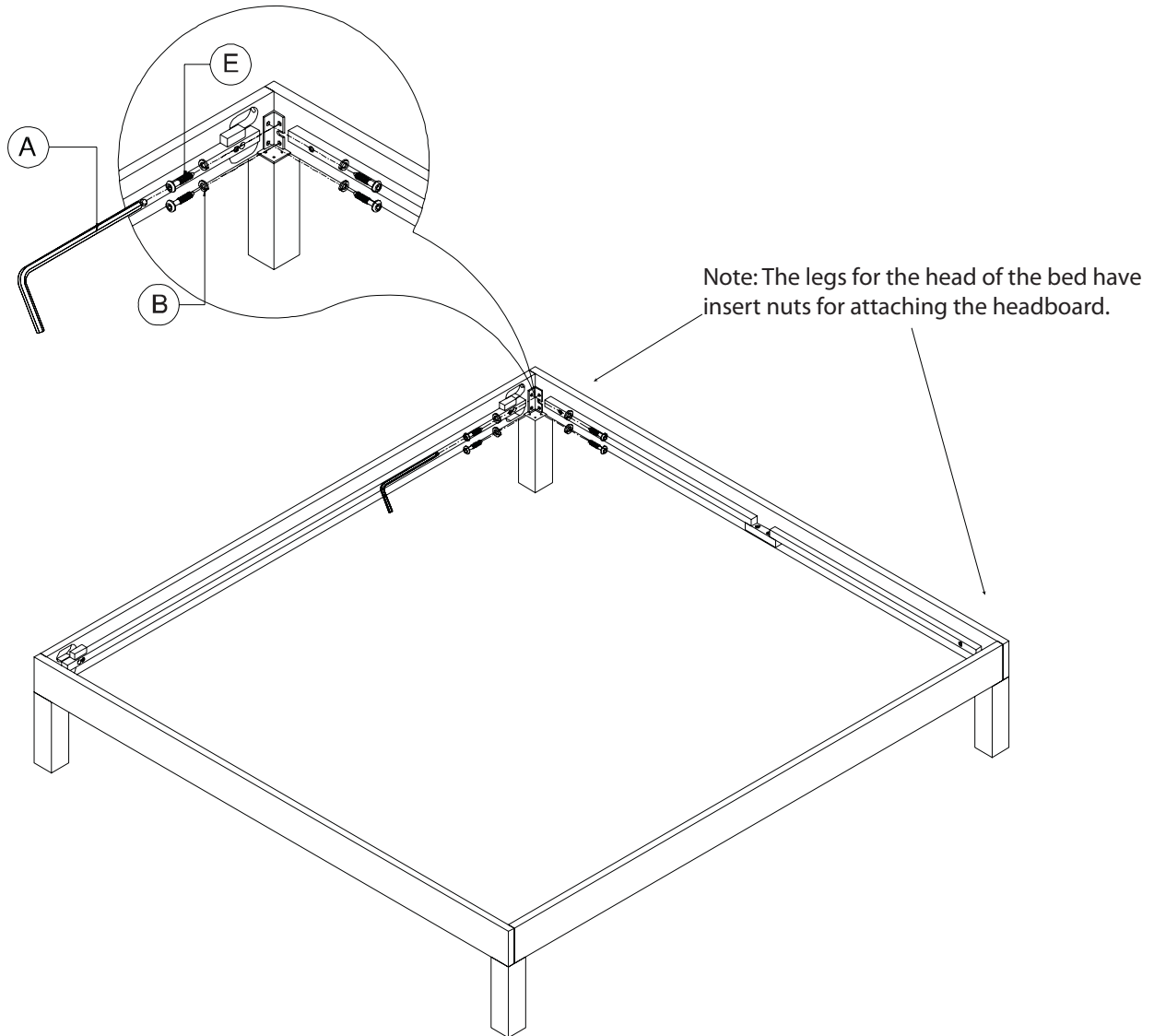

3. Fasten the corner supports to the bed frame using long bolts M6 x 50mm (G), spring washer (B), and flat washer (C) as shown. Tighten bolts using allen key (A).

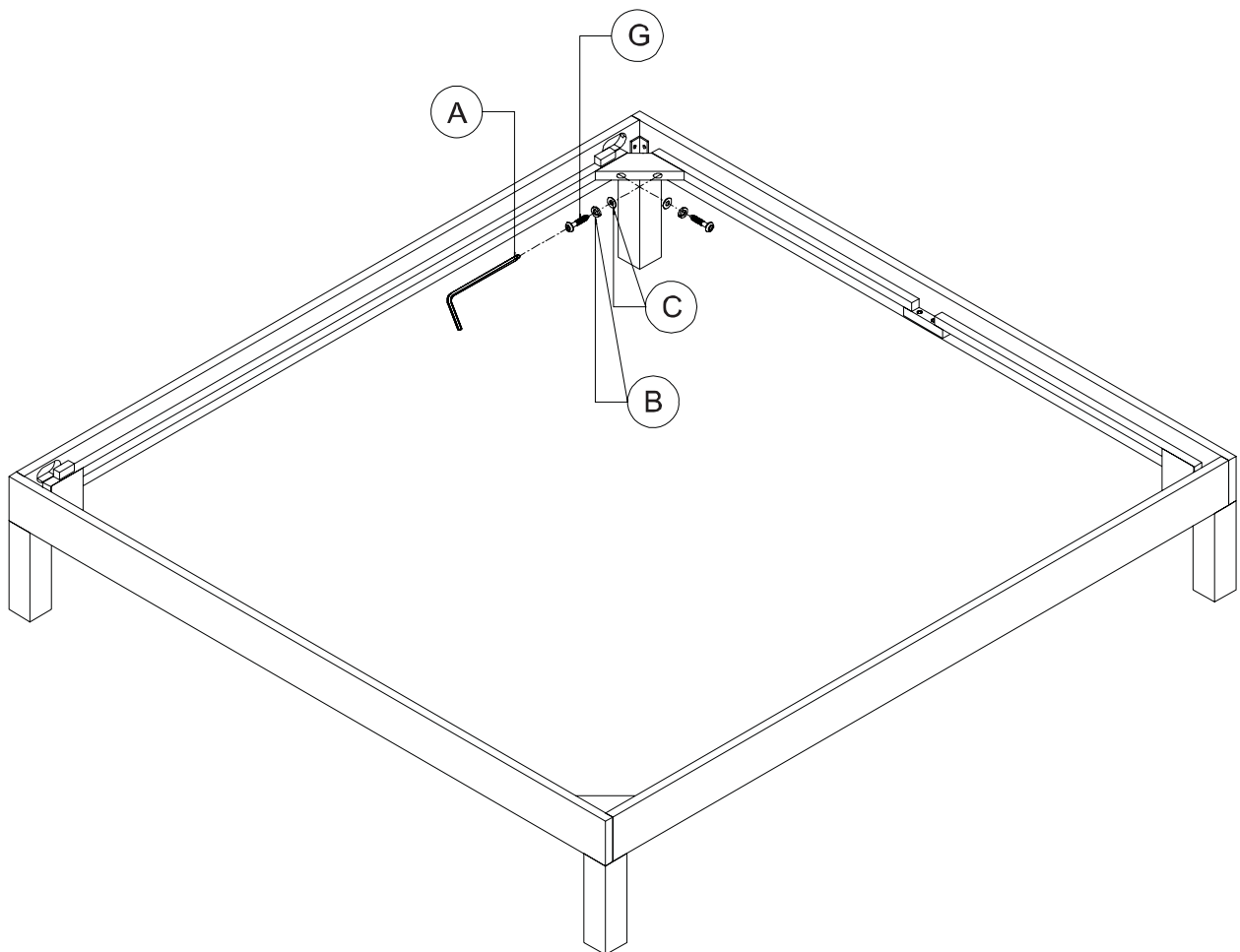

NOTE: For the twin bedframe skip ahead to step 7.

4. Insert barrel nuts (I) into the pre-drilled holes of the center legs. Attach the center support to the center legs by using long bolts M6 x 40mm (F), spring washers (B), and flat washers (C). Tighten bolts with allen key (A).

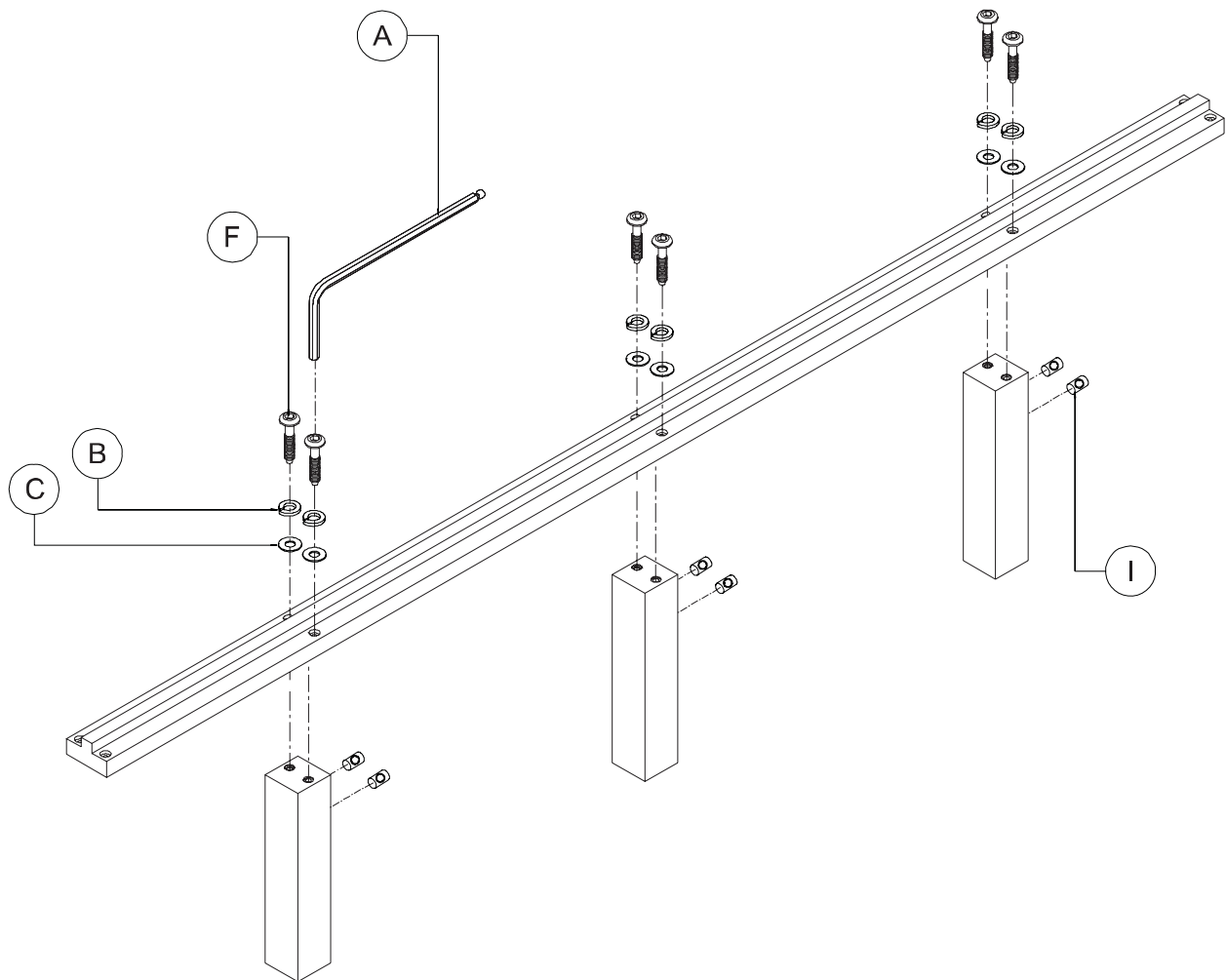

5. Attach the center support to the end rails by using long bolts M6 x 40mm (F), spring washers (B), and flat washers (C) as shown. Tighten using allen key (A).
6. Adjust the levelers on the center legs so that they are in firm contact with the floor.

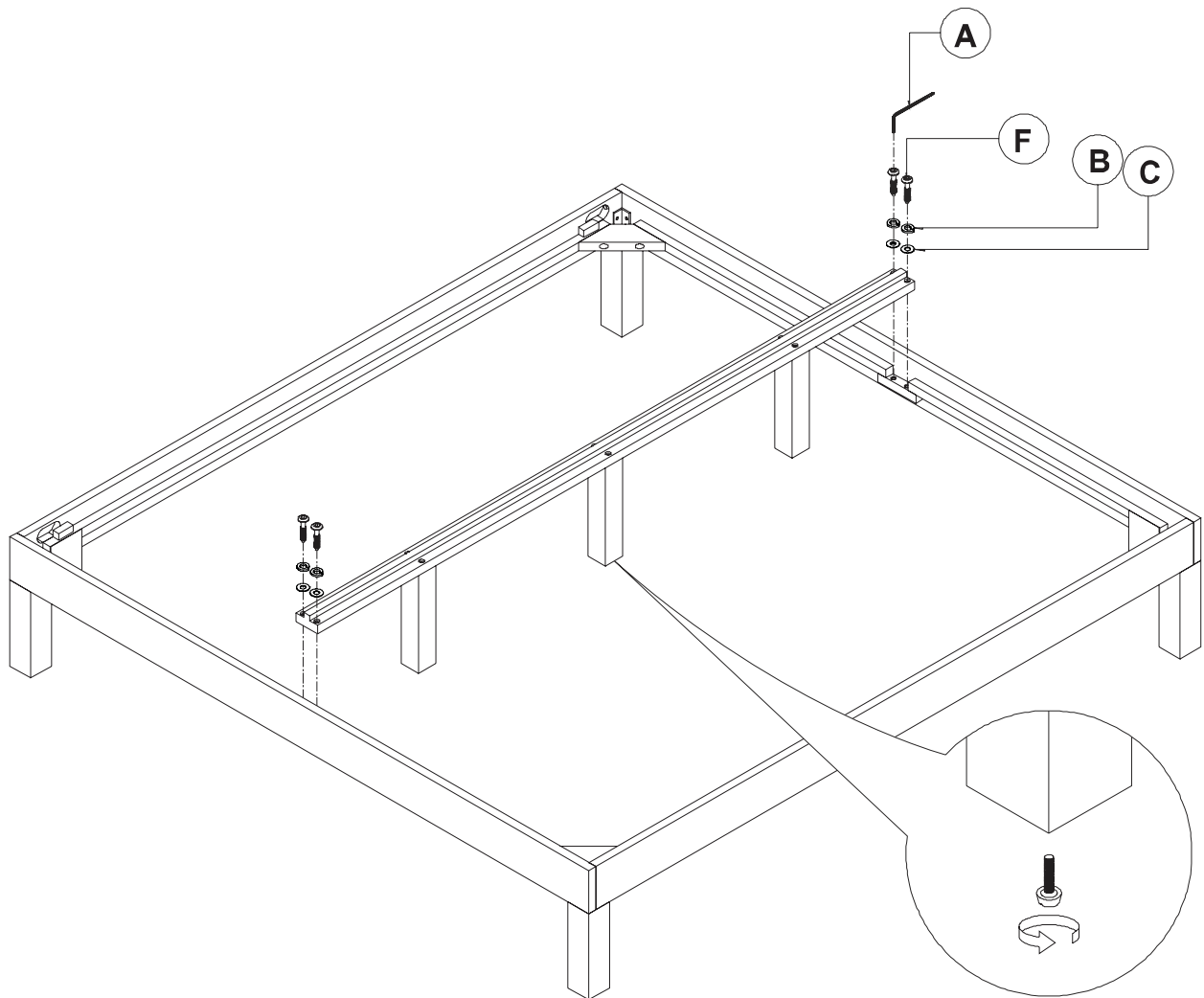

NOTE: For full, queen or king size frames, two sets of slats are used as shown. For twin size one set of slats is used.

7. Carefully set slats into frame as shown.

