

## MID CENTURY MEDICINE CABINET ARMOIRE À PHARMACIE MID CENTURY BOTIQUÍN MID CENTURY

Maximum load is 69 pounds (31.3 Kg), (23 pounds (10.4 Kg) maximum per horizontal surface).

La charge maximale est de (69 livres (31.3 kg), (23 livres (10.4 kg) maximum par surface horizontale)

Carga máxima 69 libras (31.3 Kg), (23 libras (10.4 Kg) máximo por superficie horizontal).

---

## ENGLISH

- Do not dispose of any packaging or contents of the shipping carton until assembly is completed to avoid accidentally discarding small parts or hardware.

## FRANÇAIS

- Ne jetez rien des produits d'emballage et du contenu de la boîte jusqu'à ce que l'assemblage soit terminé, afin d'éviter de jeter par mégarde de petites pièces ou des morceaux.

## ESPAÑOL

Para evitar desechar accidentalmente las partes pequeñas o las piezas de ferretería, no tirar el embalaje o contenido de la caja hasta que el ensamblaje esté completo.

---

### Care Instructions:

- Dust often using a clean, soft, dry and lint-free cloth.
- Blot spills and wipe with a clean, damp cloth immediately.
- We do not recommend the use of chemical cleansers, abrasives or furniture polish on our lacquered finish.
- Hardware may loosen over time. Periodically check to make sure all connections are tight. Re-tighten if necessary.

### Instructions d'entretien :

- Éponseter régulièrement avec un chiffon propre, doux et non pelucheux.
- Éponger immédiatement les liquides renversés et essuyer à l'aide d'un chiffon propre et humide.
- L'utilisation de produits nettoyants chimiques, d'abrasifs ou d'encaustiques sur nos finitions laquées n'est pas recommandée.
- Le matériel de fixation peut se desserrer avec le temps. Vérifiez régulièrement afin de vous assurer que tous les raccords sont bien serrés. Resserrez-les au besoin.

### Instrucciones de cuidado:

- Limpiar el polvo con un trapo limpio, suave, seco y libre de pelusas.
- Secar los derrames de inmediato y limpiar con un trapo limpio y húmedo.
- Recomendamos no usar limpiadores químicos, abrasivos o lustramuebles sobre el acabado barnizado.
- Las piezas de ferretería pueden aflojarse con el tiempo. Controlar periódicamente que estén bien ajustadas. Si es necesario, volver a ajustarlas.

“WARNING! DO NOT MOUNT THIS ITEM ABOVE CRIBS, BEDS, or CHANGING TABLES.”  
ATTENTION! NE PAS MONTER CET ARTICLE OU-DESSUS du berceaux, lits, ou tables à langer.  
ADVERTENCIA! NO MONTE ESTE ARTÍCULO ARRIBA cunas, camas, o mesas para cambiar pañales.

# Williams -Sonoma Inc.

Assembly Instructions  
Instructions d'assemblage  
Instrucciones de Ensamblaje

Pottery Barn – Pottery Barn Teen – Pottery Barn Kids – Williams Sonoma Home – West Elm – Rejuvenation – Mark and Graham

27-APR-2020

3/8

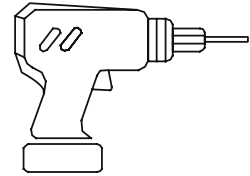
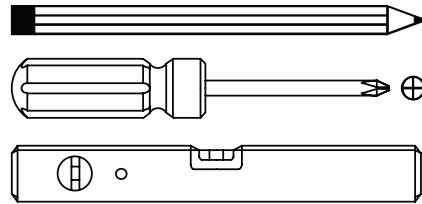
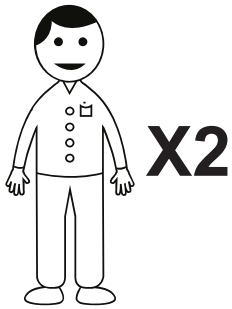

NOT INCLUDED / NON INCLUS / NO INCLUIDAS

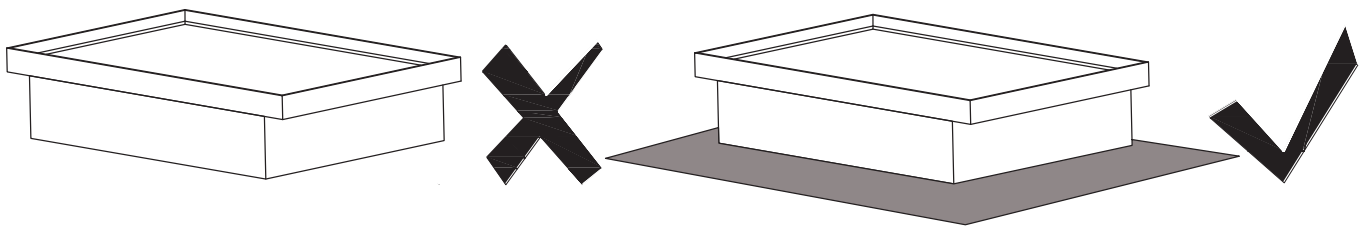
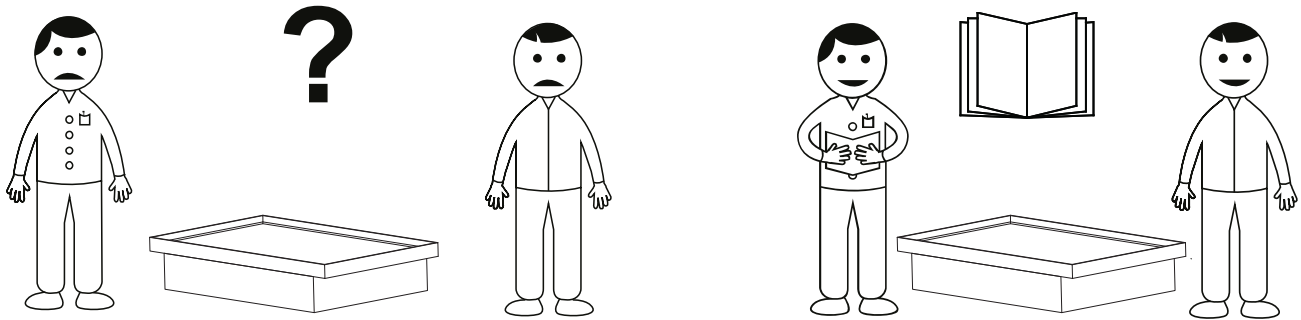

**Note:** This hanging system is meant for dry wall mounting only. If walls are concrete, brick or plaster, or use steel studs please consult a licensed contractor and your local hardware store for assistance. For safety and ease of mounting, installation is recommended using two people.

**Remarque :** Ce système de suspension est destiné uniquement à un montage sèche/montant seulement. Si les murs sont en béton, brique ou plâtre, ou lors de l'utilisation des montants en acier, consulter un entrepreneur agréé et la quincaillerie locale pour obtenir de l'aide. Pour des raisons de sécurité et pour faciliter le montage, il est recommandé que deux personnes participent à cette installation.

**Nota:** Este sistema de colgado es solamente para muro en seco. Si las paredes están hechas de concreto, ladrillos o yeso, consulte a un contratista con licencia y a su ferretería local para que lo ayuden. Para mayor seguridad y facilidad de montaje, se recomienda que dos personas realicen la instalación.

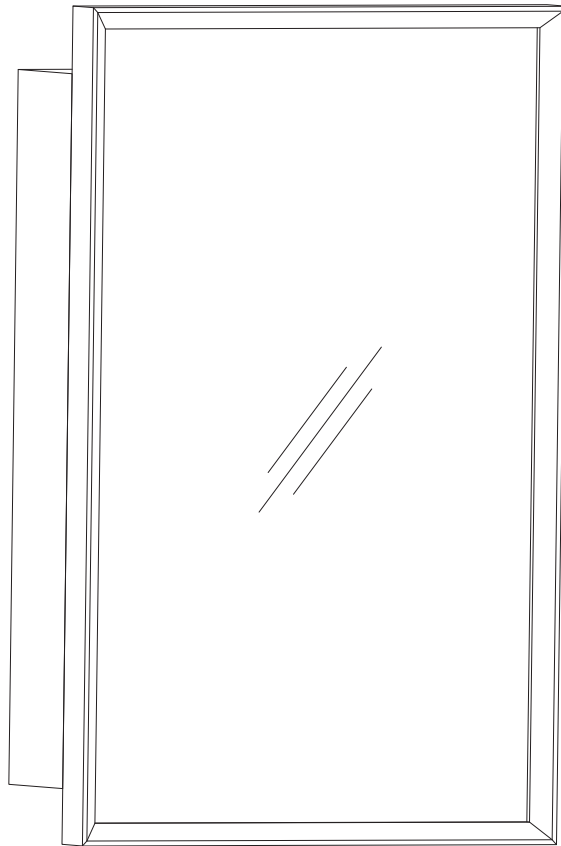

(A)



Dia. 10x4x57 mm  
2 x

(B)

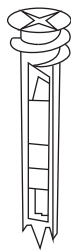

Dia. 15.5x63.5 mm  
2 x

(C)

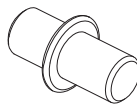

8 x

(D)

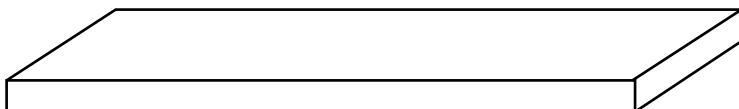

2 x

1

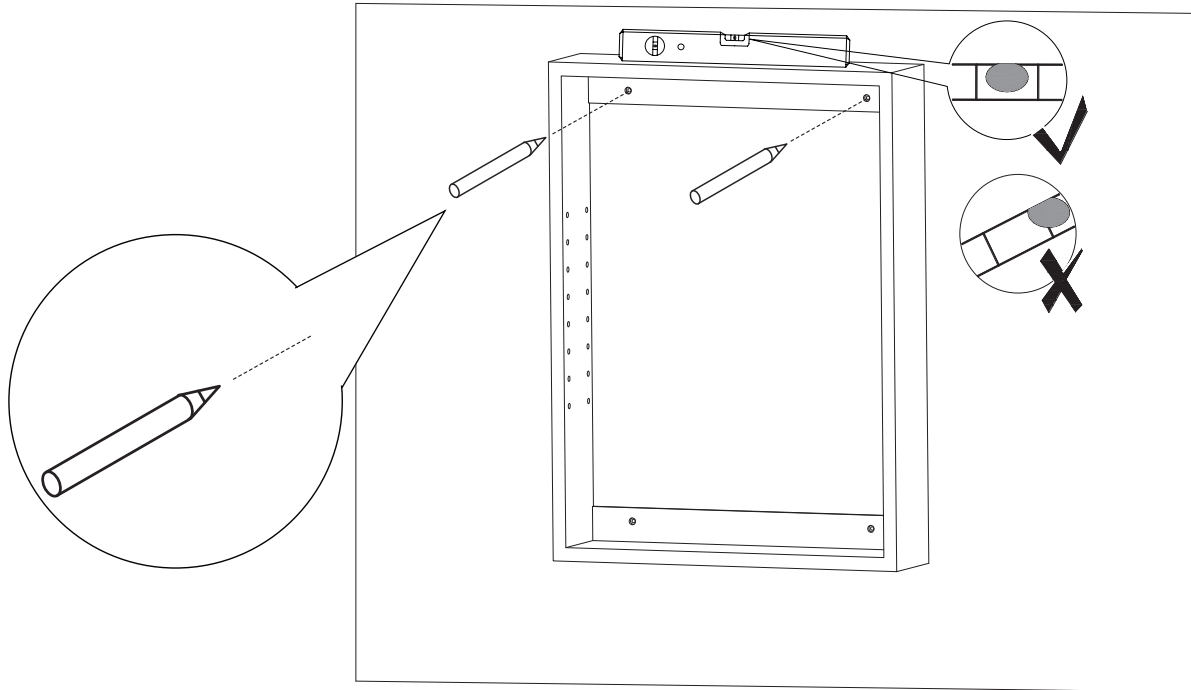

2

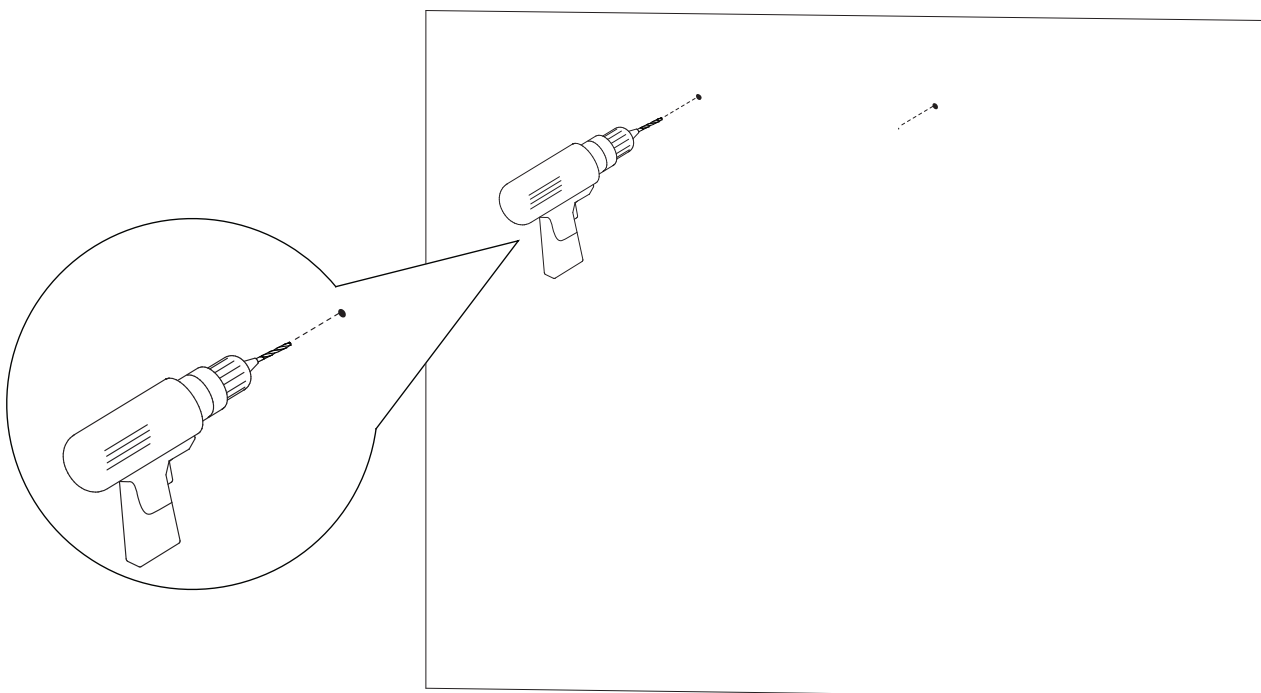

### 3

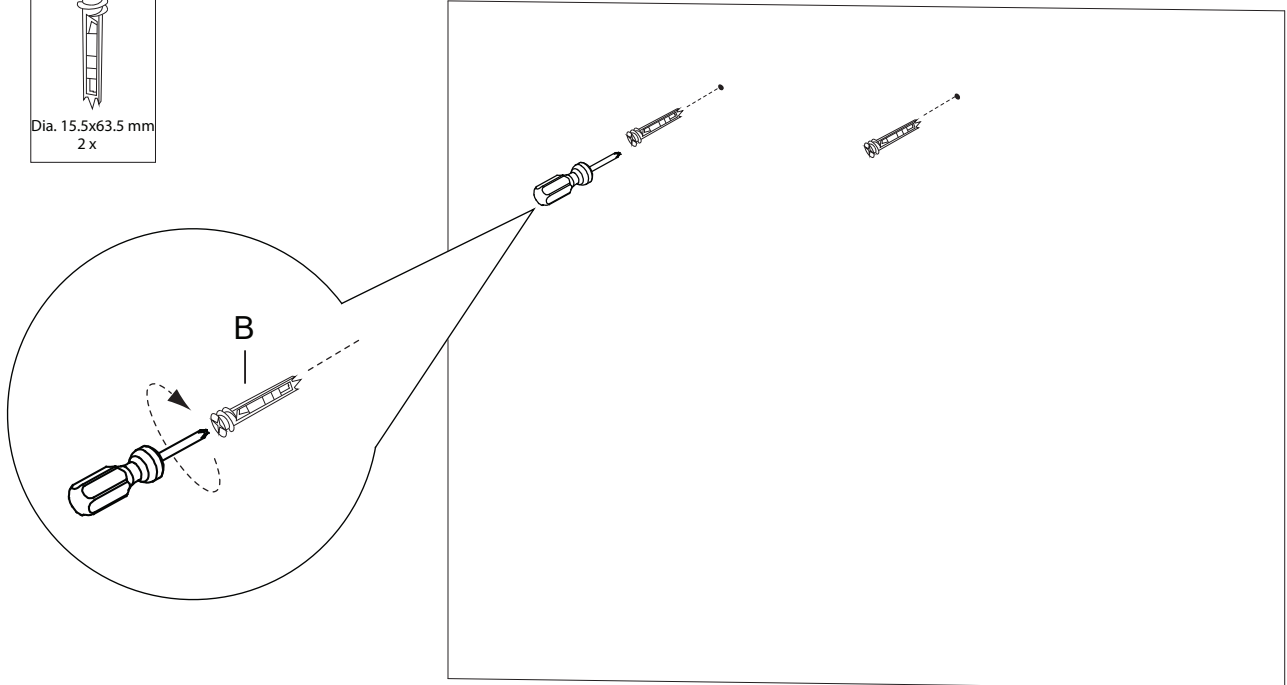
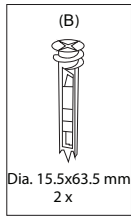

### 4

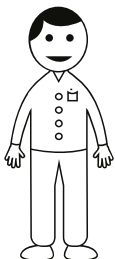
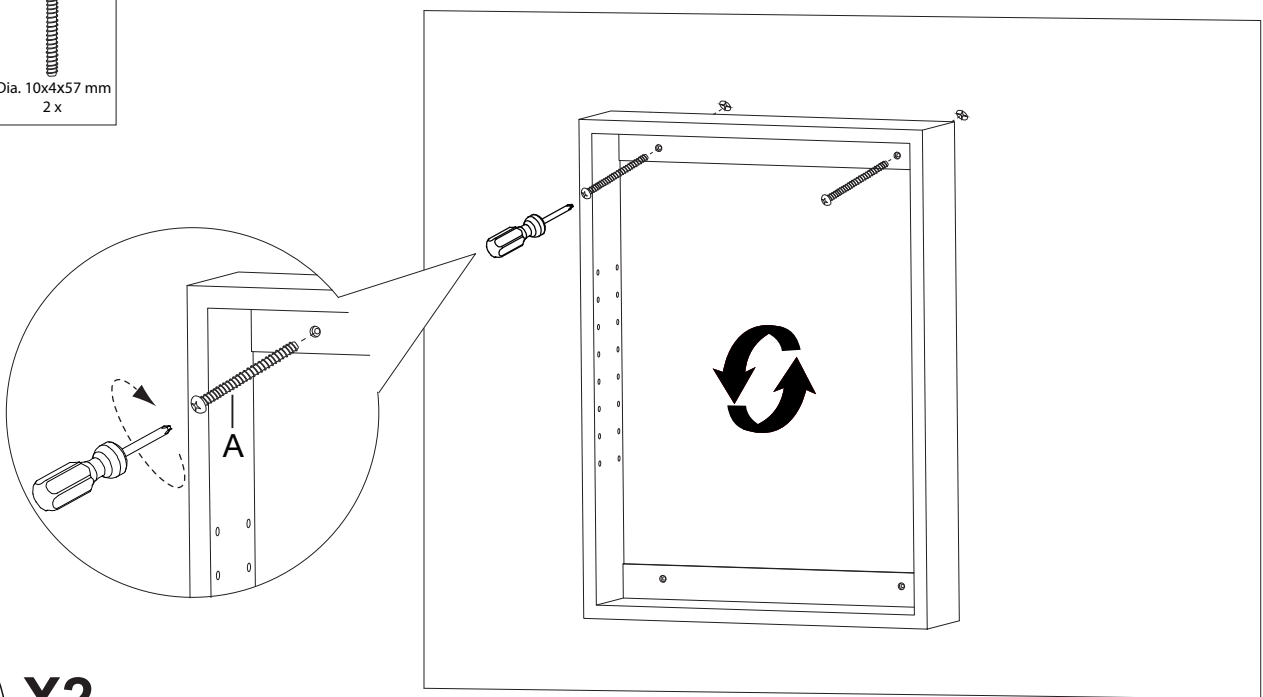
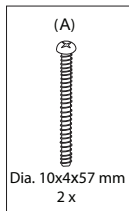

**X2**

## 5

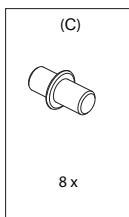
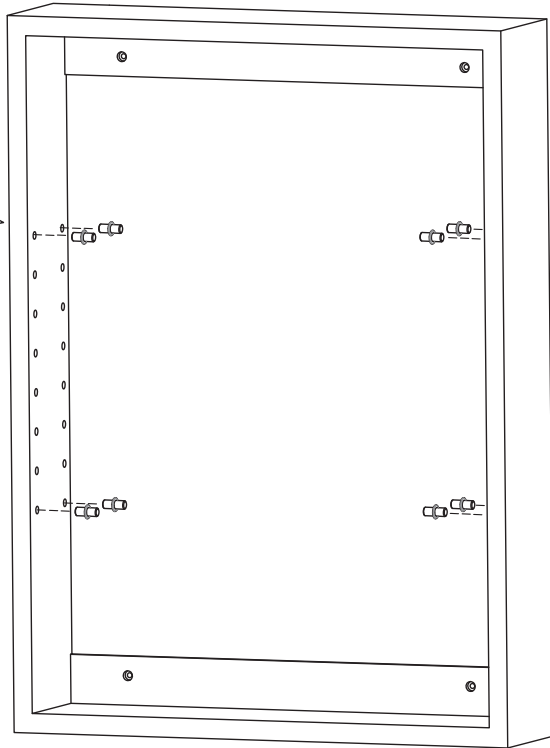
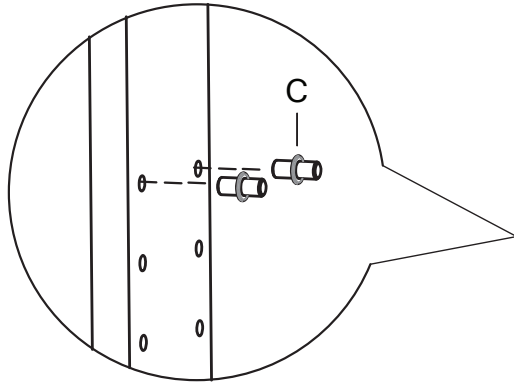

## 6

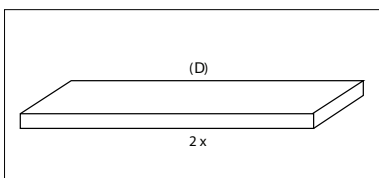
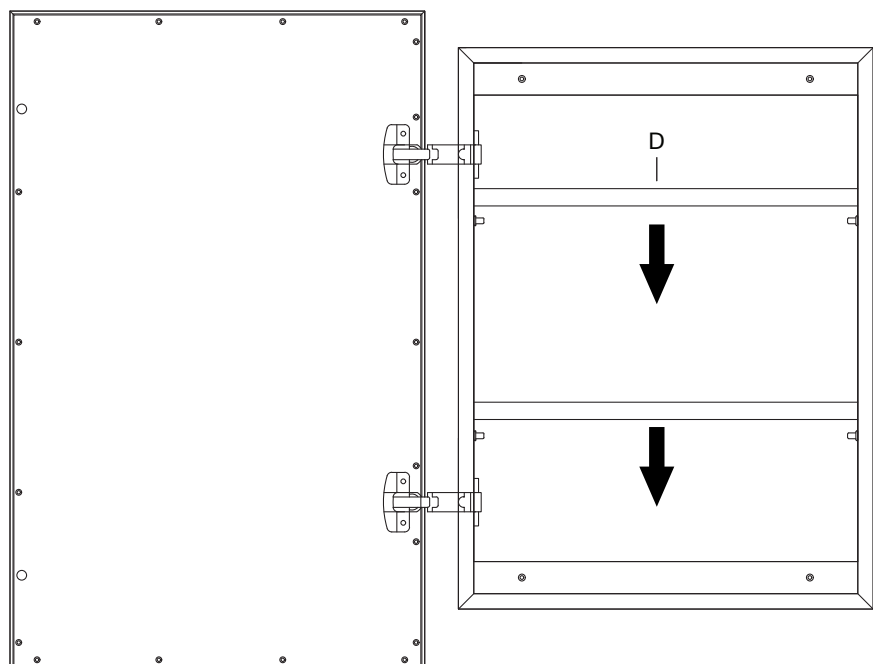
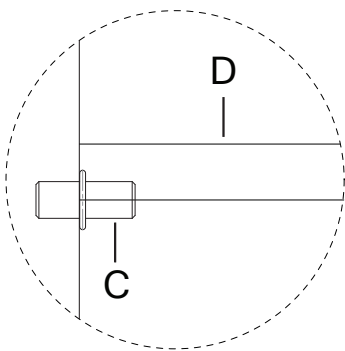

## 7

