



## Beadboard Bookcase

### Pre-assembly:

- Please read all instructions before beginning assembly.
- Two-person assembly is recommended.
- Save all packing materials until assembly is complete to avoid accidentally discarding smaller parts or hardware.

### Parts included:

A - (3) Adjustable shelves

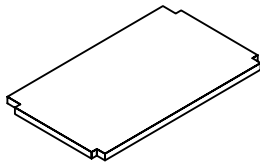

### Hardware Included:

B - (16) Shelf support pegs (5 x 13 x 16 x 1.5mm)  
(4 for use with each of 3 adjustable shelves)

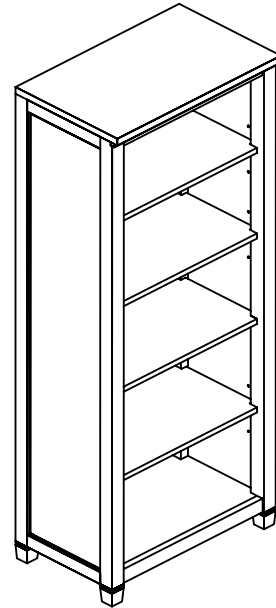
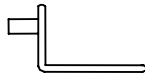

### Tools Required:

Phillip Screwdriver (not included)

### Assembly:

1. On a soft, scratch-free surface, such as a carpet or rug, remove the bookcase from box.
2. Determine the desired height for shelf using the corresponding peg holes in the bookcase interior.
3. Insert the shelf support pegs (B) into the pre-drilled holes until fully secure. Place shelf (A) onto the support pegs making sure the shelf is stable. See illustration.
4. Adjust the recessed levelers located at the base of each leg to keep the bookcase level.
5. Hardware should be checked periodically for tightness.

### Care Instructions:

- Avoid direct sunlight and excessive temperatures.
- Dust often using a clean, soft, dry and lint-free cloth.
- Slightly moisten cloth with water. A damp cloth holds dust and prevents scratching.
- Waxing is not recommended on lacquered finish.

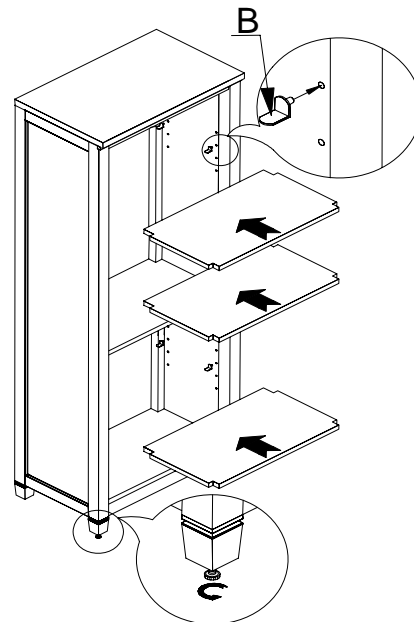

## Furniture Tipping Restraint

Young children may be injured by tipping furniture. The use of a tipping restraint is highly recommended.

When properly installed, this restraint could provide protection against the unexpected tipping of furniture due to small tremors, bumping or climbing. We recommend mounting this restraint to a wall stud.

**WARNING:** This product is only a deterrent. It is not a substitute for proper adult supervision.

### Hardware Included:

A - (2) Brackets

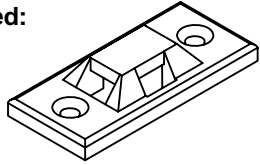

B - (2) Long screws (6 x 32)

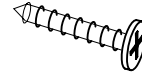

C - (2) Short screws (6 x 20)



D - (1) Nylon strap

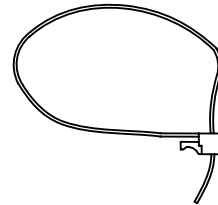

### Installation Instructions:

1. Locate a wall stud behind your furniture. Position a Bracket (A) on the stud approximately 1" below the top of the furniture. Mark and drill pilot hole into the center of the stud with a 3/32" drill bit. Attach a Bracket (A) to the stud with the Long Screws (B) provided.
2. On the back of the furniture, the second Bracket (A) will need to be attached to the furniture frame at the top. To do this, temporarily move the furniture into its final position and mark the location of the wall's Bracket (A) on the furniture frame with a pencil.
3. Move the furniture away from the wall and place a Bracket (A) on the mark. Using the marks from the previous step as a guide, drill holes for screws with a 3/32" drill bit. Attach the bracket to the furniture with the Short Screws (C) provided.
4. Move the furniture into its final position, taking care to line up the wall bracket with the furniture bracket. Thread the Nylon Strap (D) through the Bracket and cinch as shown in the illustration. Tighten strap until snug. Do not overtighten.

