

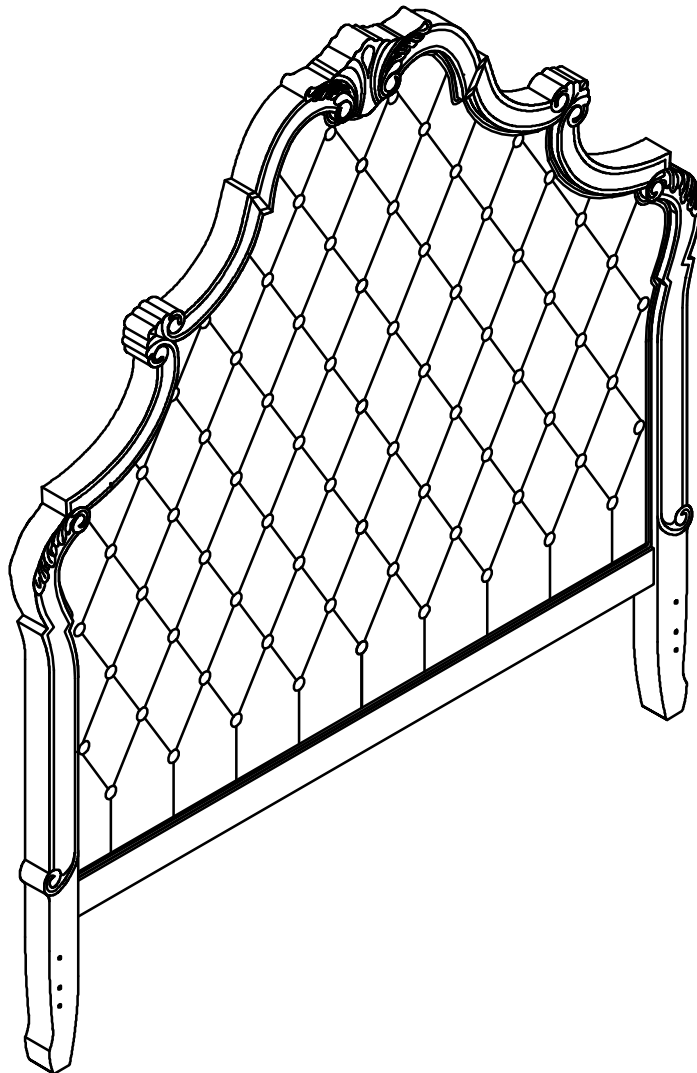

PARISIAN HEADBOARD

ASSEMBLY INSTRUCTIONS



Important Safety Instructions:

- Please read all instructions carefully before assembling this product.
- For your safety, assembly by two or more adults is strongly recommended.
- Keep instructions for future use.
- Use only vendor-supplied hardware to assemble. Using unauthorized hardware could jeopardize the structural integrity of the item.

Pre-assembly:

- Remove all parts/hardware from the box and place them on a carpeted or scratch-free work surface, as this will avoid damaging parts during assembly. The shipping box provides an ideal work surface.
- To avoid accidentally discarding small parts or hardware, do not dispose of any packaging or contents of the shipping carton until assembly is complete.
- Use the parts and hardware lists below to identify and separate each of the pieces included.
- The illustrations provided allow for easier assembly when used in conjunction with the assembly instructions.
- The use of power tools to aid in assembly is not recommended. Power tools can damage hardware and split wood.



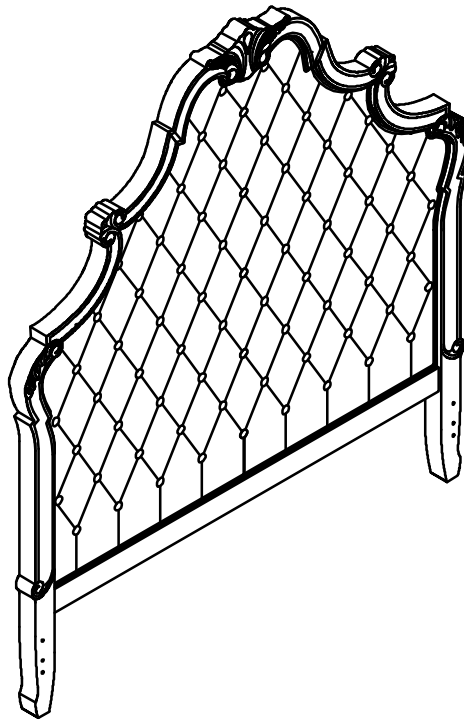

Parts Included:

(A) Headboard



A

Hardware Included:

<p>(B) Bolt ø1/4" * 2 1/4" - 6pcs</p> 	<p>(C) Spring washer ø1/4" - 6pcs</p> 	<p>(D) Flat washer ø1/4" - 6pcs</p> 	<p>(E) Allen key - 2x</p> 	<p>(F) Sleeve nut ø1/4" * 3/4" - 6pcs</p> 
---	---	---	--	---

Required for Assembly:

Pre-assembled bed frame (not included)

Assembly Instruction Steps:

1. Position the Headboard (A) upright, as shown in the illustration below.
2. Insert the sleeve nut (F) to the holes on the back of headboard post.
3. Align the slots of the faceplate with the pre-drilled holes of the headboard (A) as seen in Fig.1 below .
4. Insert the bolts (B) through the spring washers (C), flat washers (D), faceplate slots to the pre-drilled holes of the headboard (A).
5. Tighten using the supplied Allen key (E).
6. If the Headboard is unstable, adjust the leveler underneath the legs to stabilize the Headboard assembly as seen in the illustration below.
7. Assembly is complete. Periodically tighten all connections.

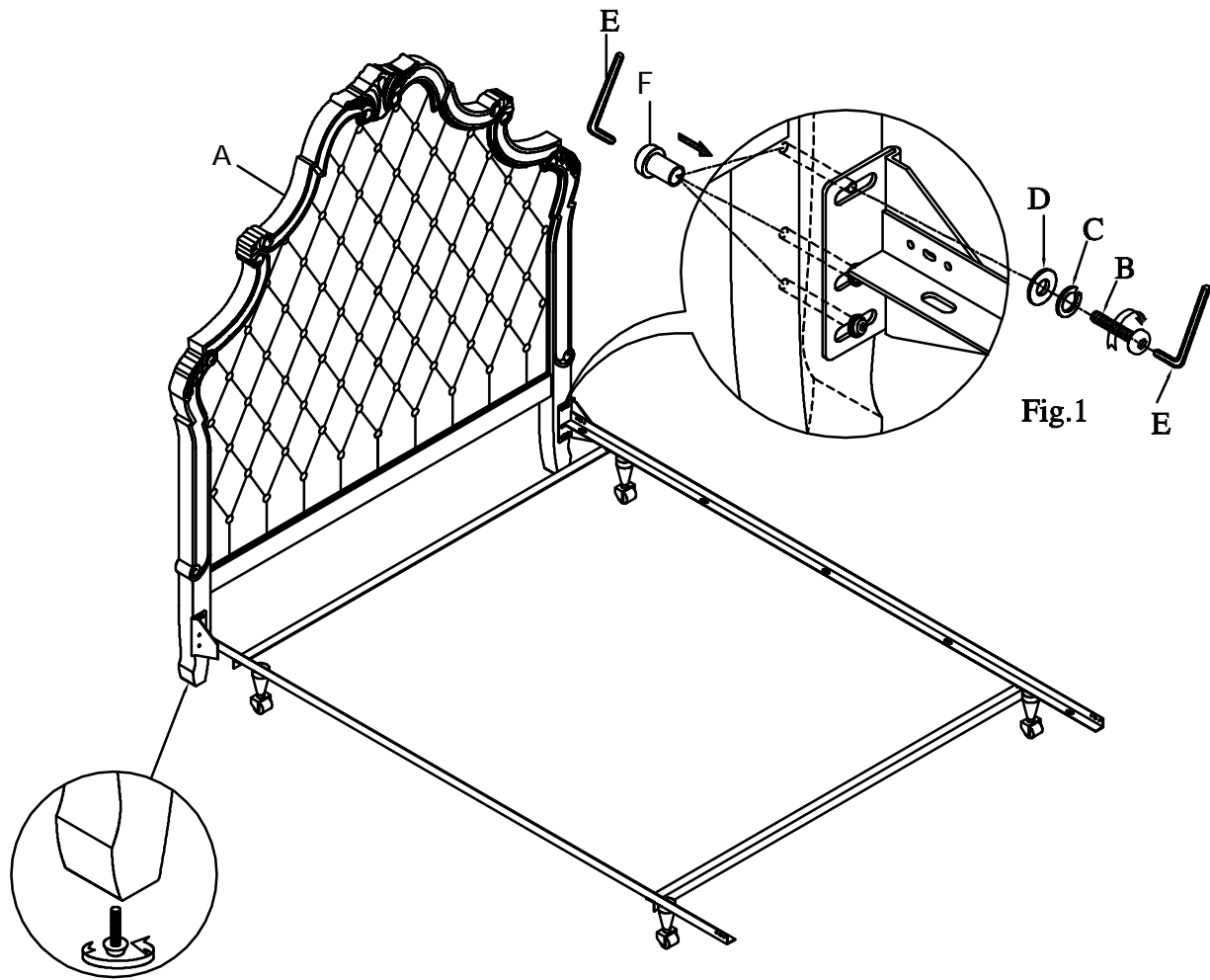

Care Instructions:

- Dust often using a clean, soft, dry, and lint-free cloth.
- Blot spills immediately and wipe with a clean, damp cloth.
- We do not recommend the use of chemical cleansers, abrasives, or furniture polish on our lacquered finish.
- Hardware may loosen over time. Periodically check to make sure all connections are tight and re-tighten if necessary.