

E AND M BUNNY EARS DESK CHAIR

Important Safety Instructions:

- Please read all instructions carefully before assembling.
- For your safety, assembly by two or more adults is strongly recommended.
- Keep instructions for future use.
- Use only vendor supplied hardware to assemble. Using unauthorized hardware could jeopardize the structural integrity of the item.

Pre-assembly:



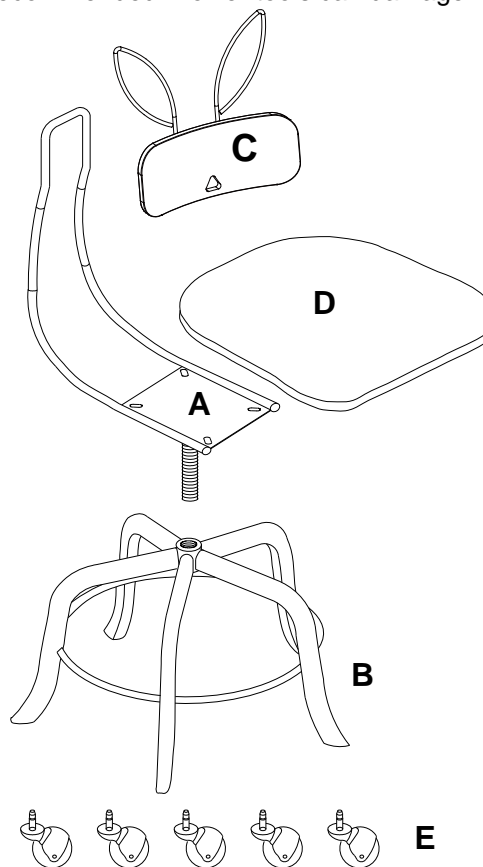

- Remove all parts and hardware from the box and lay out on a clear carpeted or scratch-free work surface, as this will avoid damaging parts during assembly. The shipping box provides an ideal work surface.
- Do not dispose of any packaging or contents of the shipping carton until assembly is completed to avoid accidentally discarding small parts or hardware.
- Use the parts and hardware lists below to identify and separate each of the pieces included.
- The illustrations provided allow for easier assembly when used in conjunction with the assembly instructions.
- The use of power tools to aid in assembly is not recommended. Power tools can damage hardware and split wood.

Parts Included:

- (A) Seat Frame 1x
- (B) Chair Base 1x
- (C) Chair Backrest 1x
- (D) Seat 1x
- (E) Ball Caster 5x

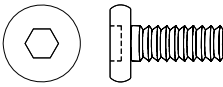

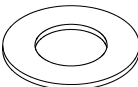
Hardware Included:

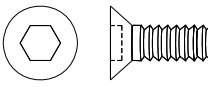
<p>(F) Long Bolt</p>  <p>M6 x 16mm 4 pcs</p>	<p>(G) Spring Washer</p>  <p>4 pcs</p>	<p>(H) Flat Washer</p>  <p>4 pcs</p>	<p>(I) Lock Nut</p>  <p>1pc</p>	<p>(J) Short Bolt</p>  <p>M6 x 12mm 1pc</p>
---	---	---	---	--

Tools Required:

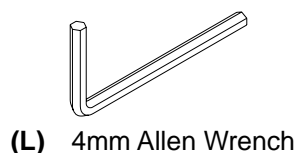

Assembly Instruction Steps:

1. Insert ball casters (E) to Chair Base (B) by pressing firmly until casters locked.

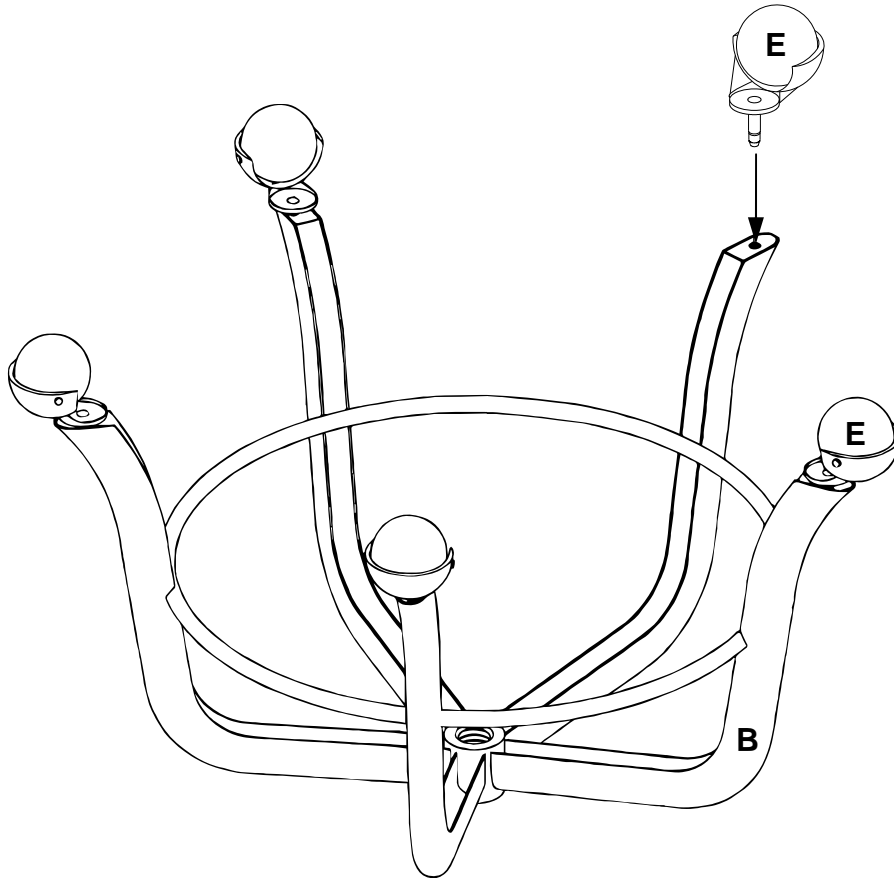

2. Attach seat frame (A) to seat (D) using M6mm long bolts (F), spring washers (G) and flat washers (H). Tighten by hand first and then securely tighten with 4mm Allen wrench (L).

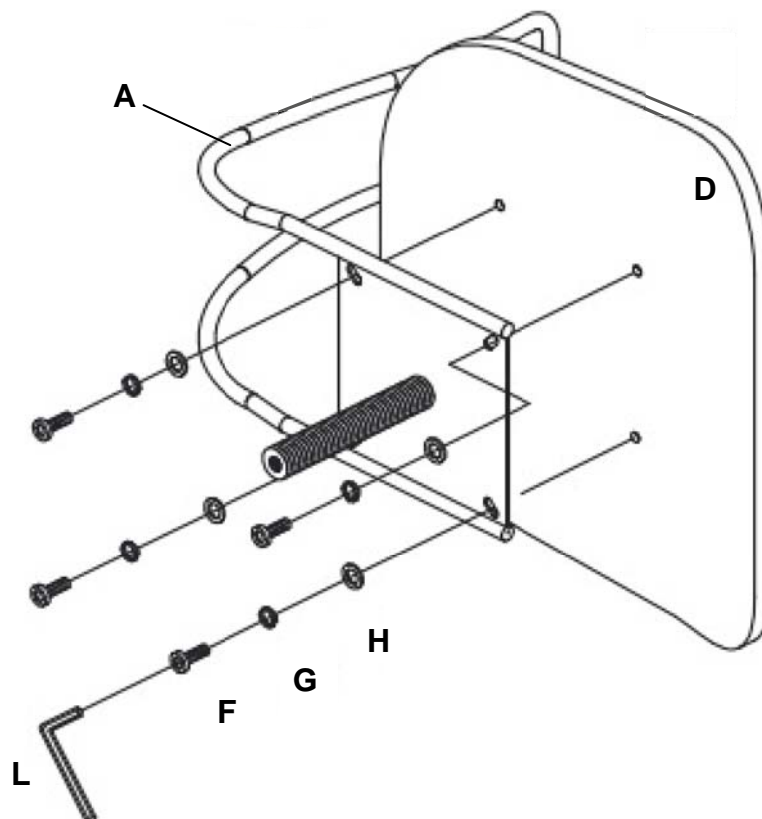

3. Screw the seat frame (A) into the chair base (B) to desired height.

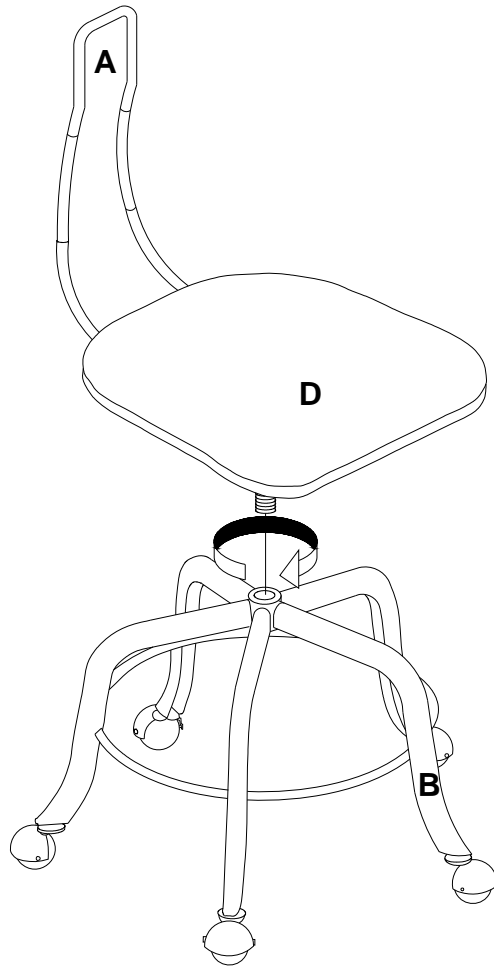

4. Attach lock nut (I) to the bottom of seat frame post using M6mm short bolt (J). Tighten with 4mm Allen wrench (L) as shown.

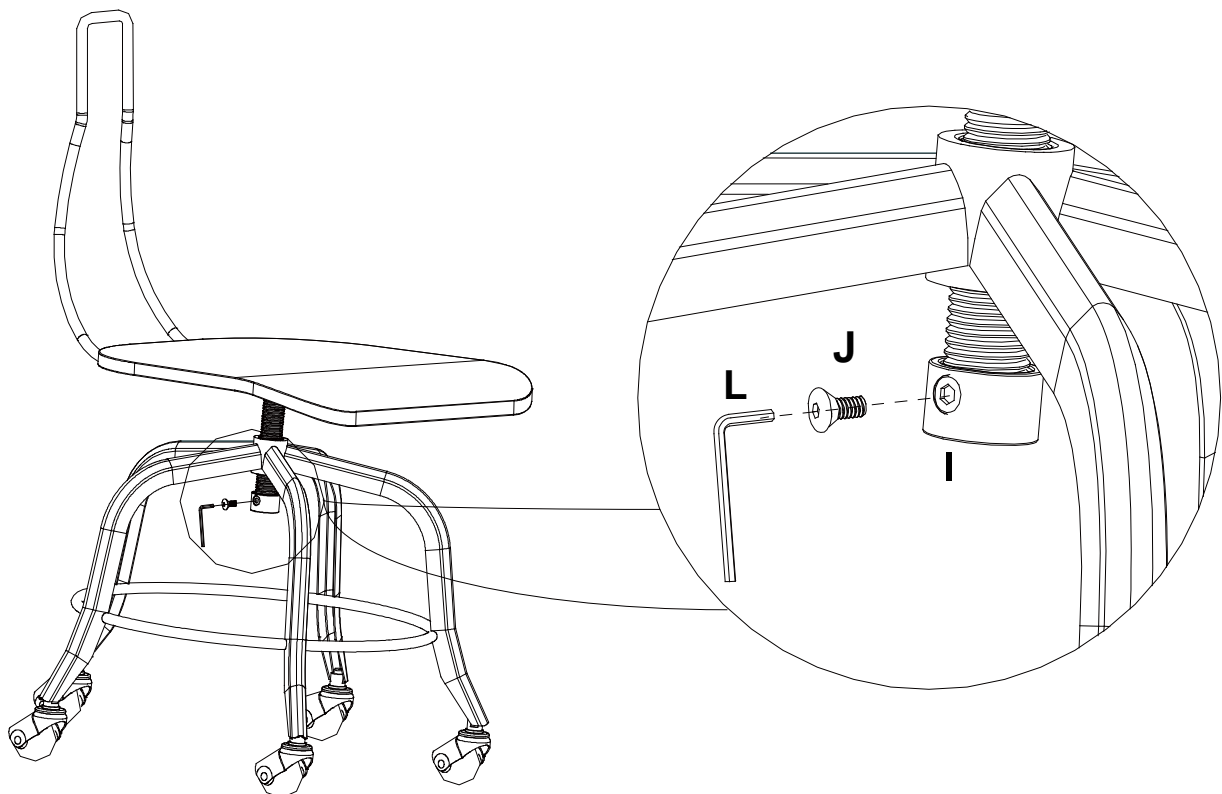

5. Unscrew clamp with turning knob anticlockwise as shown.

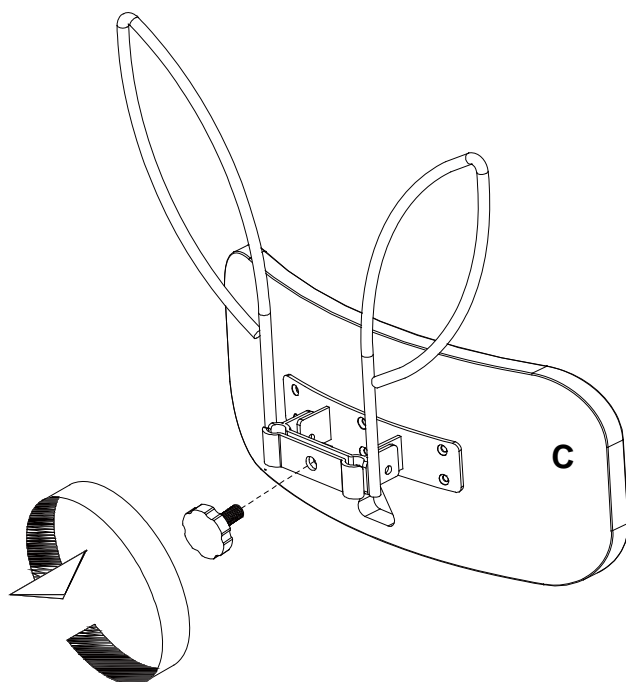

6. Put the chair backrest (C) on seat frame (A) and then re-attach clamp with turning knob clockwise.

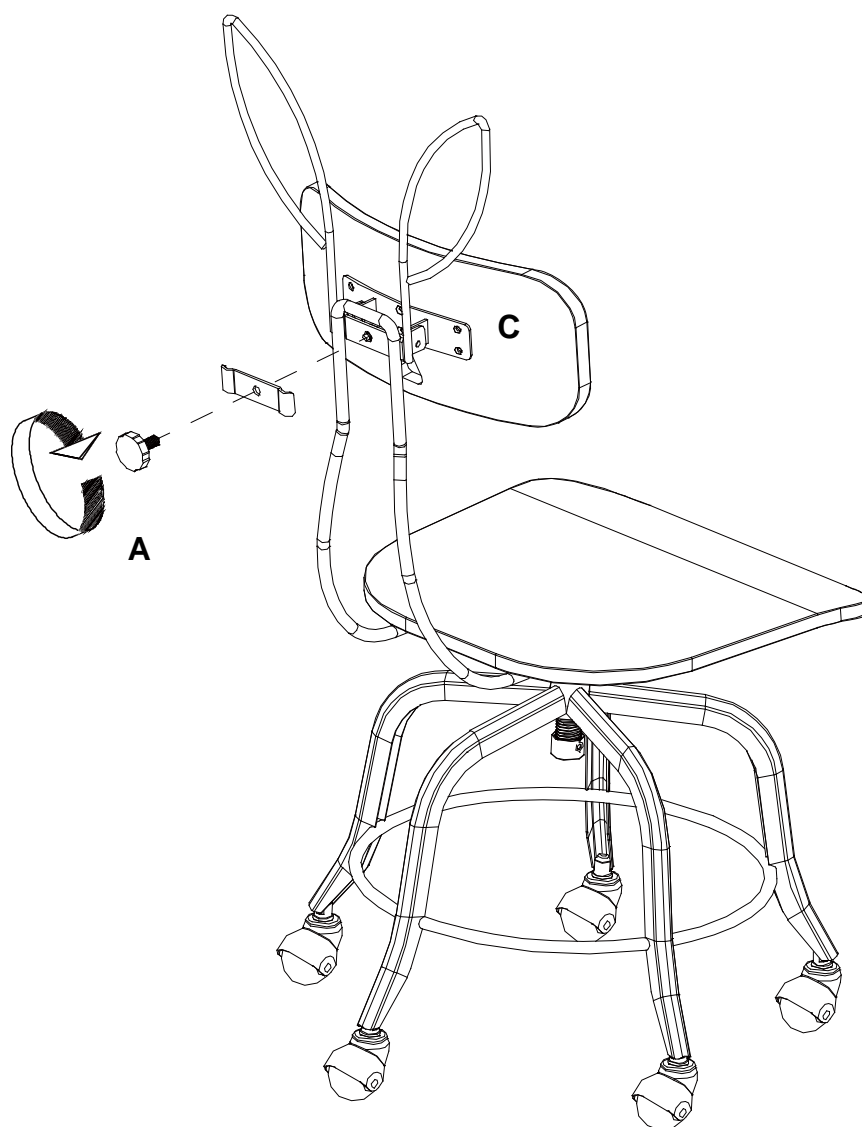

7. Check to make sure all bolts are securely tightened. Assembly is complete!
The chair backrest can be adjusted freely to fit you back.

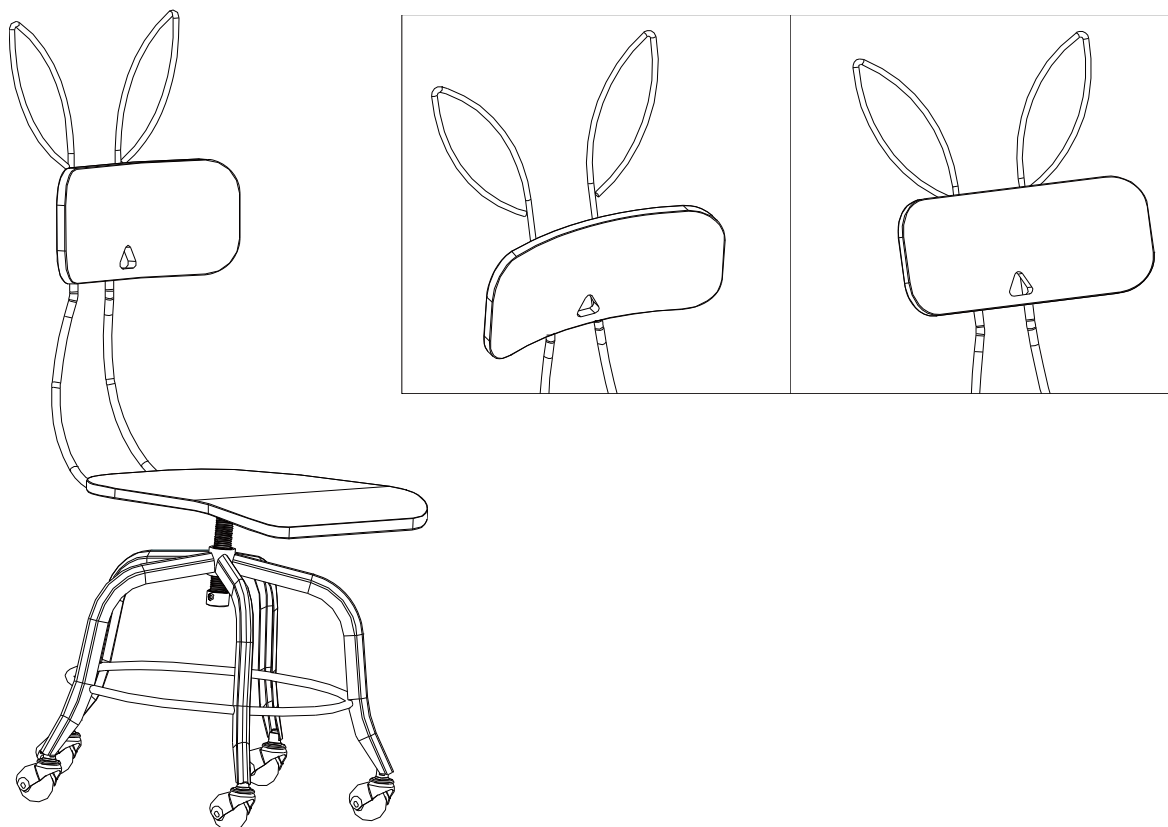

Care Instructions:

- Dust often using a clean, soft, dry and lint-free cloth.
- Blot spills immediately and wipe with a clean, damp, cloth.
- We do not recommend the use of chemical cleansers, abrasives or furniture polish on our lacquered finish.
- Hardware may loosen over time. Periodically check to make sure all connections are tight.
Re-tighten if necessary.

Thank you for your purchase
Stores | catalog