

**Stainless Kitchen Stove**  
**Cuisinière en acier inoxydable pour la cuisine**  
**Cocina de acero inoxidable**



Warning! Adult Assembly required

Mise en garde! Un adulte doit assembler cet article.

Advertencia! El ensamblaje debe estar a cargo de un adulto.

## ENGLISH

- Do not dispose of any packaging or contents of the shipping carton until assembly is completed to avoid accidentally discarding small parts or hardware.
- **Do not mix old and new batteries.**
- **Do not mix alkaline, standard (carbon-zinc), or rechargeable batteries.**

## FRANÇAIS

- Ne jetez rien des produits d'emballage et du contenu de la boîte jusqu'à ce que l'assemblage soit terminé, afin d'éviter de jeter par mégarde de petites pièces ou des morceaux.
- **Ne pas mélanger les anciennes et les nouvelles piles.**
- **Ne pas mélanger les piles alcalines, standard (carbone-zinc) ou rechargeables.**

## ESPAÑOL

- Para evitar desechar accidentalmente las partes pequeñas o las piezas de ferretería, no tirar el embalaje o contenido de la caja hasta que el ensamblaje esté completo.
  - **No mezclar baterías nuevas y usadas.**
  - **No mezclar baterías alcalinas, estándar (carbón-zinc), o baterías recargables.**
- 

### Care Instructions:

- Dust often using a clean, soft, dry and lint-free cloth.
- When blot spills, wipe with a clean, damp cloth immediately.
- We do not recommend the use of chemical cleansers, abrasives or furniture polish on our lacquered finish.
- Hardware may loosen over time. Periodically check to make sure all connections are tight. Re-tighten if necessary.

### Instructions d'entretien :

- Épousseter régulièrement avec un chiffon propre, doux et non pelucheux.
- Éponger immédiatement les liquides renversés et essuyer à l'aide d'un chiffon propre et humide.
- L'utilisation de produits nettoyants chimiques, d'abrasifs ou d'encaustiques sur nos finitions laquées n'est pas recommandée.
- Le matériel de fixation peut se desserrer avec le temps. Vérifiez régulièrement afin de vous assurer que tous les raccords sont bien serrés. Resserrez-les au besoin.

### Instrucciones de cuidado:

- Limpiar el polvo con un trapo limpio, suave, seco y libre de pelusas.
- Secar los derrames de inmediato y limpiar con un trapo limpio y húmedo.
- Recomendamos no usar limpiadores químicos, abrasivos o lustramuebles sobre el acabado barnizado.
- Las piezas de ferretería pueden aflojarse con el tiempo. Controlar periódicamente que estén bien ajustadas. Si es necesario, volver a ajustarlas.

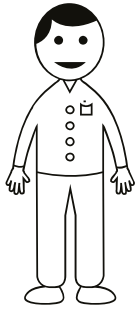

**X2**

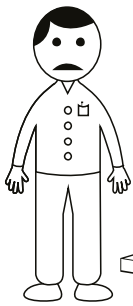
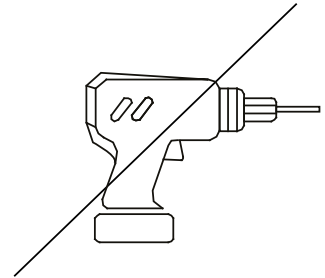
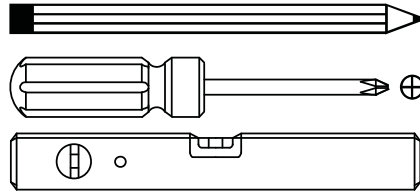

?

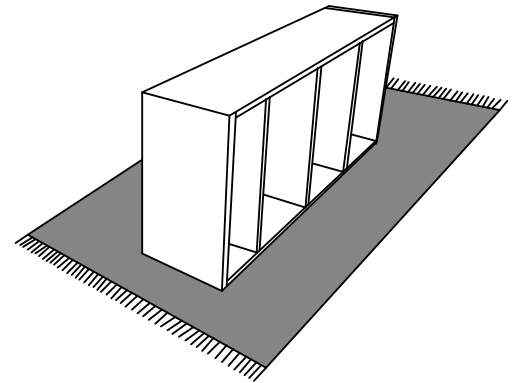
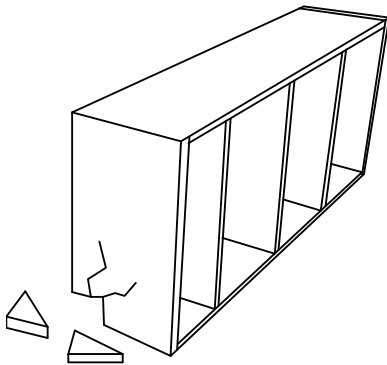
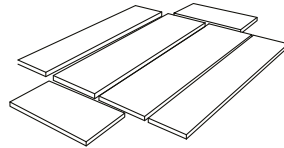
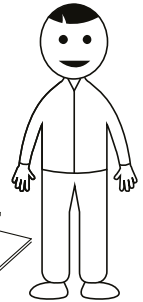
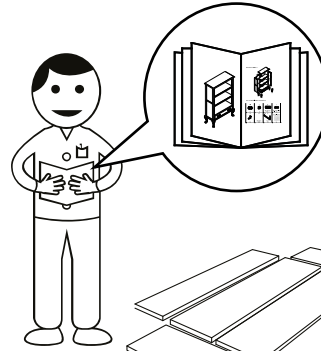
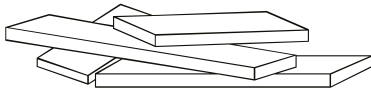
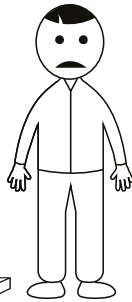

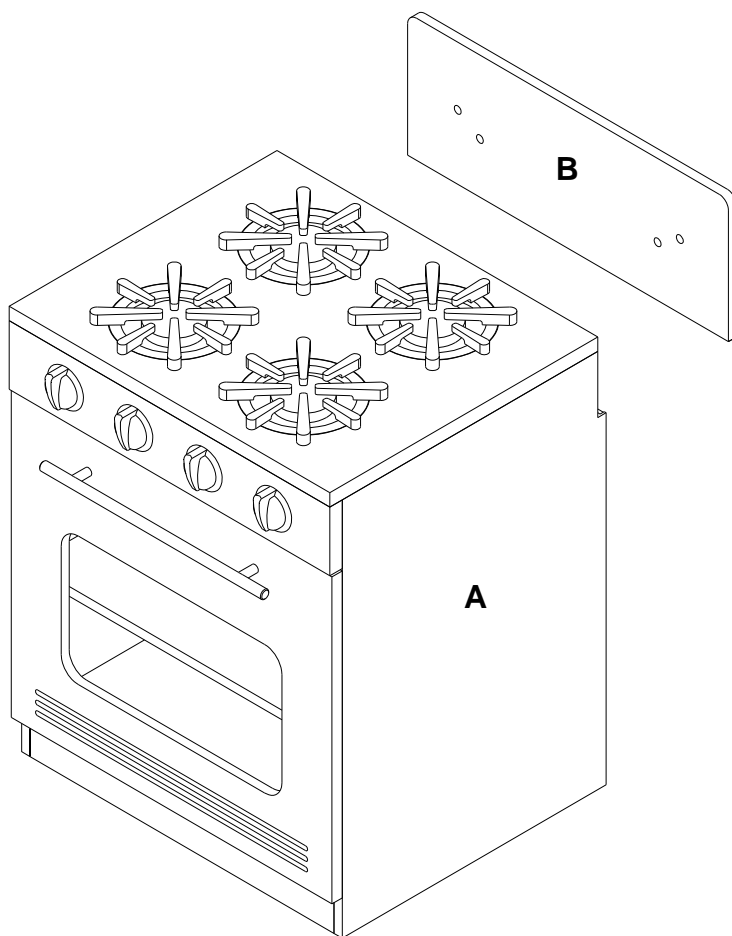

**C**

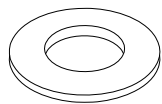

**4 x**

**D**

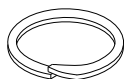

**4 x**

**E**

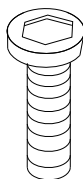

**4 x**

**F**

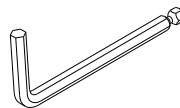

**1 x**

1

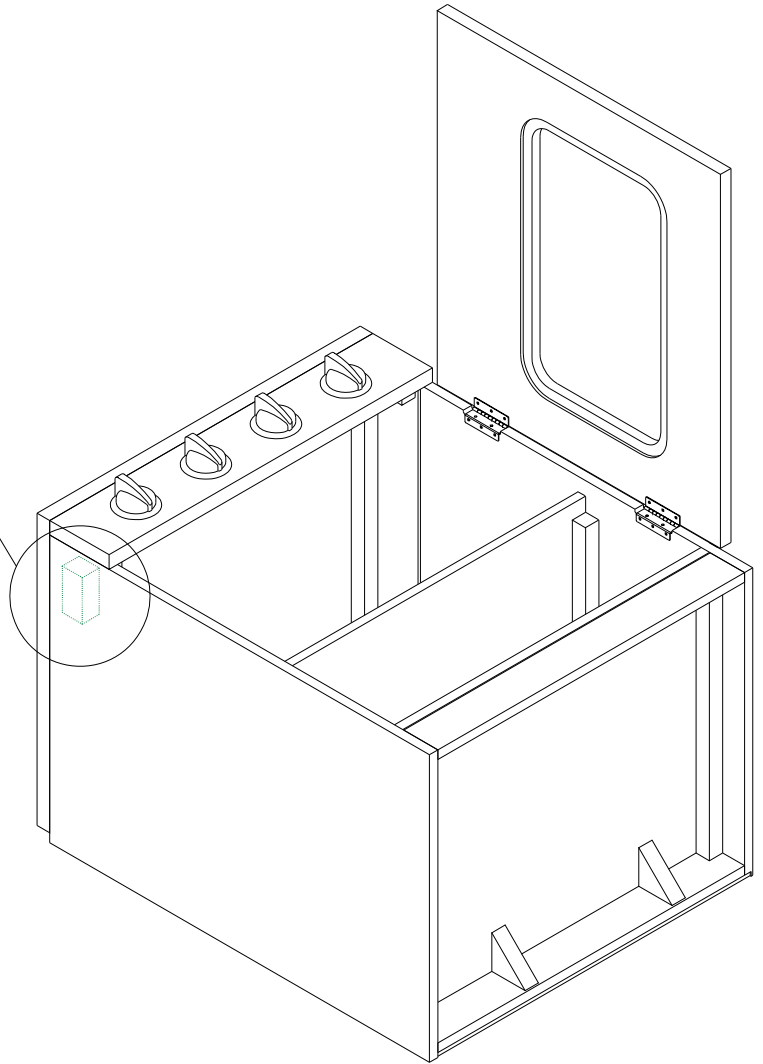
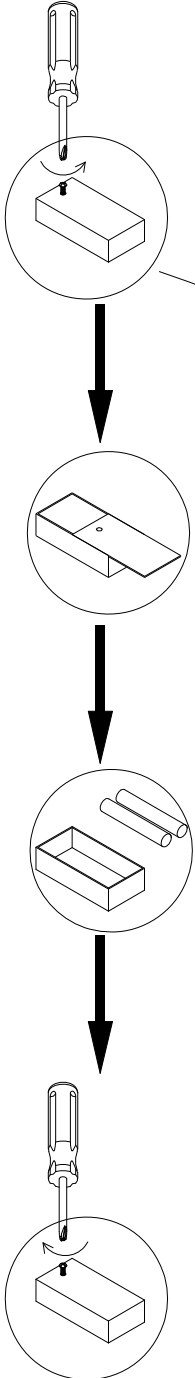

2pcs AA battery is not included.  
2 piles AA non incluses.  
No se incluye la batería de 2 piezas AA.

## 2

