

VIEW5 (1:10)

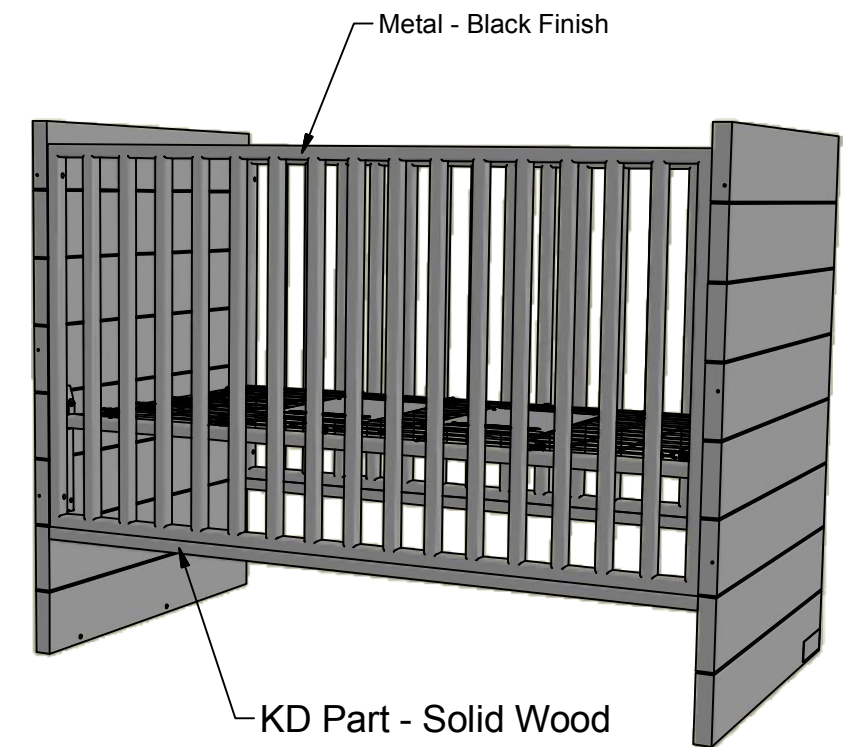
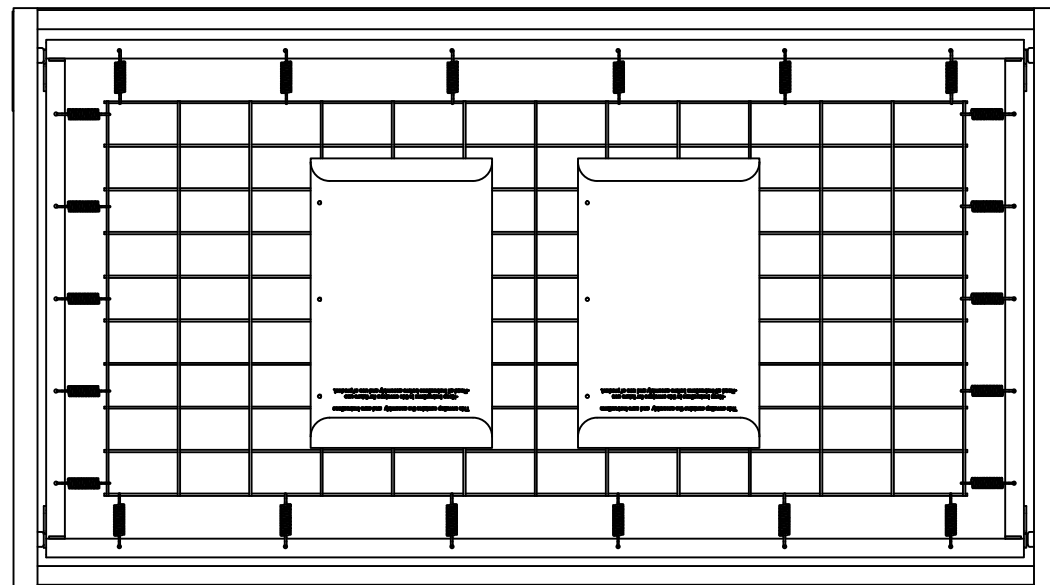

← Grain Direction

All exposed edges R=3mm unless otherwise specified. All other edges to be broken.

All assemblies to be well glued together and permanent joints mechanically fastened.

Designed by Jean-Paul Dumouchel	Drawn by Luc pitre	Approved by - date	Date 8/15/2017
pottery barn kids		Grayson Crib	
		01-002273-02	Edition Sheet 1 / 13

EXCLUSIVE AND CONFIDENTIAL PROPERTY OF WILLIAM SONOMA, INC.
2013 William-Sonoma, Inc. All rights reserved, including all applicable copyright,
design and patent rights.

2



1

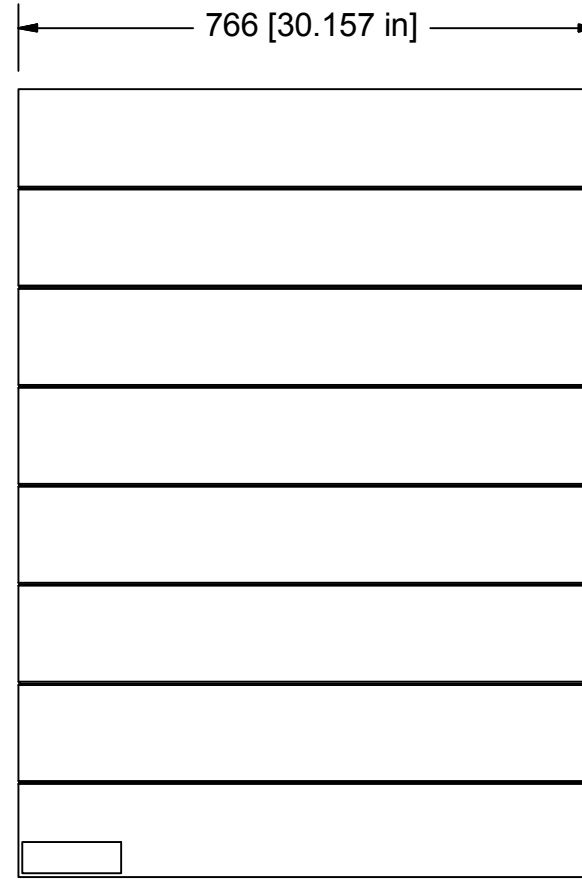
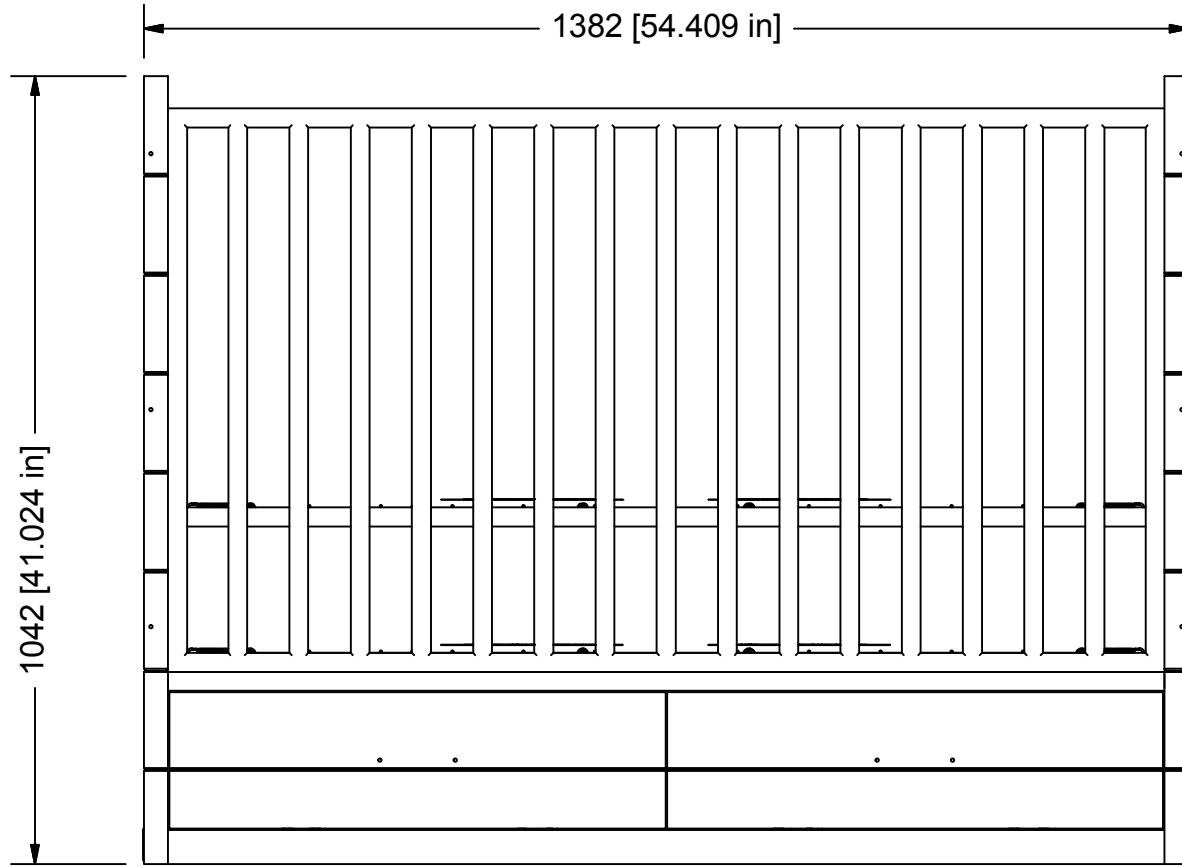

VIEW40 (1:10)

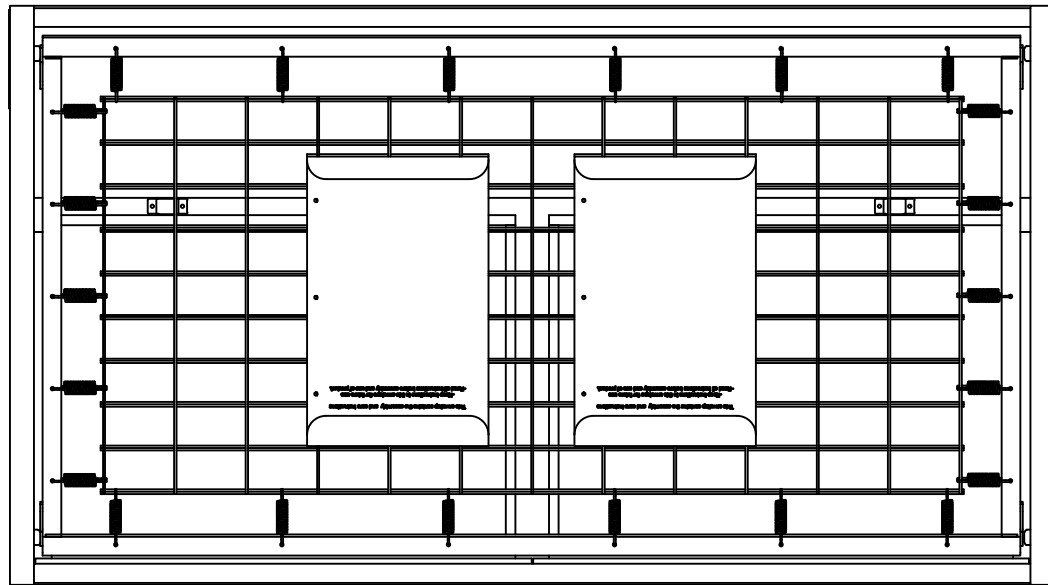

Designed by Jean-Paul Dumouchel	Drawn by Luc pitre	Approved by - date	Date 8/15/2017
---------------------------------------	-----------------------	--------------------	-------------------

pottery barn kids	Grayson Crib	
	01-002273-02	Edition Sheet 2 / 13

2



1

B

B

A

A

1. DEFECT LOCATIONS, ZONE A-B-C :

- All defect locations are as per the WSI Quality Assurance Inspection Manual for Furniture unless other stated below under exception:

2. WOOD MATERIALS

- Wood materials must be as per WSI approved wood species list.

3. CONSTRUCTION / WORKMANSHIP:

- All glue joints must be clean and tight with no gaps present. Glue coverage must be even and thorough along entire joint; no "glue-starved" joints permitted. Where necessary joint must be locked in place with mechanical fasteners such as small nails (brads).
- Components such as door stiles & rails, posts, chair legs, canopy rails, framing rails, moldings etc.. must be made of straight grain wood in order to prevent warpage and twist. It is recommended to edgeglue such components whenever possible.
- Panels to be edge glued - width of lamellas 50-60mm.
- Construction of top panel (when applicable): lumber rim - 5-ply construction. Width of solid lumber rim to be 30mm on all 4 sides unless otherwise specified on drawings.
- MDF, particleboard & plywood must be CARB compliant.
- "V" groove (1x1mm) must be used in all assemblies where there is potential for the finish to crack.
- Knots may not appear at edges of the boards where they may crack or come loose.
- All edges not otherwise specified should be eased.
- No splits or cracks allowed on exposed surfaces.
- No splintering of edges allowed.
- Putty or wood filler can only be used in small amount to fill defects. No putty or filler allowed once the unit has been fully lacquered.
- Small knots (max. 10mm in diameter), must be sound and tight unless otherwise specified. No knots allowed for cribs gates/slats, high chairs and bunk beds guard rails and ladder steps. On painted finishes such as white, no knots are allowed because of bleed through.
- No sharp edges/burrs allowed on metal components.
- Follow the requirements/Specifications for the following product categories:
 - Casgood Standard - Document 03-000021-xx (xx denotes latest release).
 - Bed Standard - Document 03-000016-xx (xx denotes latest release).
 - Home Office - Document 03-000019-xx (xx denotes latest release).

4. VENEER:

- Unless otherwise noted the veneer cut and layout described below will apply. This specification will apply to all veneered components such as: top panel, side panels, doors, drawer fronts, shelves, partitions, back, etc.
- NOTE: "C" surfaces, such as the underside of tops need not follow this specification unless otherwise stated.
- NOTE: Unless otherwise noted in finish specifications "A" and "B" surface veneers are to be furniture grade, clear and free of knots and voids. Veneer thickness (face and back) must range from 0.5mm to 0.8mm unless otherwise stated on product specification.
- NOTE: Wood grain direction is determined by the longest length of the component being veneered unless underwise stated on the drawing.

4.1 PLAIN SLICE, ALSO KNOWN AS FLAT CUT

- Plain sliced veneer is sliced parallel to a cut through the center of the log to achieve flat-cut veneer. Generally, this cut produces cathedrals in the grain. This appearance is formed by the inner most annual growth rings as the veneer is cut through the flitch. In slices closer to the center of the log the grain may appear more close and straight, with no cathedrals. Much of the yield will appear as if it is "quarter cut."

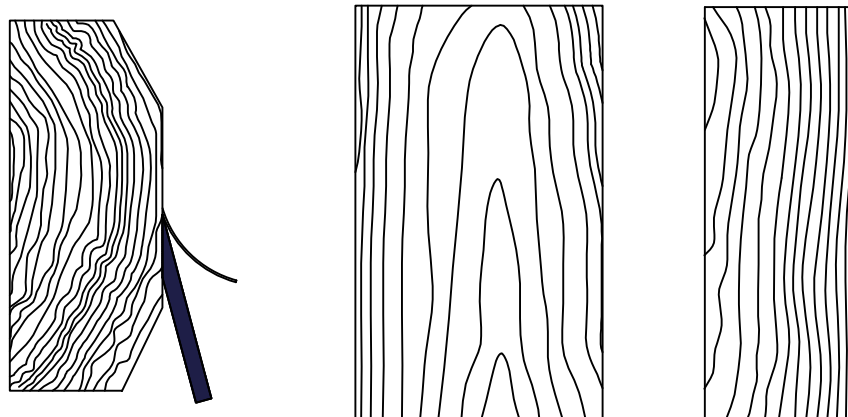

4.2 RANDOM MATCH LAYOUT, 75 MM to 160 MM

- Veneer leaves are to measure from 75mm wide to 160mm wide, and are placed next to each other in a random size, order, orientation, and randomly spliced edge to edge, producing a "board-by-board" effect in many species. This is to produce a casual or rustic appearance, as though individual boards from a pile were randomly applied to the product. Conscious effort is made to mismatch grain at joints. Degrees of contrast and variation should change from panel to panel.

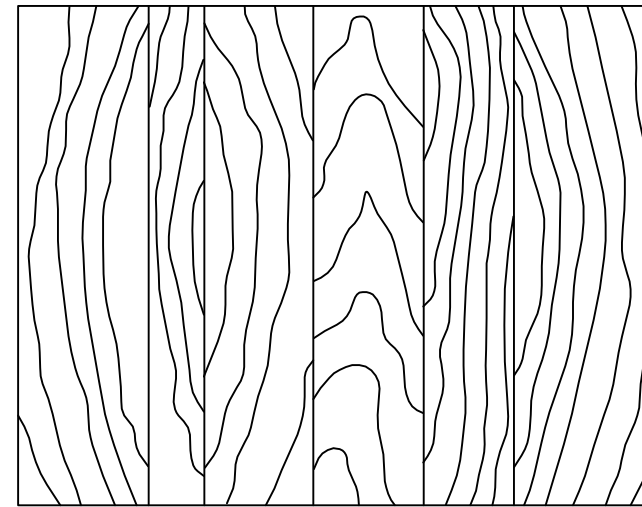

5. FINISH

- Finish must be according to color sample.
- Pigmented lacquer (ex. White, black etc..) must be applied over clear surfaces(knot free).
- All excess glue, dust, splinters; metal and other foreign residue must be removed from all surfaces prior to finishing.
- All wood surfaces should be painted and properly sealed. All concealed surfaces must be sealed as to retain evenness.
- Edges or surface that may move due to the nature of the wood and/or construction must be finished. To prevent bare_wood from being exposed, framed panels must be lacquered and/or pre-stained (edges only) prior to sub-assembly.
- All exposed wood surfaces must match in color.
- Finish surface must be clean, smooth, and free of dirt, dust, and other foreign materials on all exposed surfaces.
- Finish surfaces should be free of drips, handling marks, scratches, rubs, and other surface defects, which would be noticeable to the consumer.

6. PACKAGING:

- Packaging meeting Williams-Sonoma/Pottery Barn Packaging standards documents as identified in the contract review and must be approved by a testing agency approved by Pottery Barn before shipment of production units.
- The vendor is responsible for paying for the cost of the packaging testing process, unless otherwise specified.
- No identifying marks from the factory or vendor may appear anywhere on the unit or the packaging (except for the labeling information as specified in the Williams-Sonoma Packaging Manual).

7. LABELING:

- When applicable, special labeling may be required.

8. PRODUCTION AND TESTING SAMPLES:

- A production quality sample must be approved by WSI prior to final purchase orders.
- This product must be tested by an approved testing agency to ensure it meets WSI standards. An approved testing report must be obtained from the testing agency prior to start production.
- The vendor is responsible for paying for the cost of the test, unless otherwise specified.
- Vendor to supply full CAD (AutoCAD.dwg) Drawings and Details with samples.

***NOTE: Do not deviate from the above unless approve by WSI Furniture Engineer, or otherwise specified in the body of the drawing.**

Designed by Jean-Paul Dumouchel	Drawn by Luc pitre	Approved by - date	Date 8/15/2017
pottery barn kids		Grayson Crib	
		01-002273-02	Edition Sheet 3 / 13

2



1

VIEW9 (1:10)

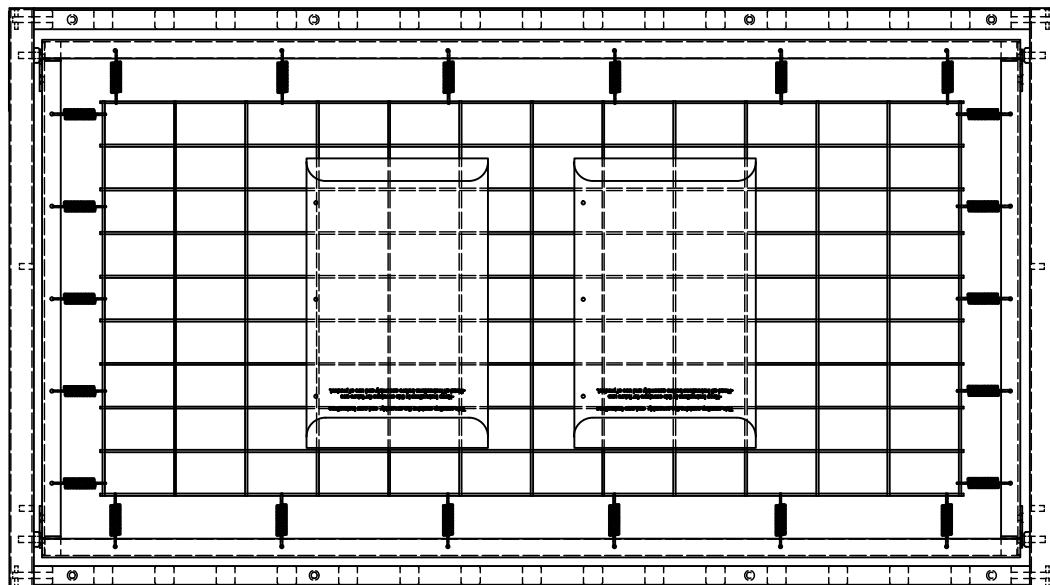
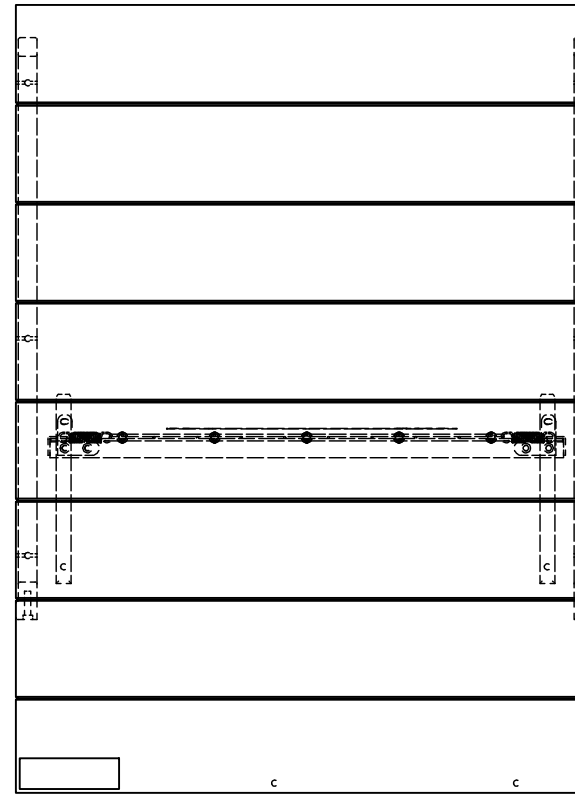
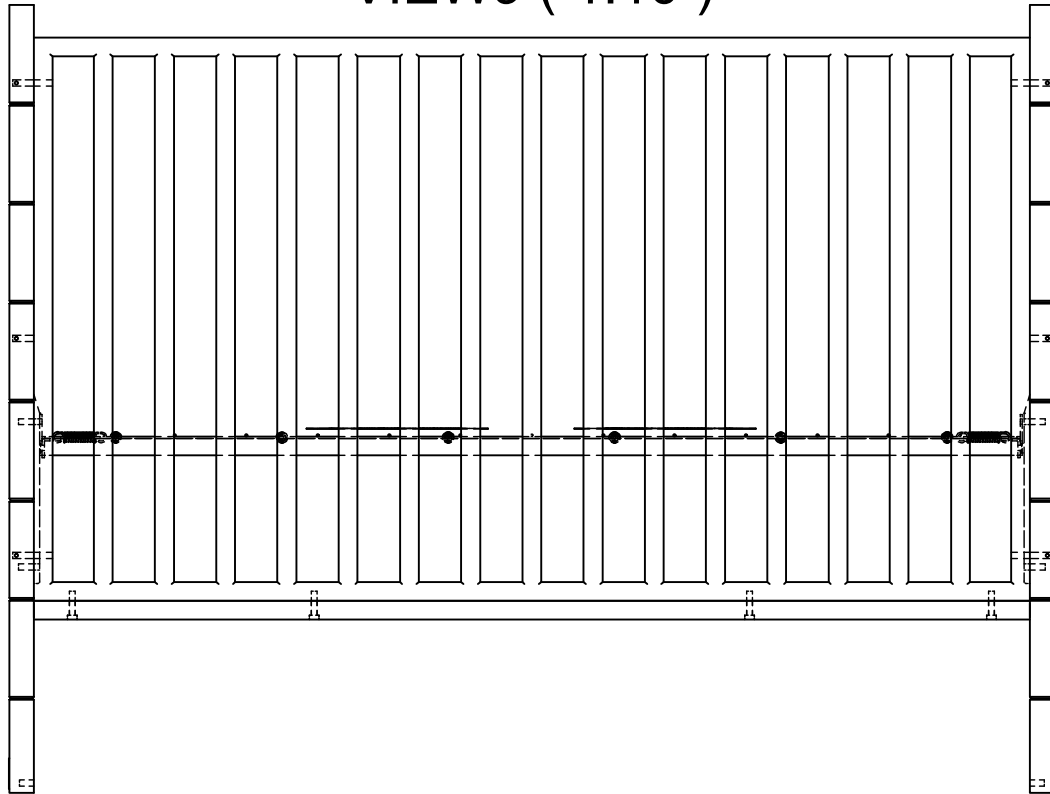

Designed by Jean-Paul Dumouchel	Drawn by Luc pitre	Approved by - date	Date 8/15/2017
pottery barn kids		Grayson Crib	
		01-002273-02	Edition Sheet 4 / 13

2



1

B

B



A

A

2



1

VIEW47 (1:10)

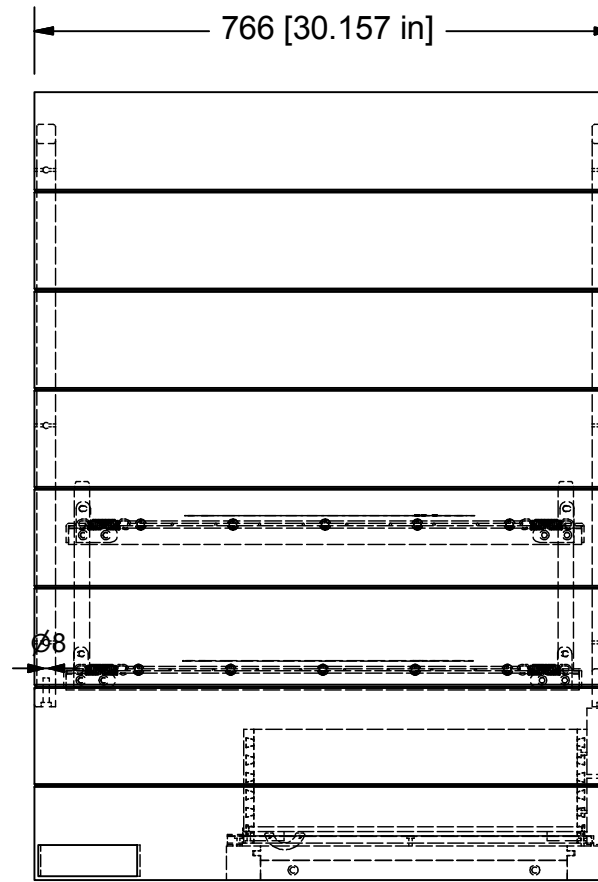
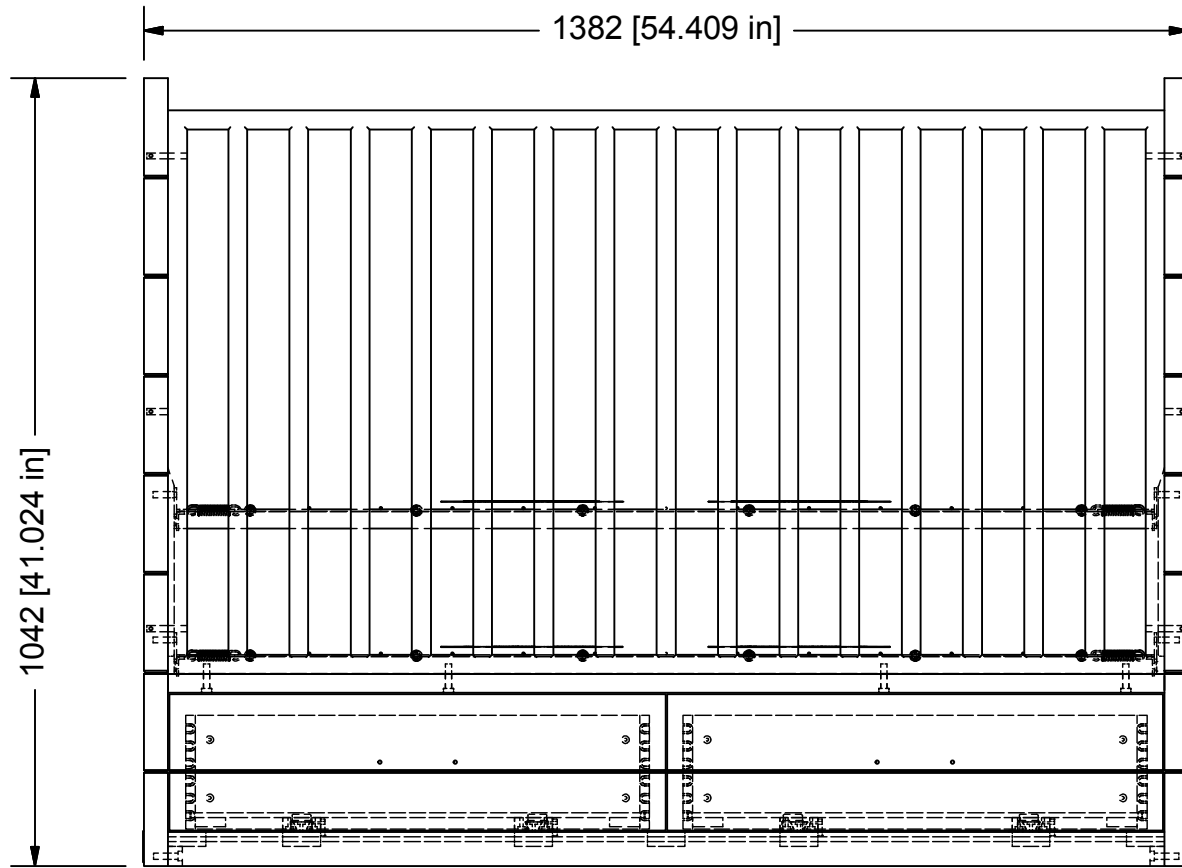

B

B

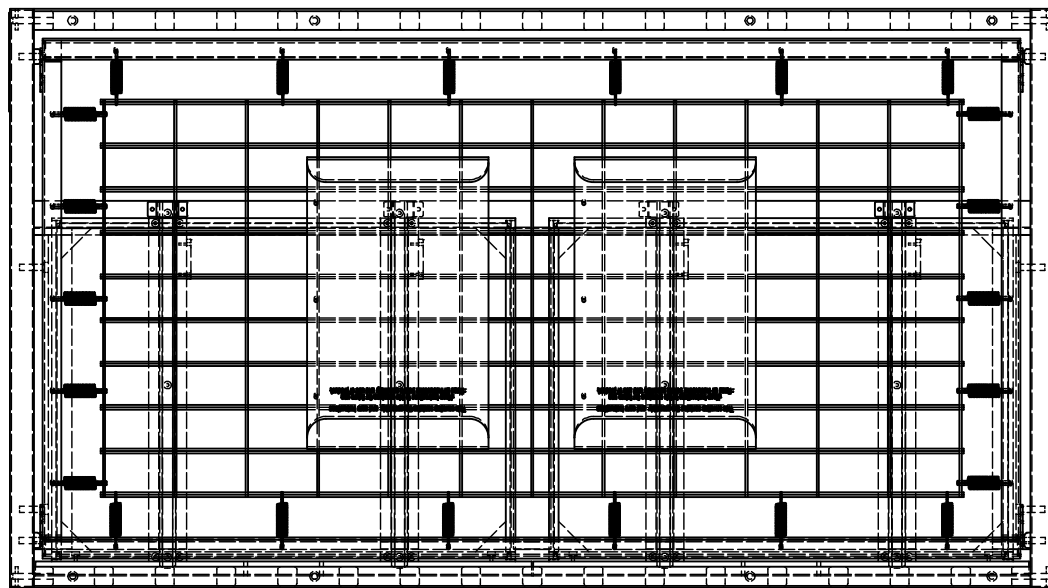

A

A

2



1

Designed by Jean-Paul Dumouchel	Drawn by Luc pitre	Approved by - date	Date 8/15/2017
pottery barn kids		Grayson Crib	
		01-002273-02	Edition Sheet 5 / 13

2

1

VIEW14 (1:6)

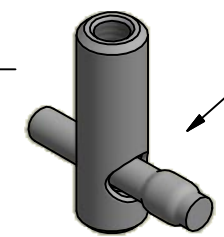
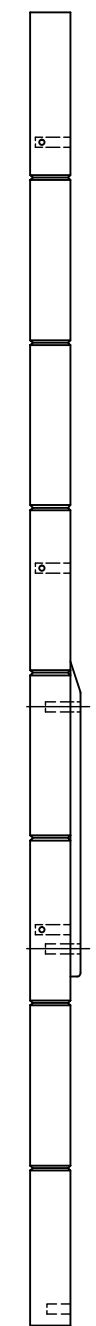
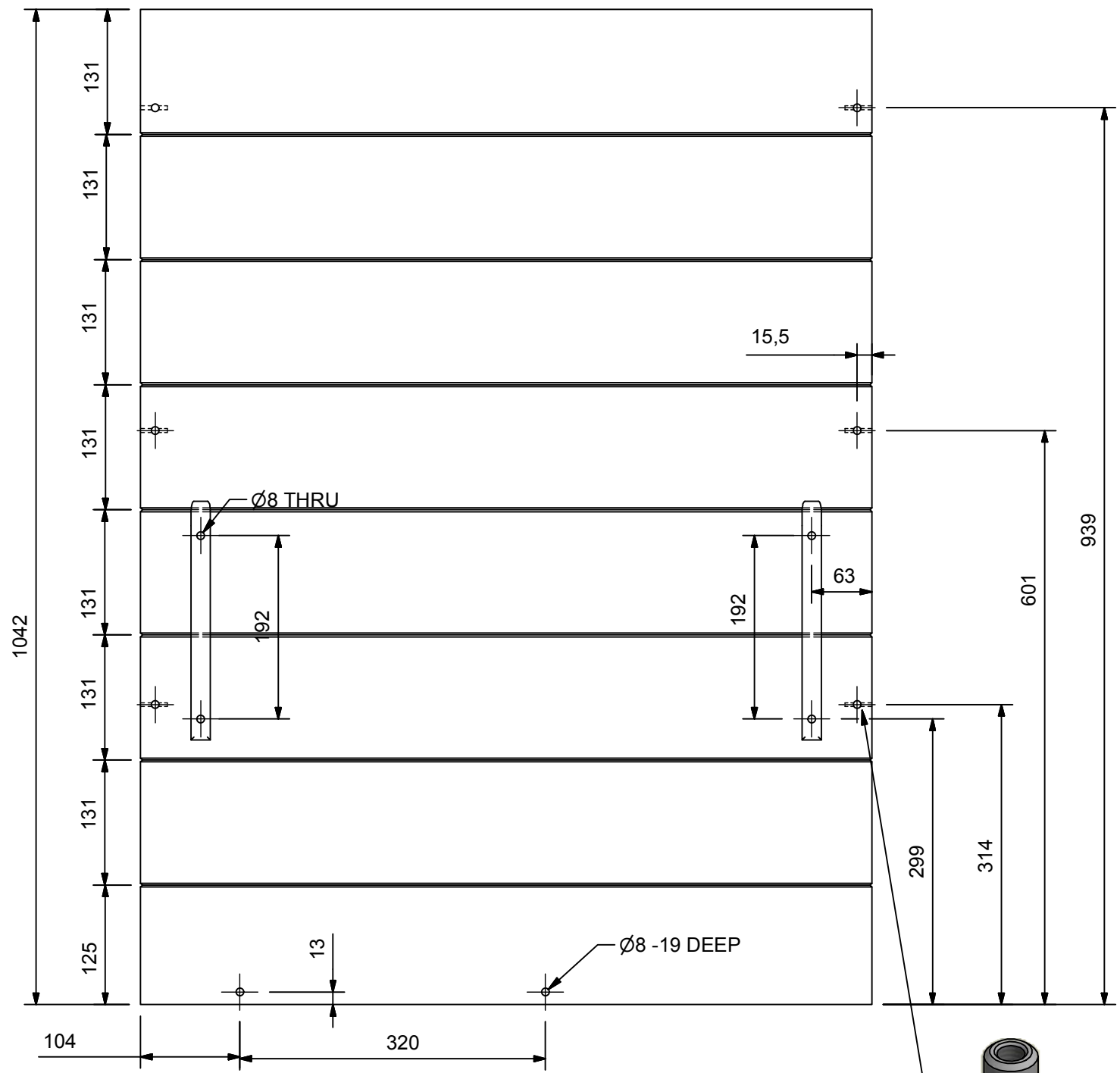

All inserts are E-Type with Pin unless otherwise specified

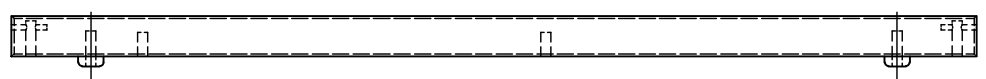

Designed by Jean-Paul Dumouchel	Drawn by Luc pitre	Approved by - date	Date 8/15/2017
pottery barn kids		Grayson Crib	
		01-002273-02	Edition Sheet 6 / 13

2

1

2



1

VIEW63 (1 : 6)

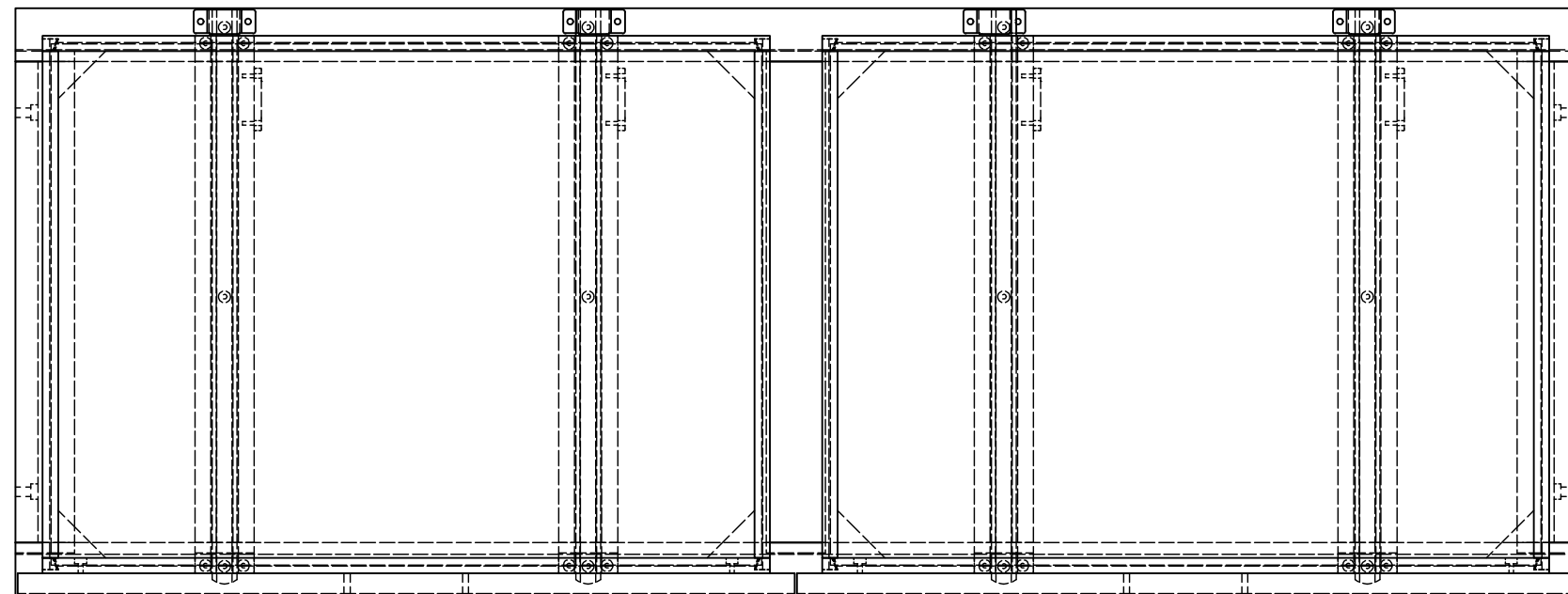
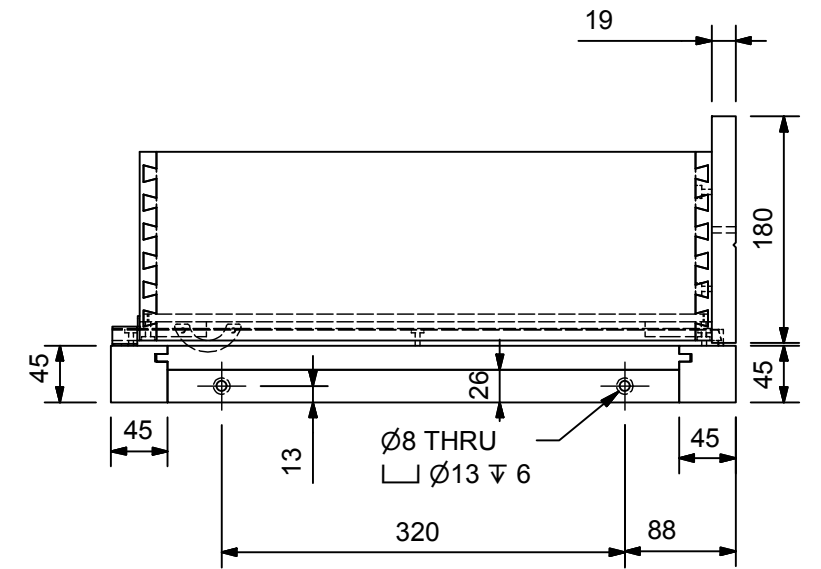
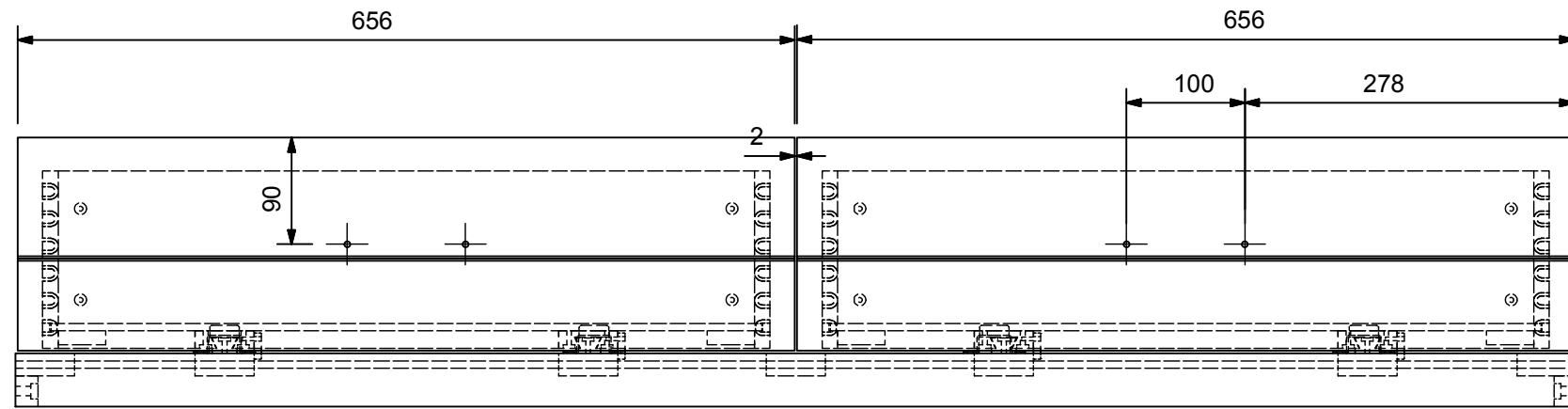

Designed by Jean Paul Dumouchel	Drawn by Luc pitre	Approved by - date	Date 8/15/2017
pottery barn kids		Grayson Crib	
		01-002273-02	Edition Sheet 8 / 13

2



1

VIEW22 (1:6)

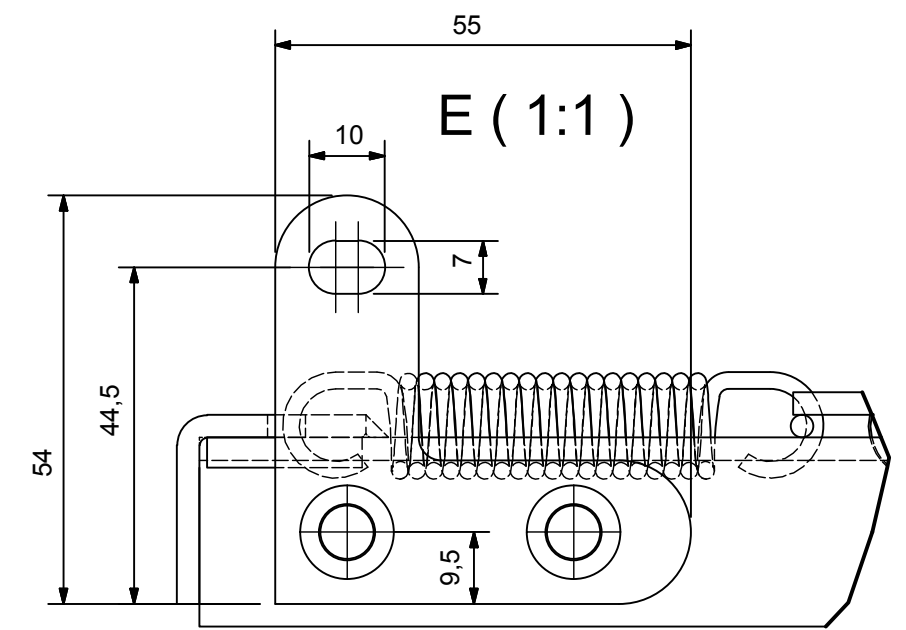
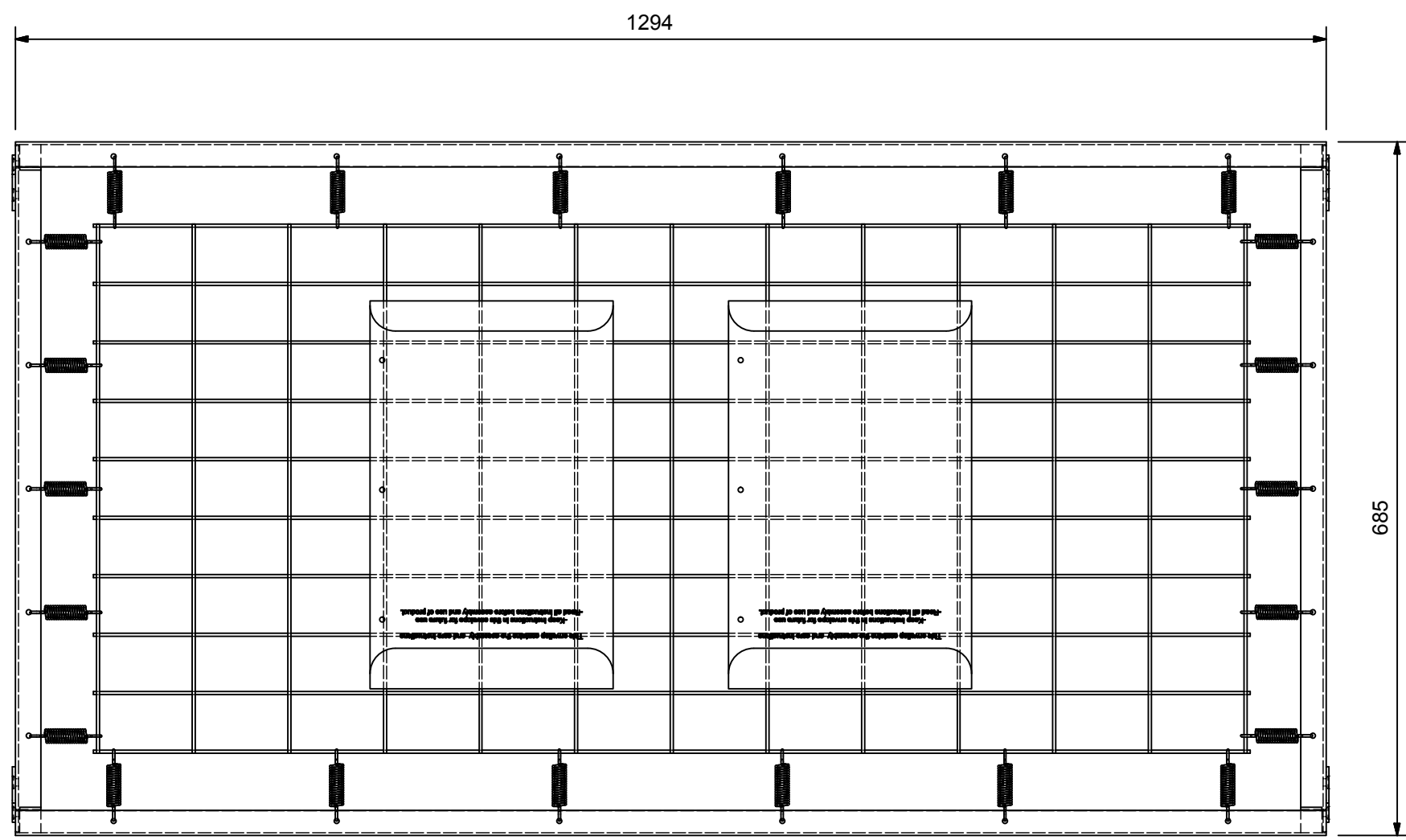
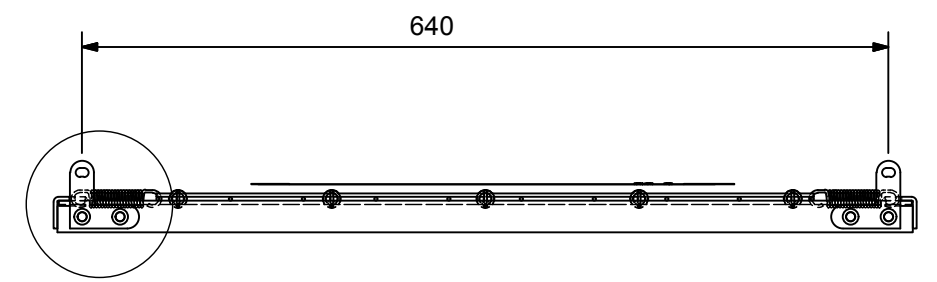
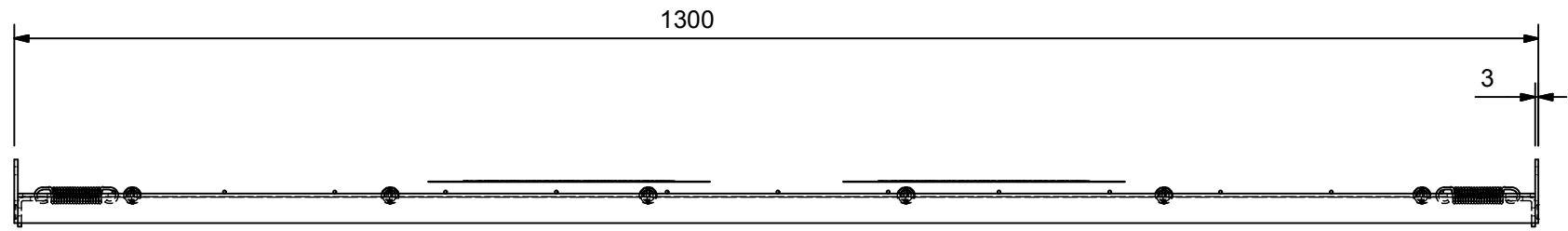

Designed by Jean-Paul Dumouchel	Drawn by Luc pitre	Approved by - date	Date 8/15/2017
pottery barn kids		Grayson Crib	
		01-002273-02	Edition Sheet 9 / 13

VIEW51 (1:10)

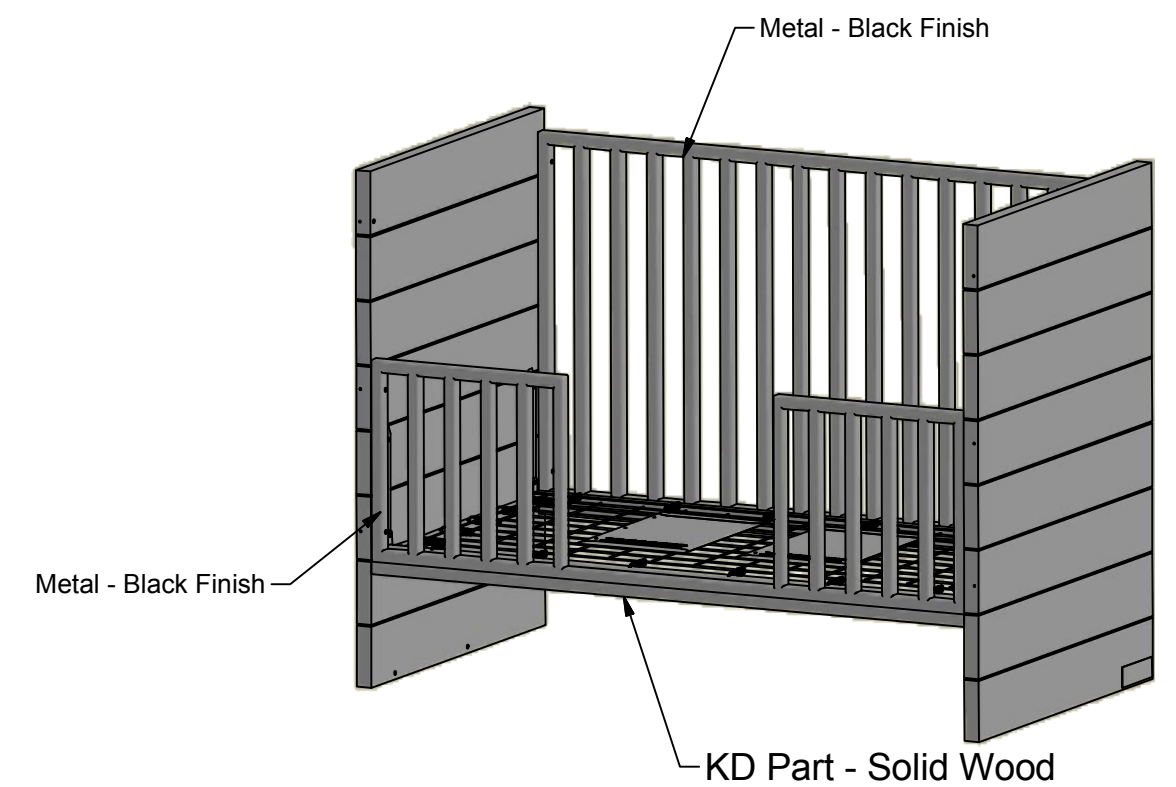
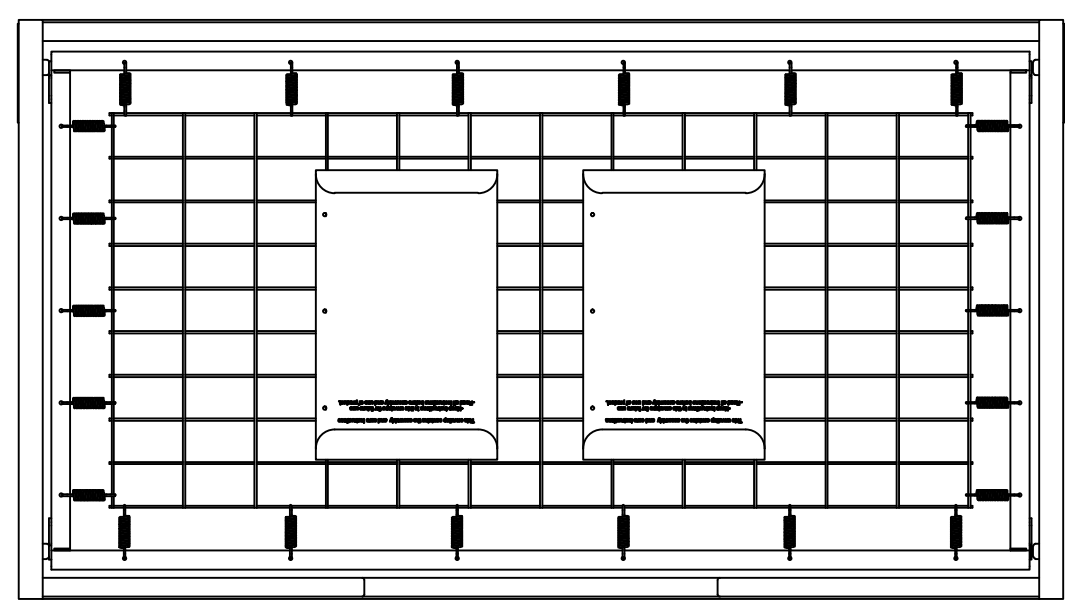
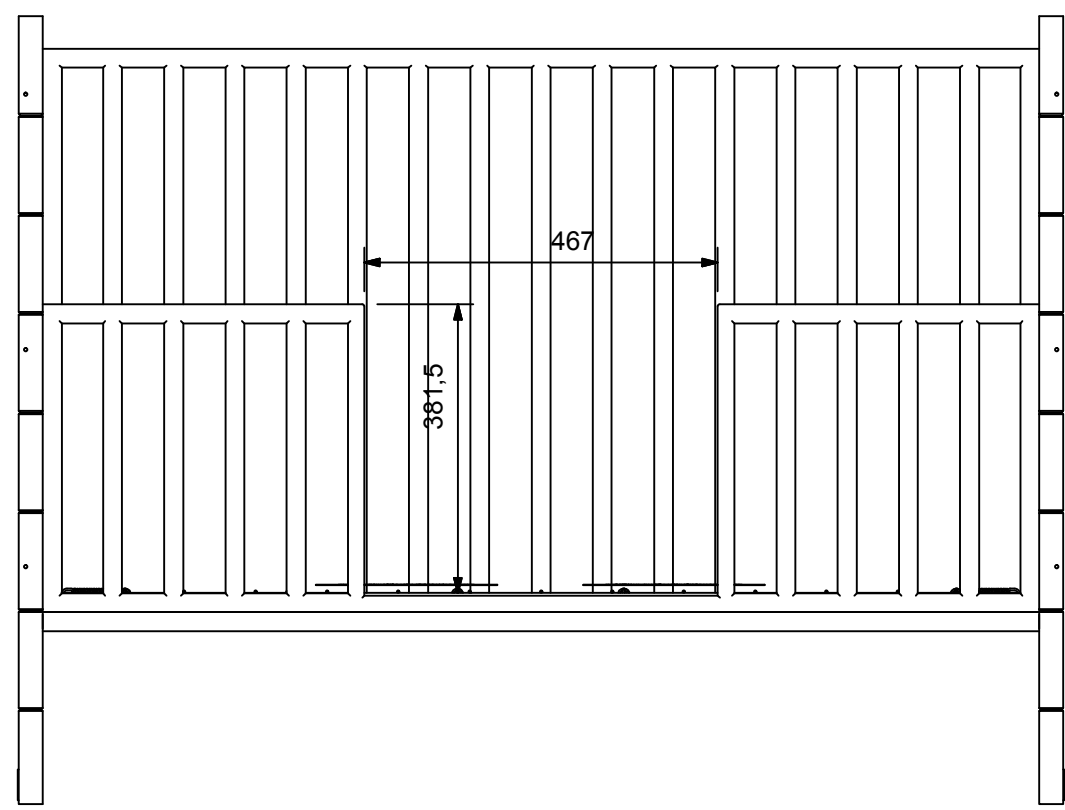

Designed by Jean-Paul Dumouchel	Drawn by Luc pitre	Approved by - date	Date 8/15/2017
pottery barn kids		Grayson Crib	
		01-002273-02	Edition Sheet 10 / 13

2

1

2

1

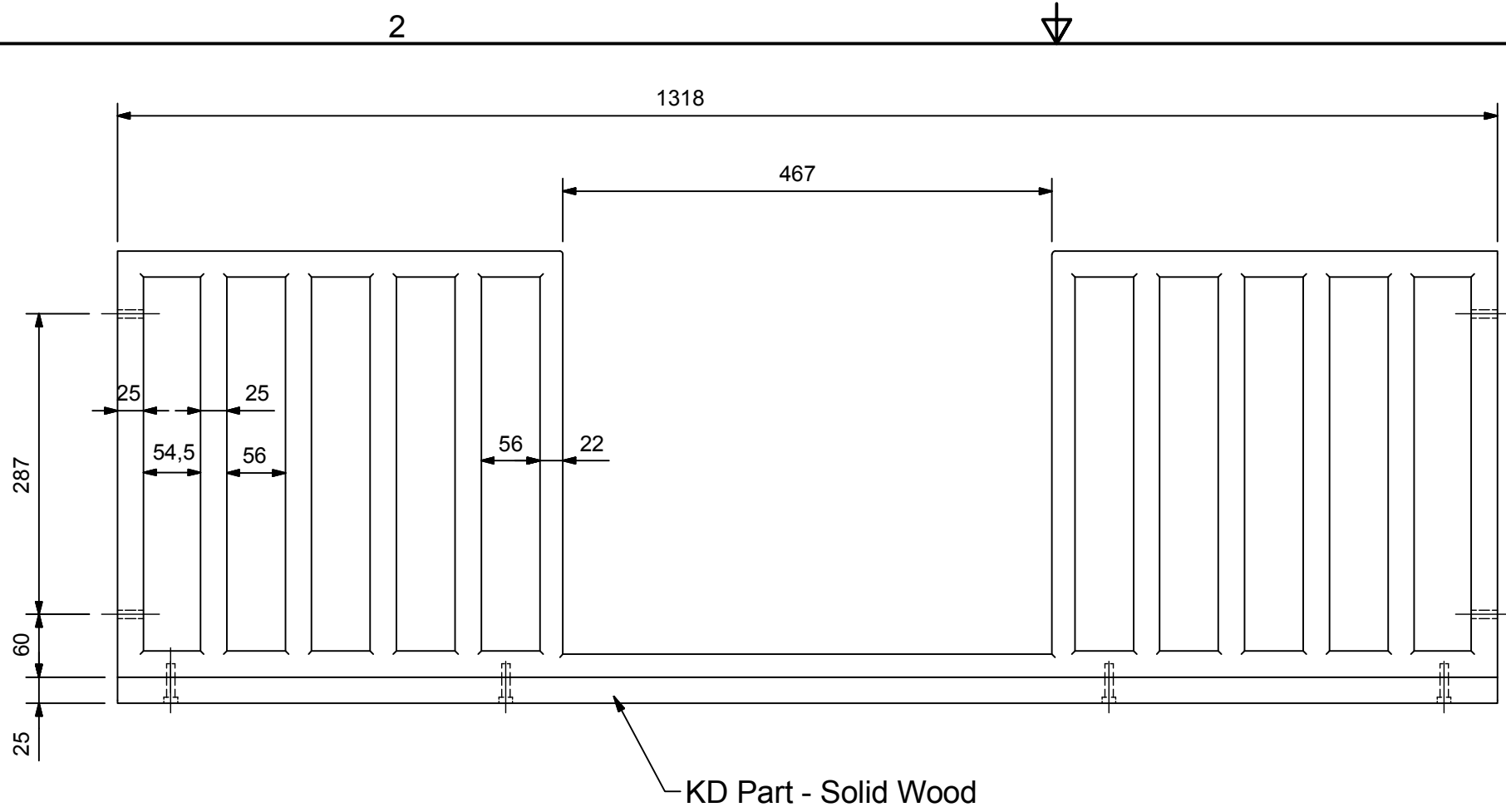

VIEW55 (1 : 6)

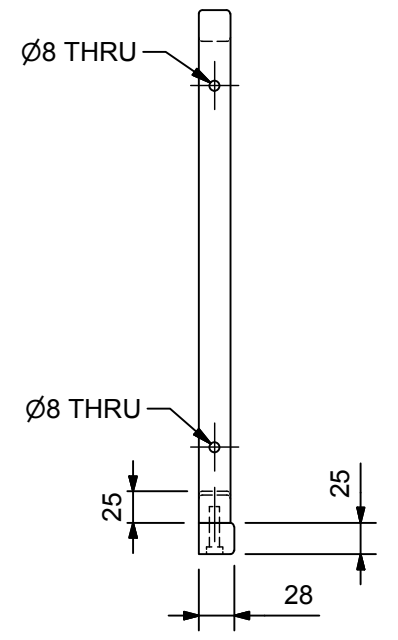

Designed by Jean-Paul Dumouchel	Drawn by Luc pitre	Approved by - date	Date 8/15/2017
---------------------------------------	-----------------------	--------------------	-------------------

pottery barn kids

Grayson Crib

01-002273-02

Edition

Sheet

11 / 13

3 Different Bolt Size.

- 1) M6x19mm
- 2) M6x32mm
- 3) M6x45mm

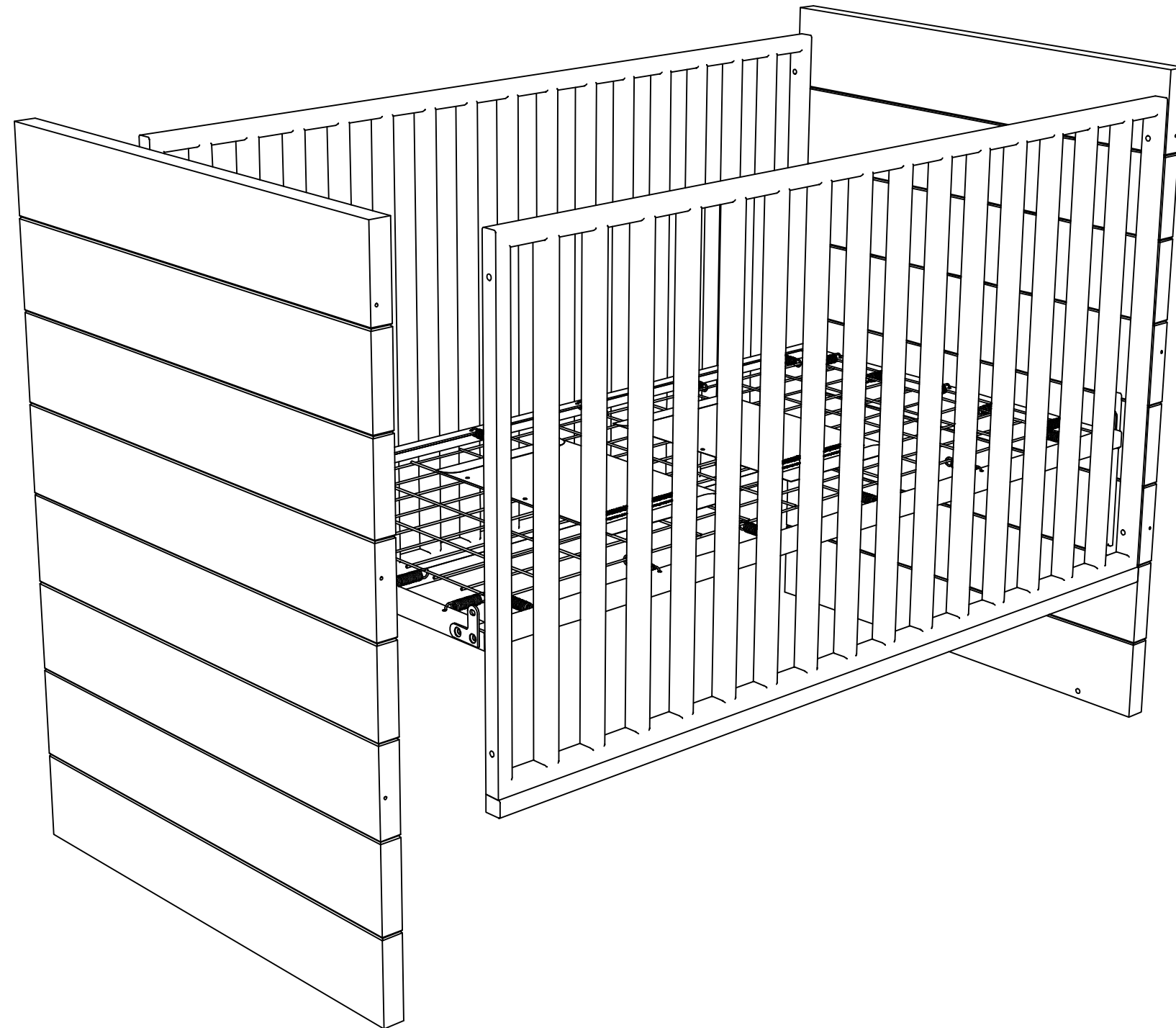

Designed by Jean-Paul Dumouchel	Drawn by Luc pitre	Approved by - date	Date 8/15/2017
---------------------------------------	-----------------------	--------------------	-------------------

pottery barn kids	Grayson Crib	
	01-002273-02	Edition Sheet 12 / 13

2

4

1

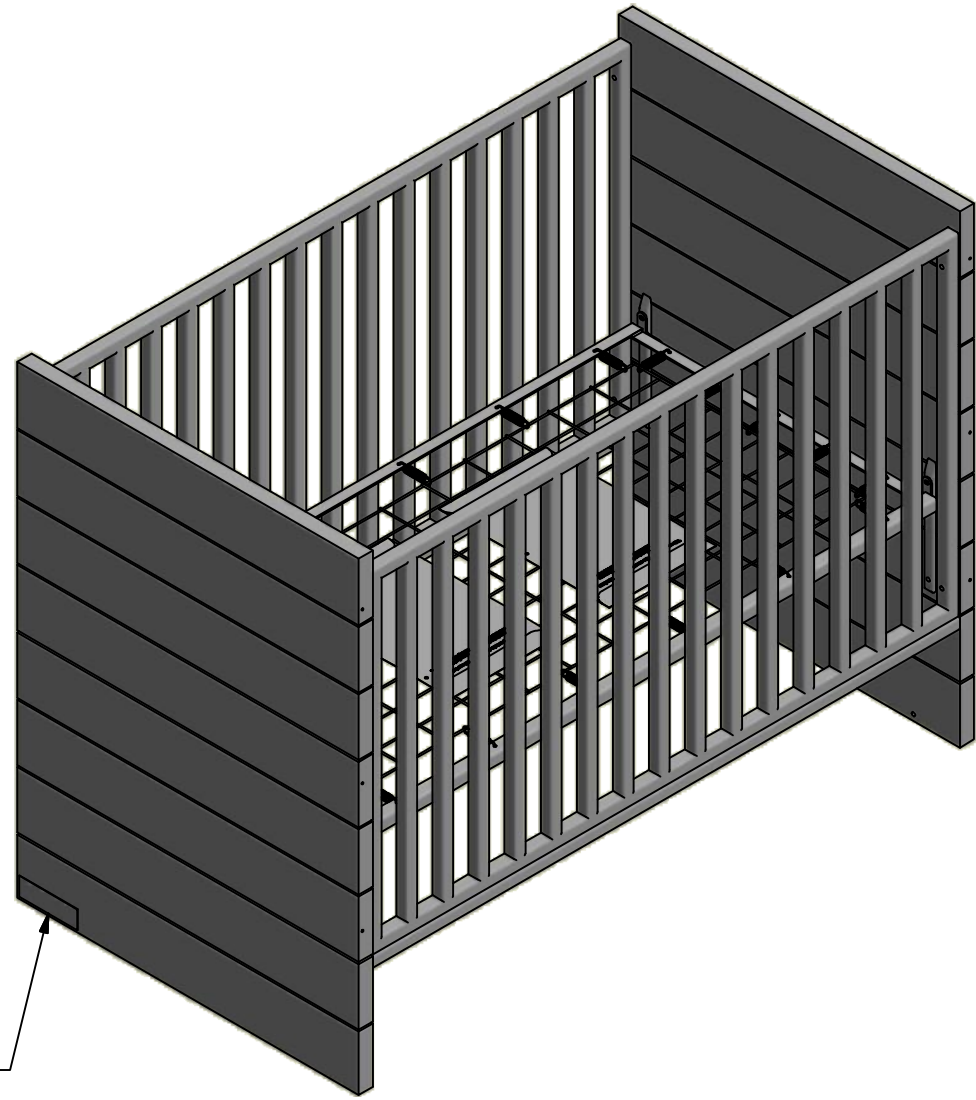

04-000141-2

Labels 04-000053-9, 04-000057-5 & 04-000061-4 are printed on the Tyvek envelop. Label 04-000047-6 is applied manually.

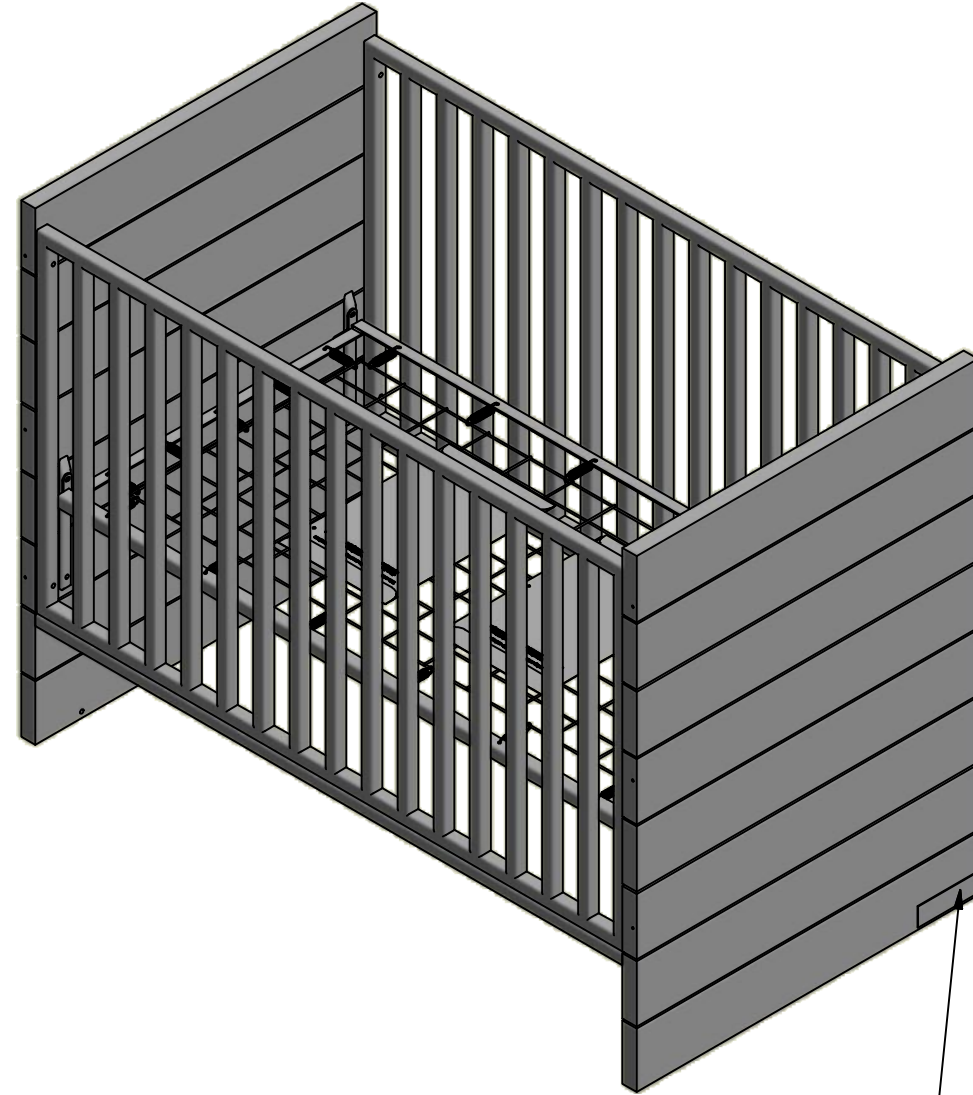

Labels 04-000224-1, 04-000225 & 04-000226 are printed on the Tyvek envelop. Label 04-000220 is applied manually. 04000141-2

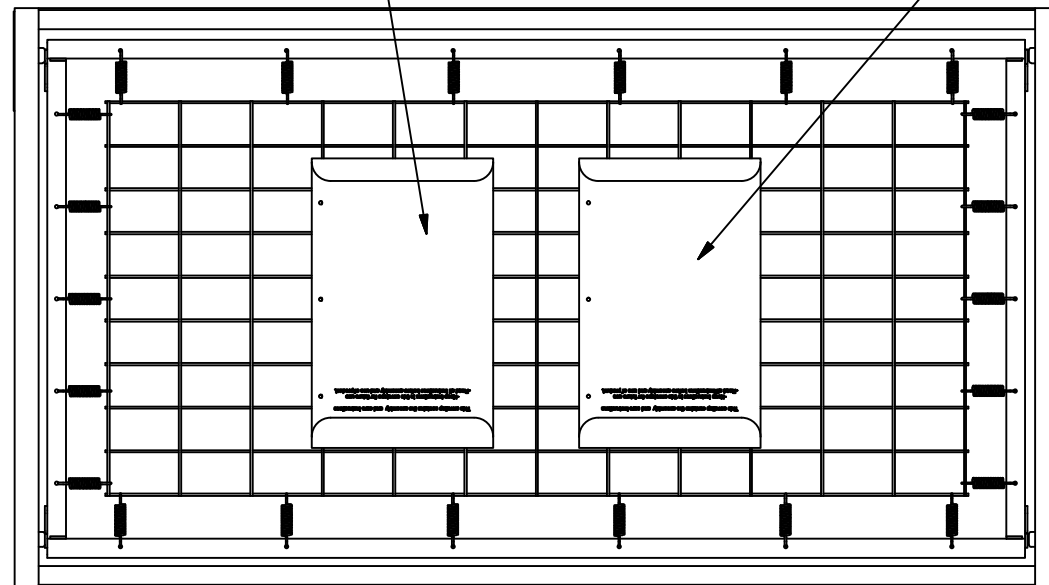

Designed by Jean-Paul Dumouchel	Drawn by Luc pitre	Approved by - date	Date 8/15/2017
pottery barn kids		Grayson Crib	
		01-002273-02	Edition Sheet 13 / 13