

POTTERY BARN

MADELINE METAL CHANDELIER

Assembly and Installation Instructions

CAUTION:

- **BEFORE INSTALLING FIXTURE, MAKE SURE THE POWER TO THE CIRCUIT IS TURNED OFF AT THE MAIN FUSE BOX / CIRCUIT BREAKER UTILITY BOX.**
- The optional conversion kit # **2746766** or **2747343** (included) is intended for use with the Madeline Metal chandelier (cord with plug style lighting fixture). Follow the assembly and installation instructions below, if you wish to hardwire the Madeline Metal chandelier instead of plugging it into a wall electrical outlet, installing the fixture using the optional Pottery Barn conversion kit # **2746766** or **2747343** (included).

Important Safety Instructions:

- These instructions are provided for your safety. It is very important that they are read carefully and completely before beginning the assembly and installation of this lighting fixture.
- We strongly recommend that a professional electrician install all direct wire fixtures.
- THIS PRODUCT MUST BE INSTALLED IN ACCORDANCE WITH THE APPLICABLE INSTALLATION CODES BY A PERSON FAMILIAR WITH THE CONSTRUCTION AND OPERATION OF THE PRODUCT AND THE HAZARDS INVOLVED.
- The lighting fixture is meant for indoor use. It must be connected only to 3-wire, single-phase electrical supply systems (provided with Ground wire or equivalent protection system).
- For your safety, it is strongly recommended that two people install the lighting fixture.
- This fixture has been rated for up to six (6) **25-Watt maximum TYPE B** (not included) or six (6) **5-Watt compact fluorescent light bulbs** (not included) or six (6) 4.5 watt LED bulb (not included) to avoid the risk of fire, do not exceed the recommended lamp wattage.
- The lighting fixture is meant for indoor use, DRY LOCATIONS ONLY.
- **Save these instructions.**



WARNING:

- **To reduce the risk of fire, electrical shock or personal injury, always turn off light fixture and allow it to cool prior to replacing light bulb.**
- **Do not touch bulb when fixture is turned on. Do not look directly at lit bulb.**
- **Keep flammable materials away from lit bulb.**
- **This lighting fixture contains lead, a chemical known to the State of California to cause cancer, birth defects and other reproductive harm. Wash hands after installing, handling, cleaning or otherwise touching this light fixture.**

Pre-assembly:

- Remove all parts and hardware from box along with any plastic protective packaging.
- Do not discard any contents until after assembly is complete to avoid accidentally discarding small parts or hardware.
- For your safety and convenience, assembly by two people is recommended.

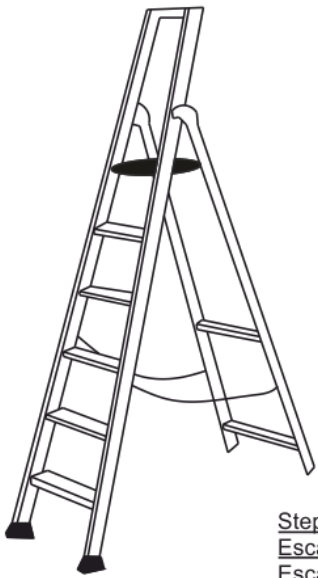
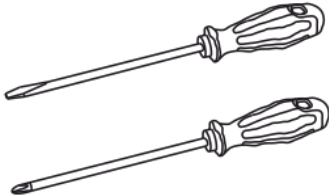

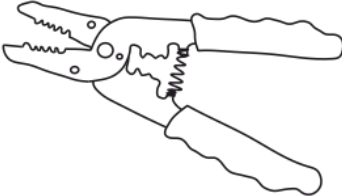
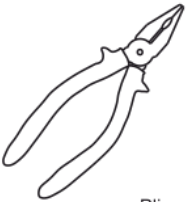

TOOLS REQUIRED (not included)

 <p>Step Ladder Escabeau Escalera</p>	 <p>Phillips, Flat Blade Tournevis Tournevis à tête Phillips et à tête plate Destornilladores Cabeza Phillips y Destornilladores Cabeza Plana</p>	 <p>Electrical tape Ruban isolant Cinta Electrica.</p>
	 <p>Wire Cutter/Stripper Pince coupe-fil/ à dénudé Cortador de Cable</p>	 <p>Plier Pince Alicates</p>

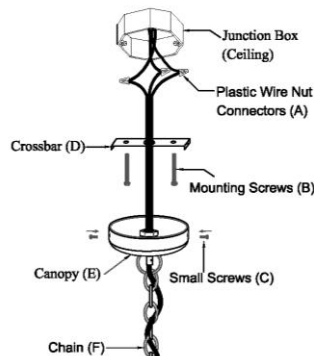
Parts Included:

- (1) Crossbar (D)
- (1) Canopy (E)
- (1) Chain (F)
- (6) Sockets (G)
- (1) Light Fixture (H)
- (1) Green Ground Screw (K)
- (1) Flower (M)



	Plastic Wire Nut Connectors (A) 3
	Mounting Screws (B) 2
	Small Screws (C) 2
	Green Ground Screw (K) 1

Hardware Enclosed:

- (3) Plastic Wire Nut Connectors (A)
- (2) Mounting Screws (B)
- (2) Small Screws (C)

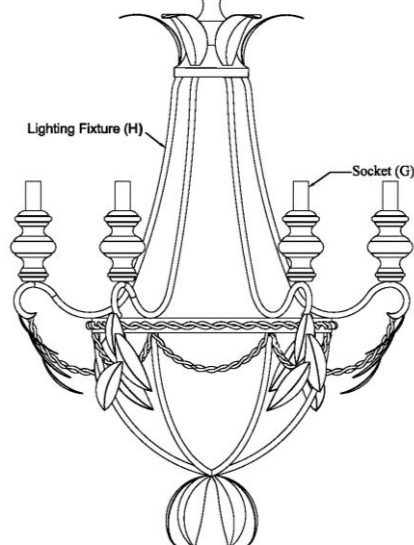

To adjust the suspension length of the fixture:

NOTE: The power cord will need to be cut for hardwire installation, eliminating the plug and switch. Make sure when cutting the cord, to cut the cord allowing enough additional length so that it is at least 6 inches (152.4 mm) long, through the Canopy, within the ceiling outlet junction box (J-box).

Note: The adjustment or shortening of the lighting fixture's suspension length is only needed if the factory set chain length is not appropriate for your installation. We recommend that you adjust the chain to the proper desired length before cutting the electrical cord. Determine the lighting fixture suspension length from the ceiling for the product installation, allowing the extra cord length for the outlet junction box wire connections as noted below.

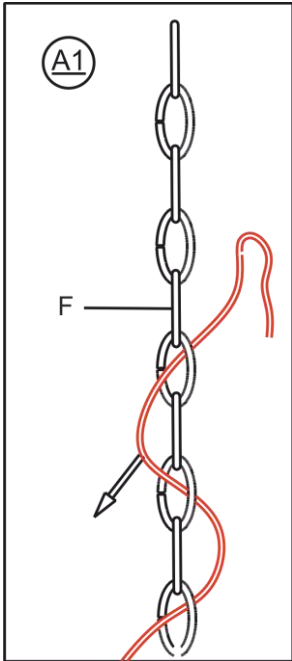

(See A1) Pull out the fixtures 2 wire power cord and green ground wire woven through the Chain (F).

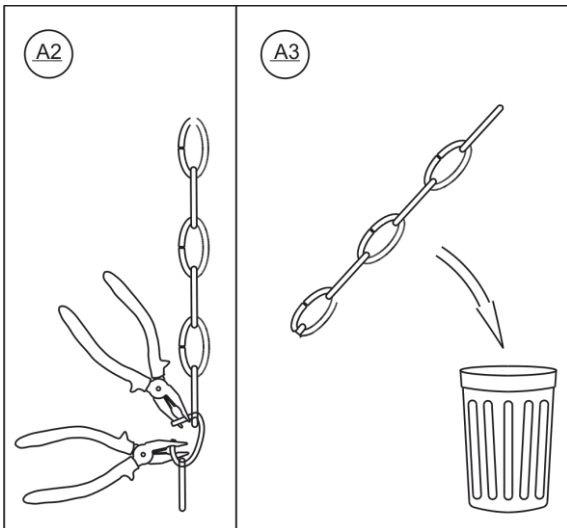

(See A2 & A3) The chain length may be shortened from either end. Use two pairs of pliers to gently pry the link apart along a split-line formed in each link so that a space is created large enough for the link to be removed from the remaining chain. Use a cloth or folded piece of paper between the pliers and the link to protect the finish of the link during bending.

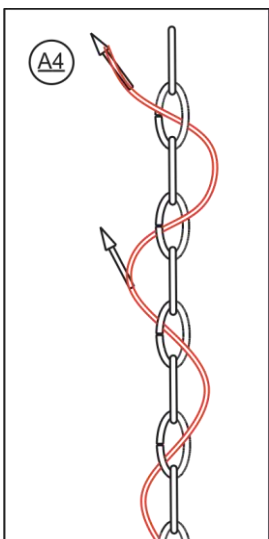

(See A4) Re-weave the fixtures 2 wire power cord and green ground wire through every other loop to the top of Chain (F).

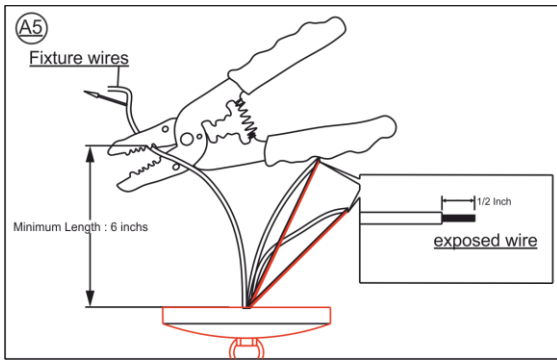

(See A5) If needed, cut off the extra power cord length on the 2 wire cord and green ground wire so that they all are at least 6 inches (152.4 mm) long within the outlet junction box (J-box).

Assembly & Installation Instructions:

- **SHUT OFF THE MAIN ELECTRICAL SUPPLY FROM THE MAIN FUSE BOX/CIRCUIT BREAKER.**
- Carefully unpack all fixture parts and hardware and lay them on a clear workspace.

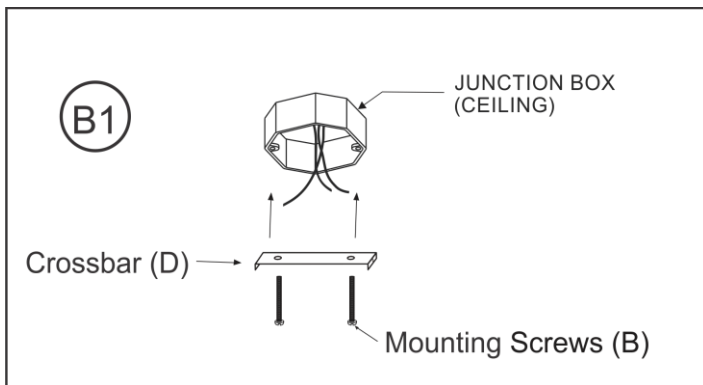

Tighten Crossbar (D) on Ceiling Junction box with the help of Mounting Screws (B)

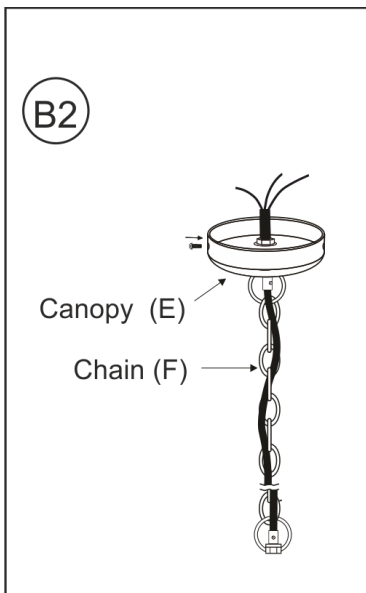

Weave the fixtures power cord and green ground wire through every other loop to the top of Chain (F) and then through the Canopy (E).

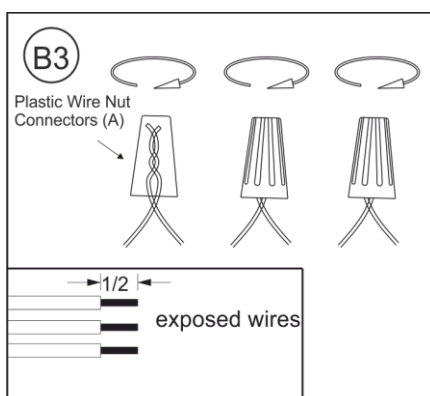

Please read the section "To Make the Wire Connections" Below.

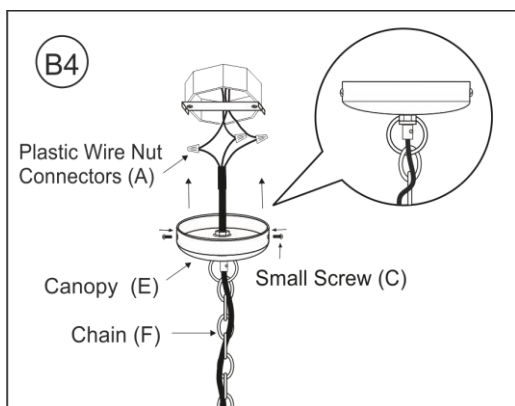

Slide the Canopy (E) upward. Align the Canopy holes with the Crossbar holes and tighten the small screws (C) by turning in clockwise direction until secure.

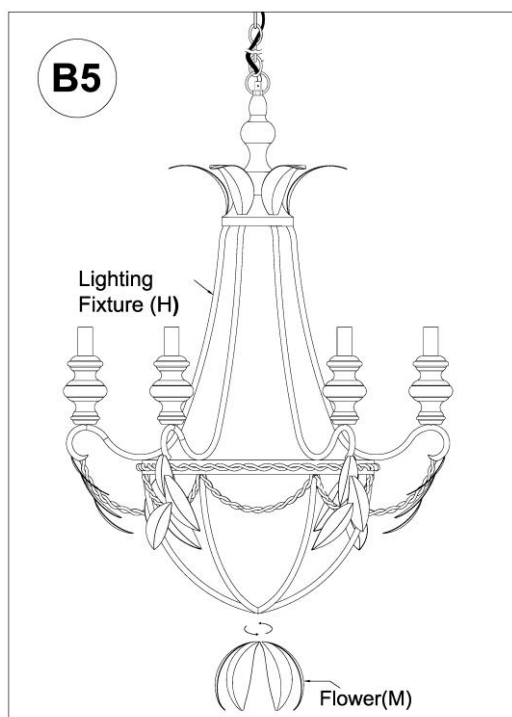

Insert Flower (M) into fixture (H) by screwing clockwise direction until secure/fix.

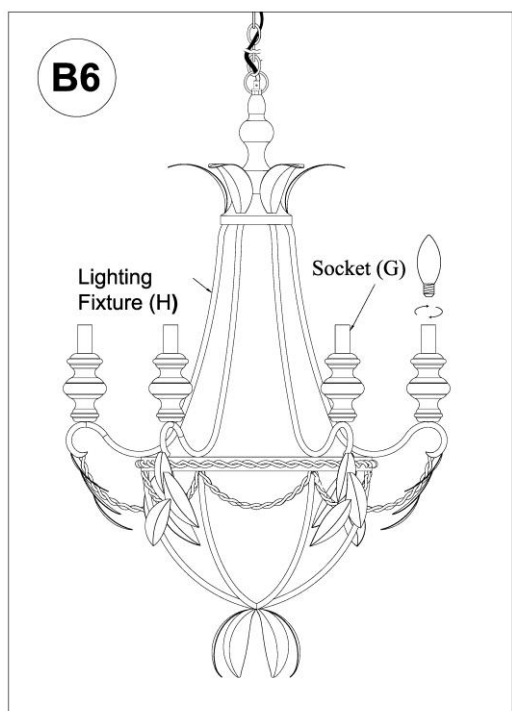

Insert the specified light bulbs into each Socket (G). DO NOT EXCEED THE SPECIFIED WATTAGE.

To Make the Wire Connections:

1. Gently pull existing wire down from the ceiling junction box and allow wires to hang. The HOT or LIVE wire is usually black. The NEUTRAL wire is usually white. Check to see if there is a ground wire that is usually green or green with a yellow stripe or exposed copper metal wire. If needed, use a pair of wire strippers to remove about 1/2 inch of insulation from each wire.
2. Carefully inspect the fixtures wires. The NEUTRAL FIXTURE WIRE is WHITE. The HOT FIXTURE WIRE is BLACK and the GREEN WIRE is the GROUND WIRE. If you have any doubt and cannot identify the power-supply wires with confidence, then we recommend that you ask an electrician and that you not continue with the installation.
3. With the help of another person to hold the weight of the fixture, attach the fixture wires to the junction box wires as shown in the illustrations.

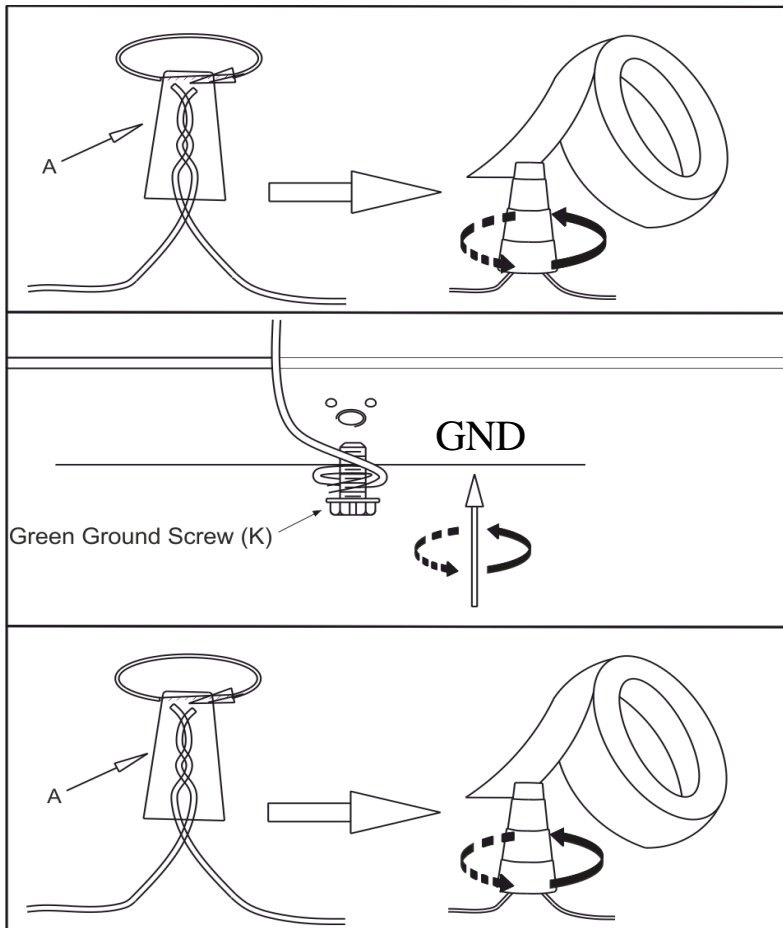

Connect the GROUND FIXTURE WIRE to the GROUND J-BOX WIRE using the Plastic Wire Nut Connector (A) and wrap the connection with electrical tape. Be sure that no wire strands are exposed.

If the junction box DOES NOT have a GROUND WIRE, wrap the fixture's green ground wire around the Green Ground Screw (K) and insert the screw into the Crossbar (D), marked as "GND", and tighten screw to secure the wire.

Connect the NEUTRAL FIXTURE WIRE to the NEUTRAL J-BOX WIRE first and then connect the HOT FIXTURE WIRE to the HOT J-BOX WIRE using the Plastic Wire Nut Connectors (A). Wrap these connections with electrical tape. Be sure that no wire strands are exposed.

NOTE:

IT IS IMPERATIVE THAT THE JUNCTION BOX IN YOUR HOME BE PROPERLY GROUNDED!

DO NOT REVERSE THE HOT AND NEUTRAL CONNECTIONS OR SAFETY WILL BE COMPROMISED.

4. Check the wiring connections and if all looks good, gently tuck the wire connections neatly into the ceiling junction box.

Care instructions:

- Wipe clean with a soft, dry cloth or static duster.
- Always avoid the use of harsh chemicals or abrasive cleaners as they may cause damage to the fixture's finish.

Thank you for your purchase

[Stores / Catalog / www.potterybarn.com](http://www.potterybarn.com)

USA 1.800.290.8181